

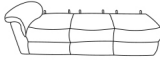

ASSEMBLY INSTRUCTION

| Part No.: | DRAWNG | PART NAME | QTY(PCS) | Part No.: | DRAWNG | PART NAME | QTY(PCS) |
|-----------|---|-------------|----------|-----------|---|-----------|----------|
| A |  | LEFT BACK | 1 | D |  | SOFA BASE | 1 |
| B |  | RIGHT BACK | 1 | E |  | LEFT EAR | 1 |
| C |  | MIDDLE BACK | 1 | | | | |

Please take out "E" from bottom of the sofa.

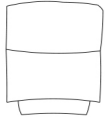

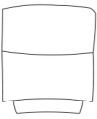
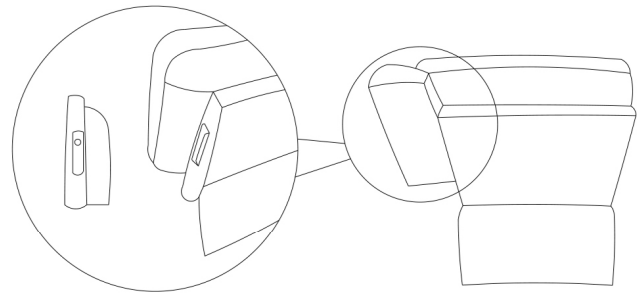
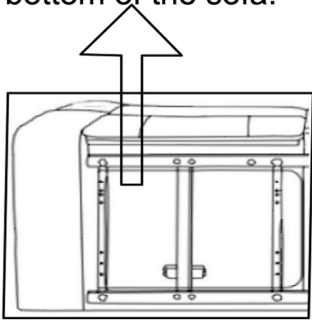
STEP 1 EARS

Align the male and female brackets on the ear and back, and push down tightly to secure

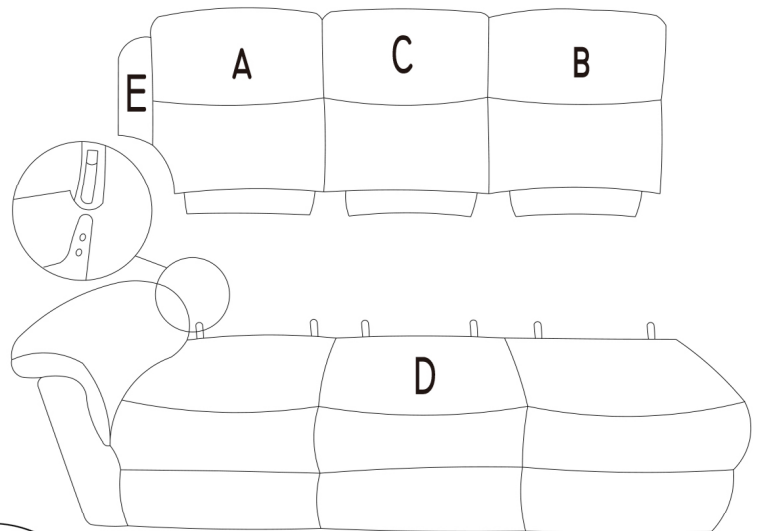

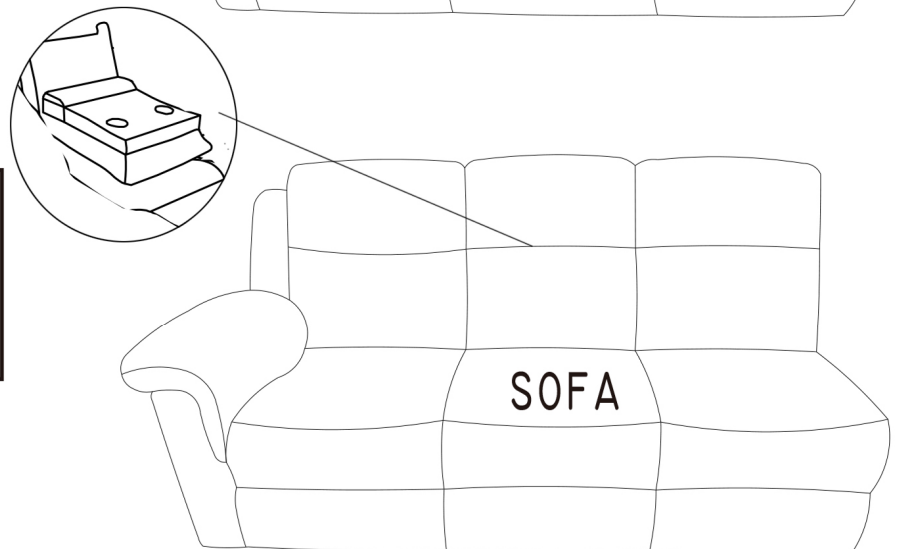

STEP 2 BACKS

Align the male and female brackets on the base and back, and push down tightly to secure

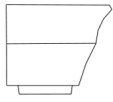
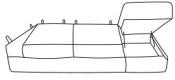
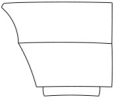

ASSEMBLY INSTRUCTION

| Part No.: | DRAWNG | PART NAME | QTY(PCS) | Part No.: | DRAWNG | PART NAME | QTY(PCS) |
|-----------|---|-------------|----------|-----------|---|-------------|----------|
| A |  | LEFT BACK | 1 | D |  | Chaise base | 1 |
| B |  | RIGHT BACK | 1 | E |  | Legs | 4 |
| C |  | MIDDLE BACK | 1 | | | | |

STEP 1 BACKS

Align the male and female brackets on the base and back, and push down tightly to secure

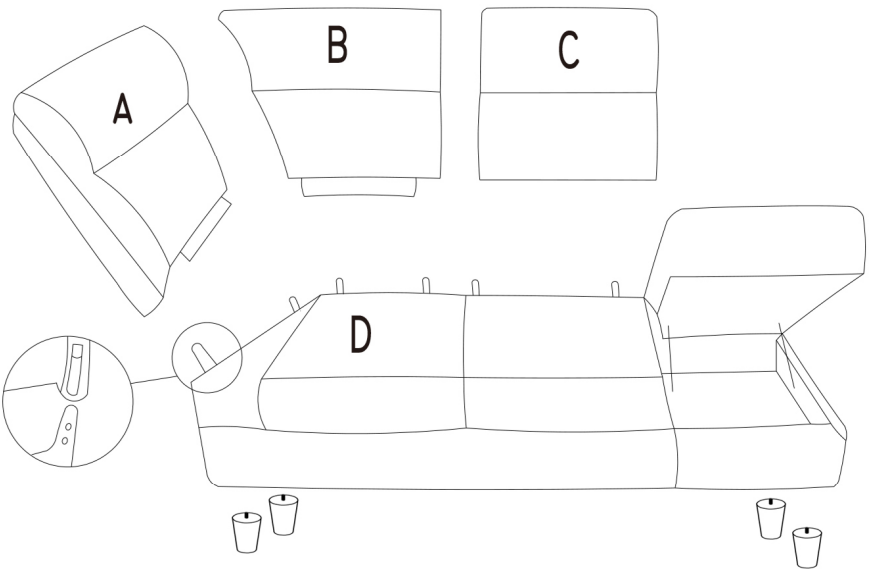
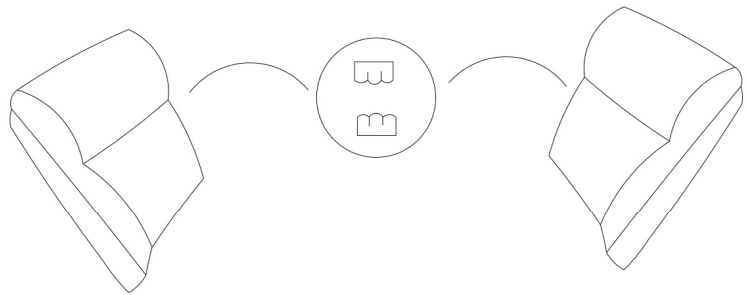

STEP 2 Assemble the legs

STEP 3 Connect the sofa

