











Assembly Instructions

Caution : You must read this before you proceed

Care & Maintenance

- ⊘  ● Not for commercial use. For residential use only.
 - ✓  ● Furniture may scratch floors. We recommend using furniture pads to protect your floors.
 - ⊘  ● Do not put hot items directly on furniture surface.
 - ⊘  ● Do not clean furniture with harsh cleansers or polish.
 - ⊘  ● Do not place furniture under direct sunlight.
 - ⊘  ● Do not place furniture near heating or cooling vents.
 - ⊘  ● Do not write on furniture without a padded barrier to protect the surface.
 - ⊘  ● Do not place furniture outside . For indoor use only.
 - ⊘  ● Stains may be removed with mild soap solution and damp cloth.
 - ⊘  ● Children should not climb or jump on the furniture.
- ✓  ● Dust and pick-up spills using a clean, non-colored, lint-free cloth.

Please inspect the integrity of the pillows and sofas in the cardboard box.

SECTIONALS

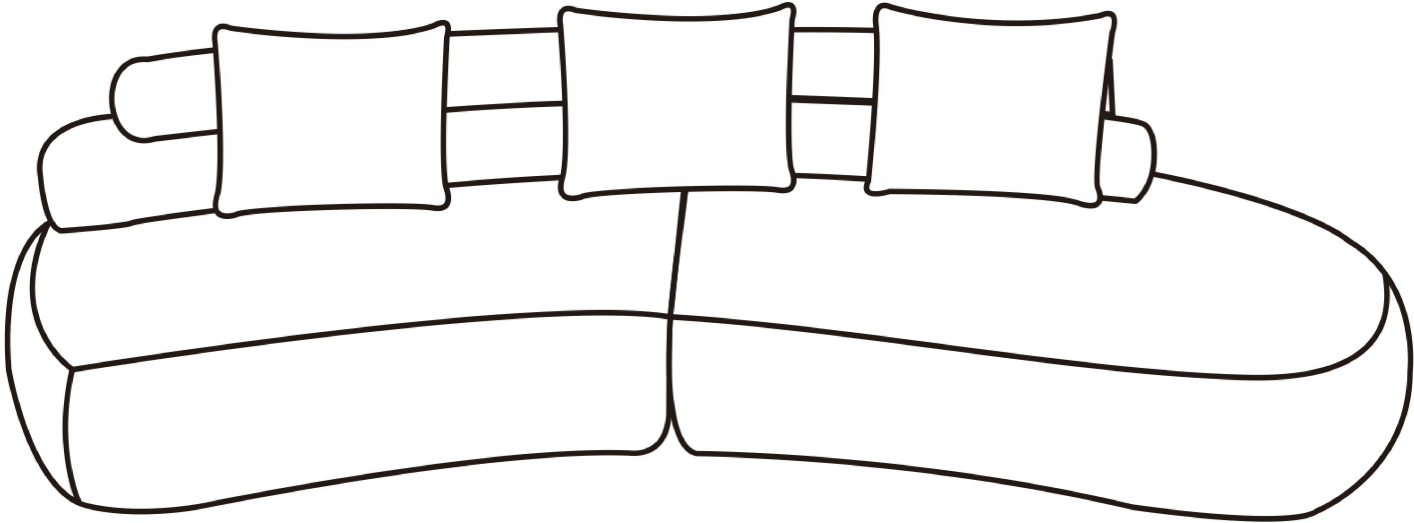

Parts List

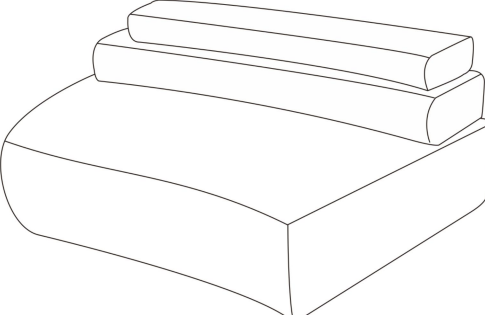
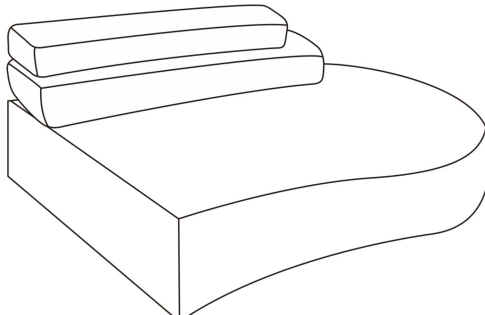
Label	Picture	Description	QTY
A		Left-Side Sponge Sofa	1
B		Right-Side Chaise	1

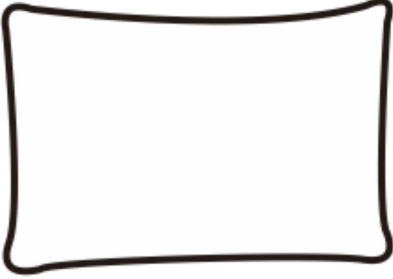
C		Cushion	3
---	---	---------	---

Hardware

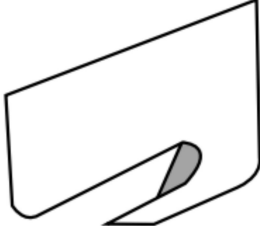
Label	Picture	Description	QTY
①		Blades	1

Assembly Preparation

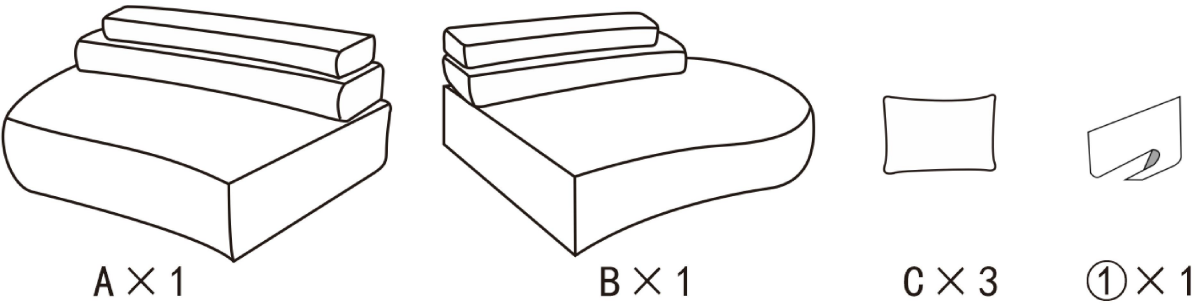
<p>Before Beginning Assembly:</p>	 <p>A X 1 B X 1 C X 3 ① X 1</p>			
-----------------------------------	--	--	--	--



- Read instructions, cover to cover-



- Have 2 adults on hand for assembly-



- Do not assemble on flooring or carpet-



- Assemble on a clean non-marring surface (packing foam)-



- Save all packaging until finished-

Assembly Steps

Overview

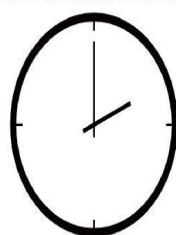
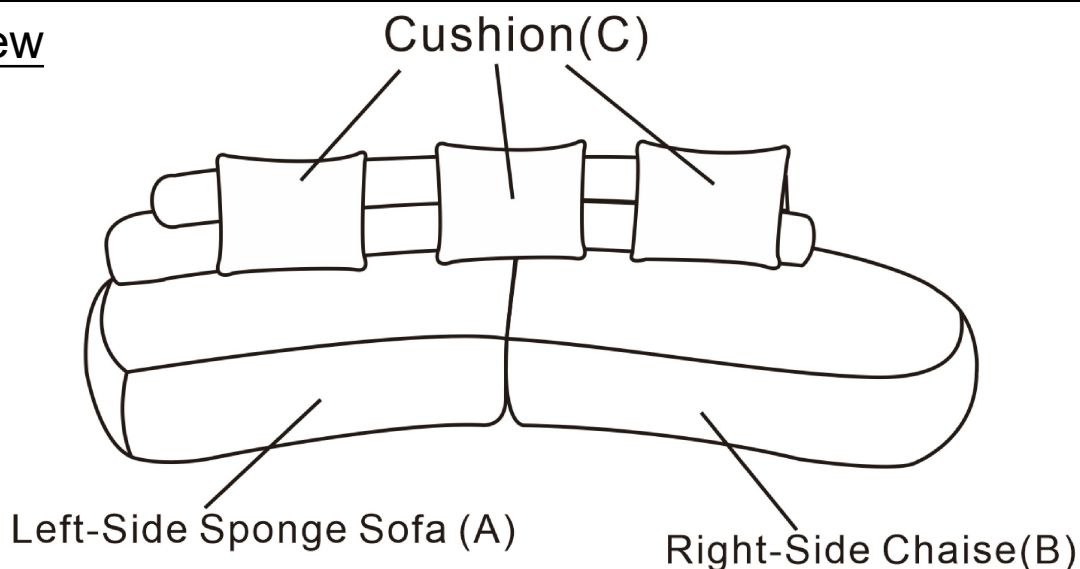

... Wait **72h**

After opening the compression bag (Note: Please do not cut with a knife, so as not to damage to the product), the corners around the cushions if there are wrinkles, you need to wait for about 72 hours, it is recommended that guests pat and knead the corners of the sofa, in order to sponge better recovery.

If you need any help, please take a picture and contact the seller.

Step 1

Cardboard box2-1

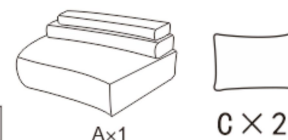
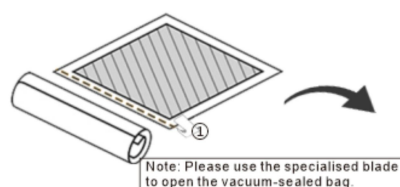
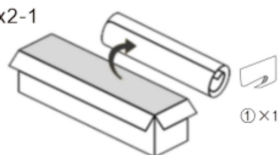

Take the compressed package out of Carton 2-1, spread the compressed bag evenly, cut along one side of the package with a knife, take out Left-Side Sponge Sofa (A) and Cushion (C), and place them on a clean, flat and scratch-free surface.

Step 2

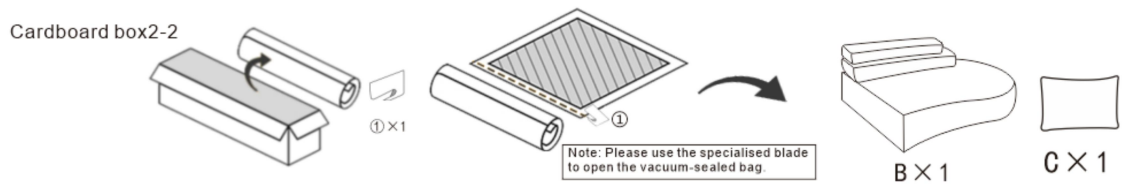

Take the compressed package out of Carton 2-2, spread the compressed bag evenly, cut along one side of the package with a knife, take out Right-Side Chaise (B) and Cushion (C), and place them on a clean, flat and scratch-free surface.

Step 3

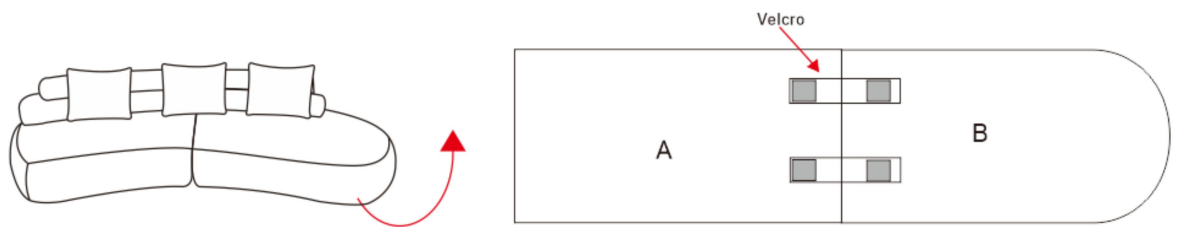

Turn the sofa over and fasten the Velcro on Left-Side Sponge Sofa (A) to that on Right-Side Chaise (B).

Step 4

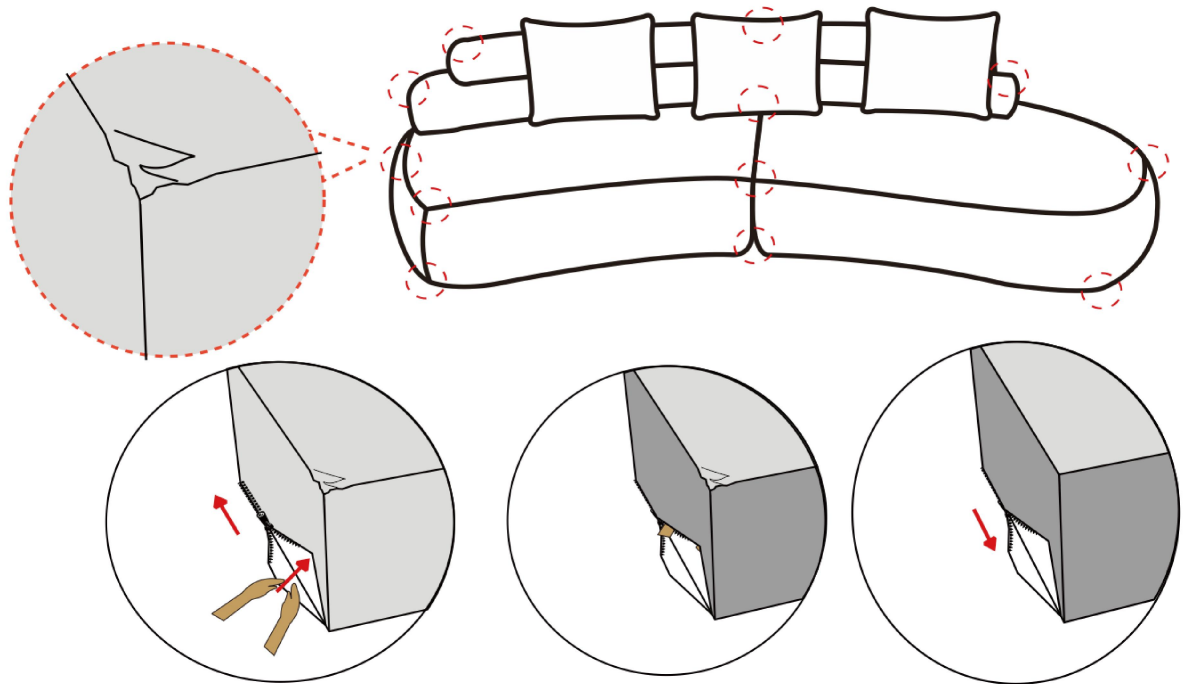

If you see the folds, Unzip the bottom of the product, Put your hand in, Gently pat and knead to tidy up the creased sponge, Wait for the sponge to become full and flat before Zip up the bottom of the product.

Step 5

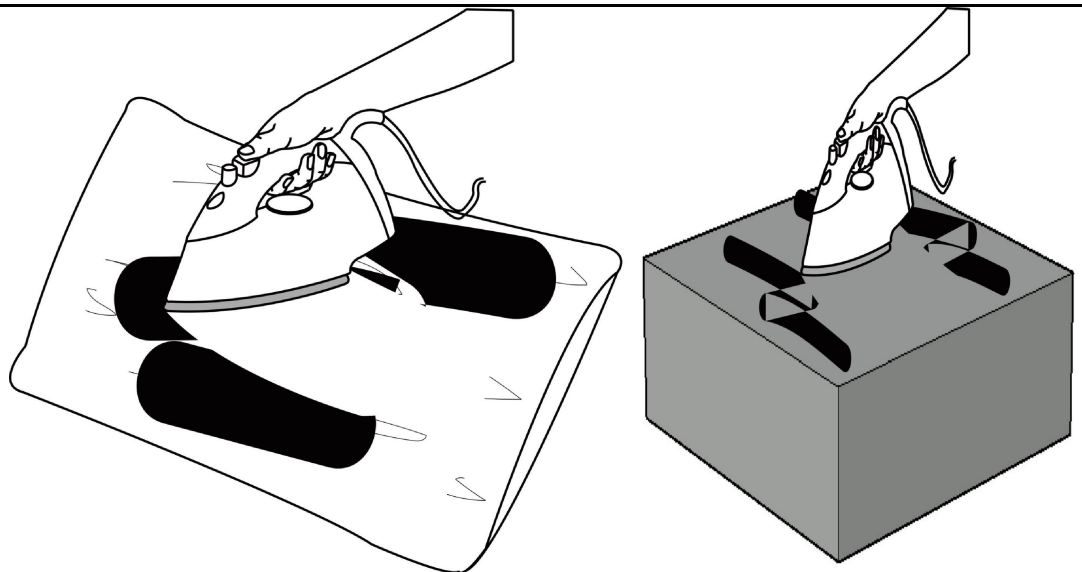

Partial wrinkles on the surface of the fabric can be smoothed out with an iron.