

# ASSEMBLY INSTRUCTION

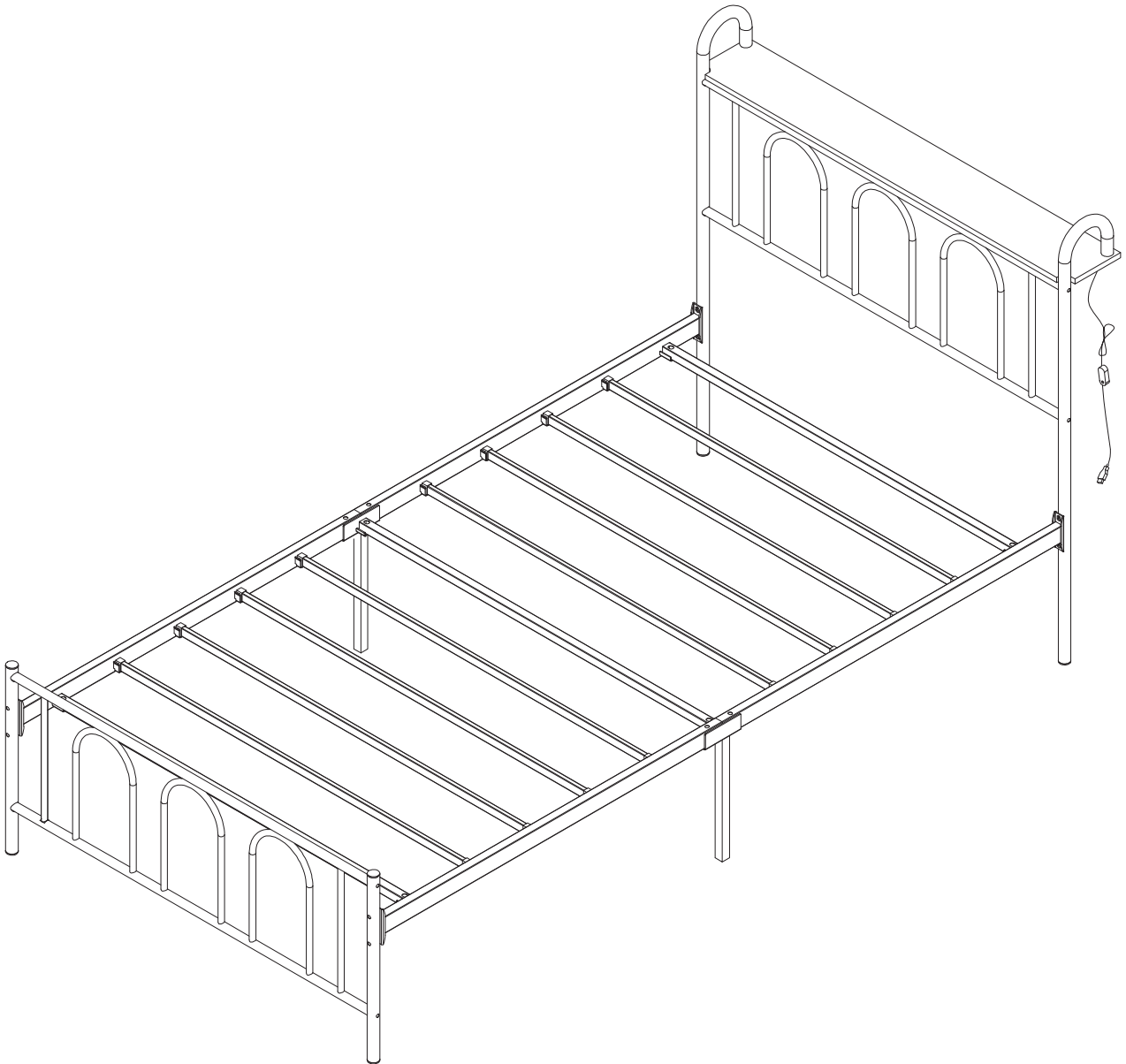



# WARNING

Need Two Or More People To Complete

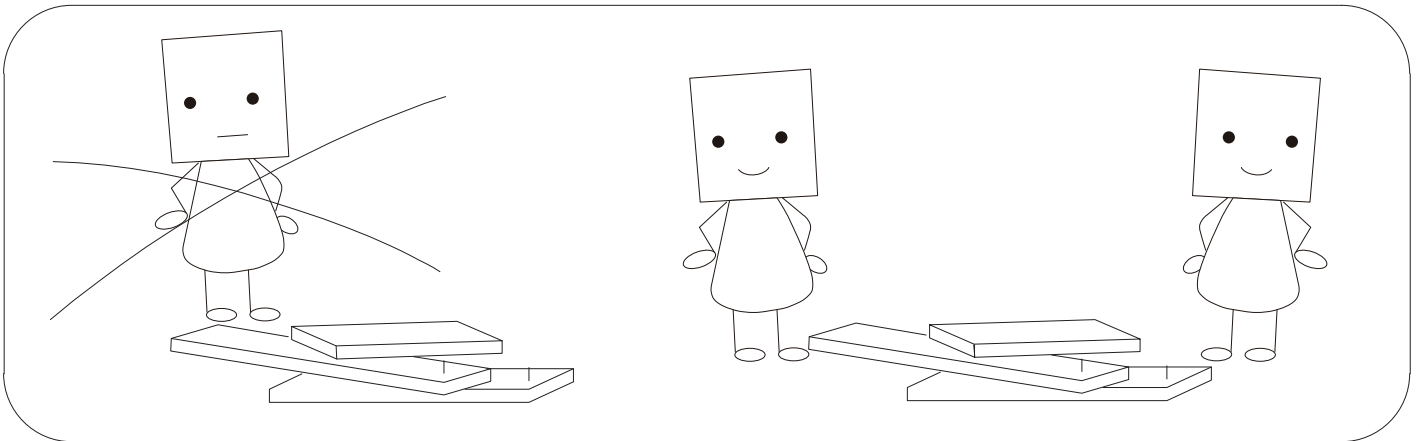

Assemble Item On a Clean Flat Surface

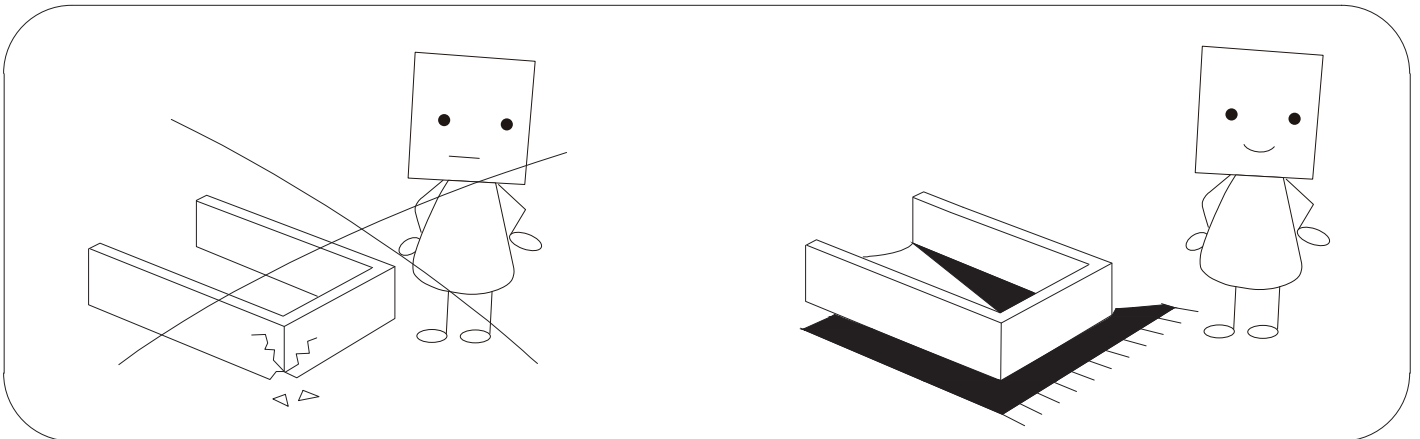

- Please check you have all hardware before assembling.
- Please ensure you have the name of the item and hardware part required and quantity.
- If you have any questions, please contact us by original purchase platform.  
we will reply you ASAP.

# EXPLODED DRAWING:

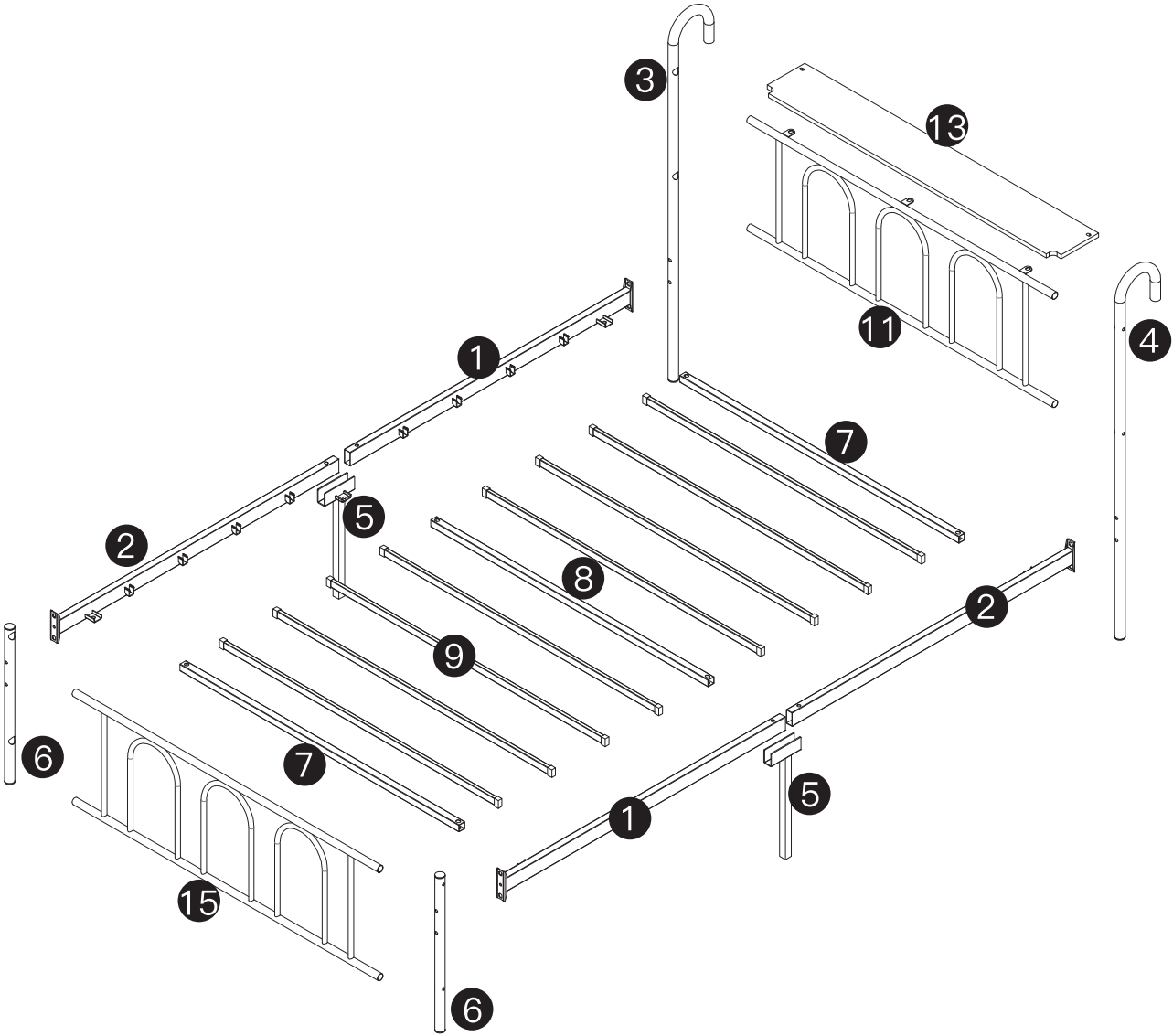
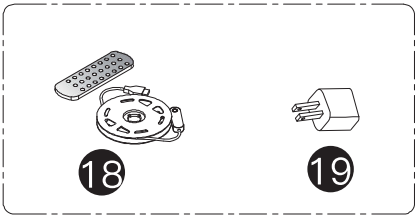

Please check all parts and accessories according to the parts list before assembling, make sure all contents are sufficient and in good condition.

If there is any parts missing or defective, please contact us with purchase platform message immediately to get replacement parts.

## PARTS:

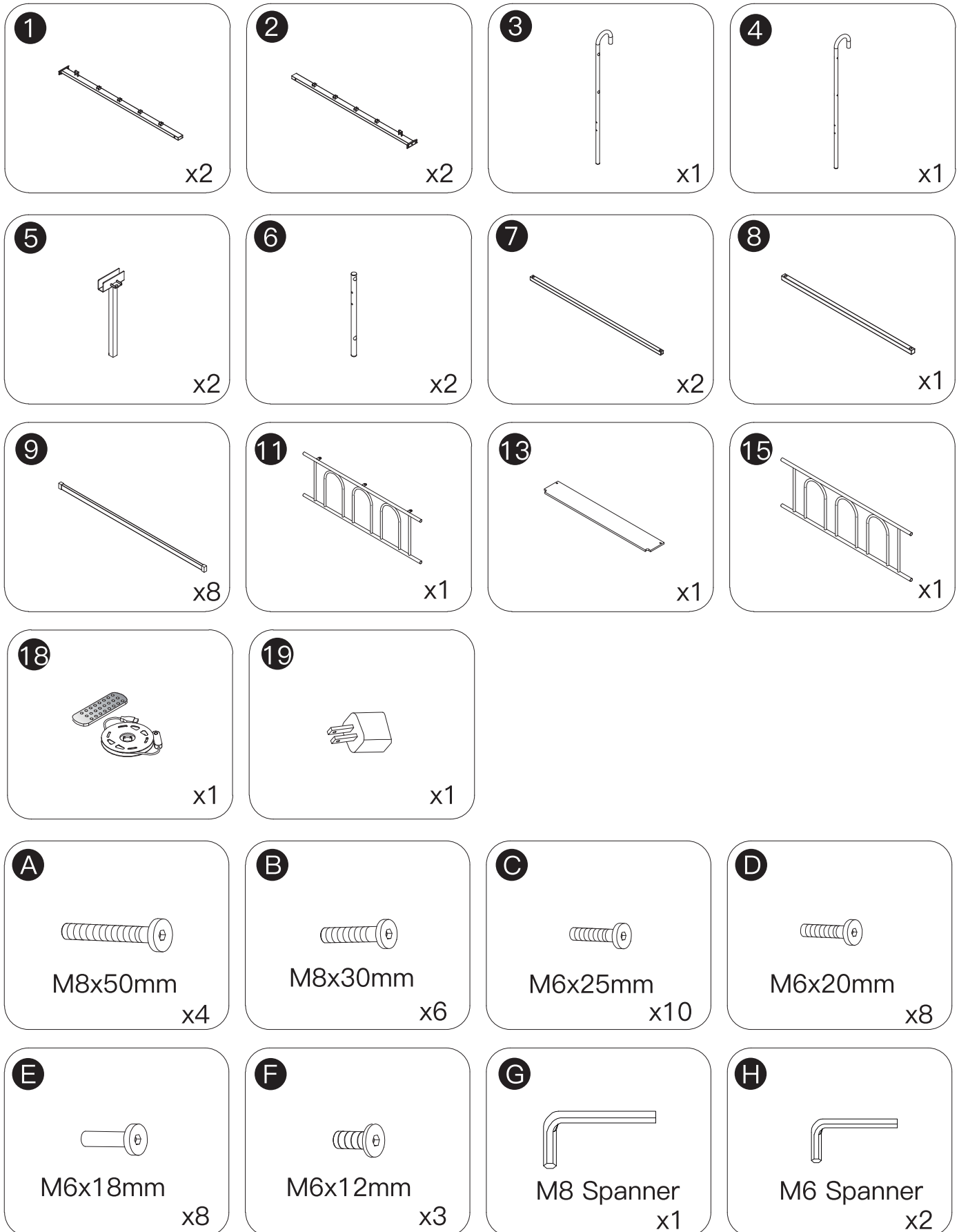

# HOW TO INSTALL

## STEP 1

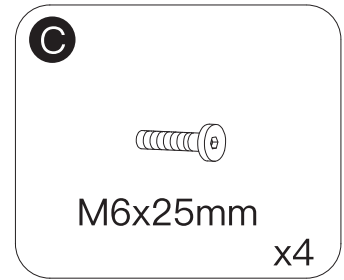
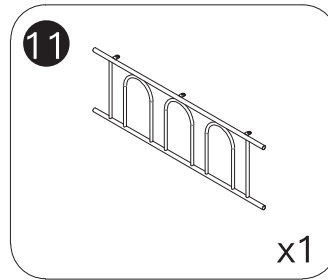
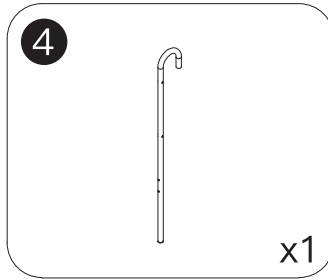
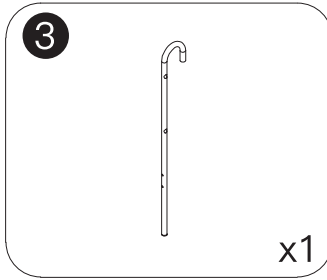

### NOTICE:

(1) Please ensure that the iron sheet of part 11 are facing upwards.

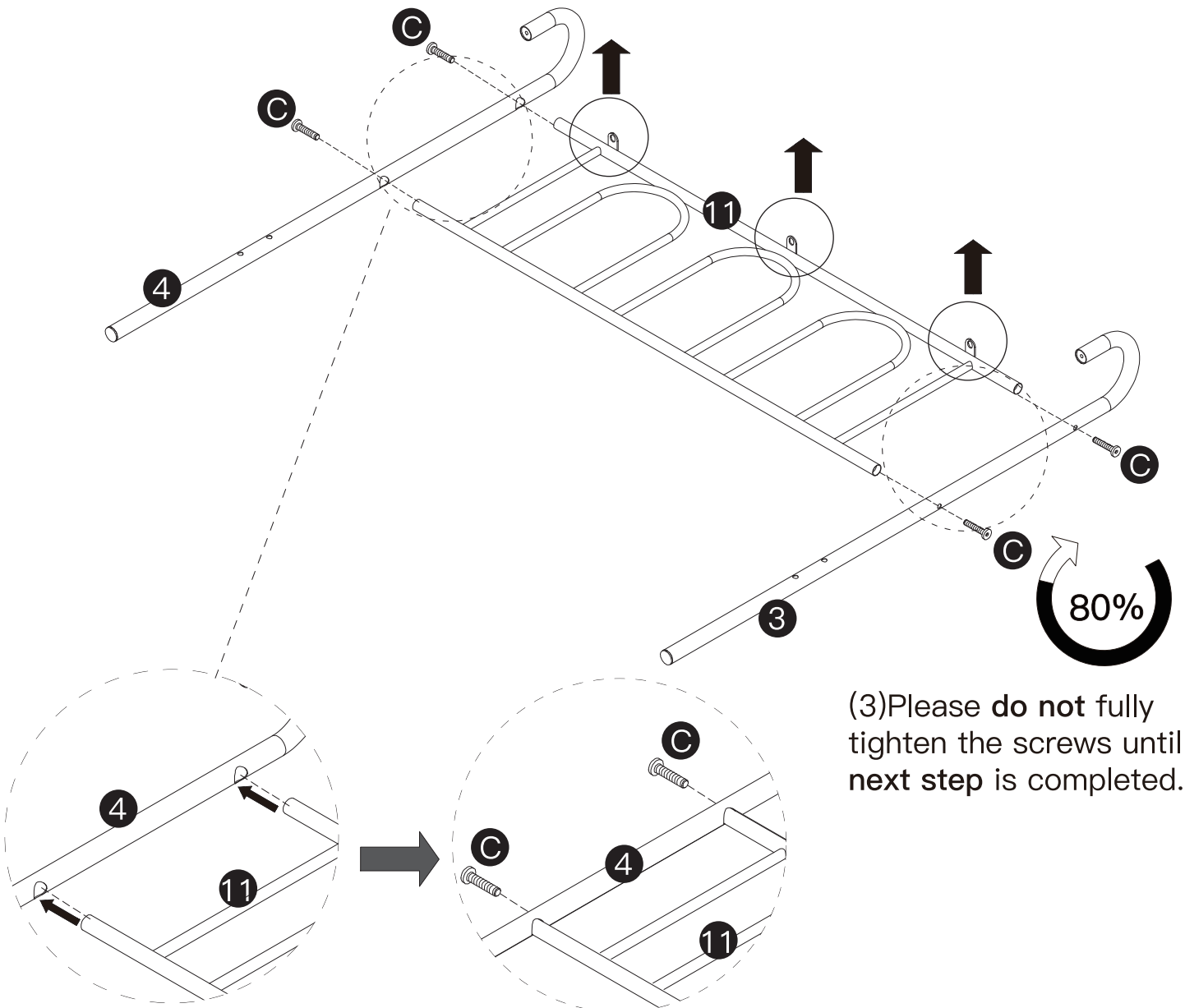

(2) Please **fully** embed part 11 into part 3 & 4 before installing the screws.

(3) Please do not fully tighten the screws until next step is completed.

# STEP 2

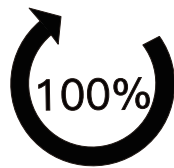
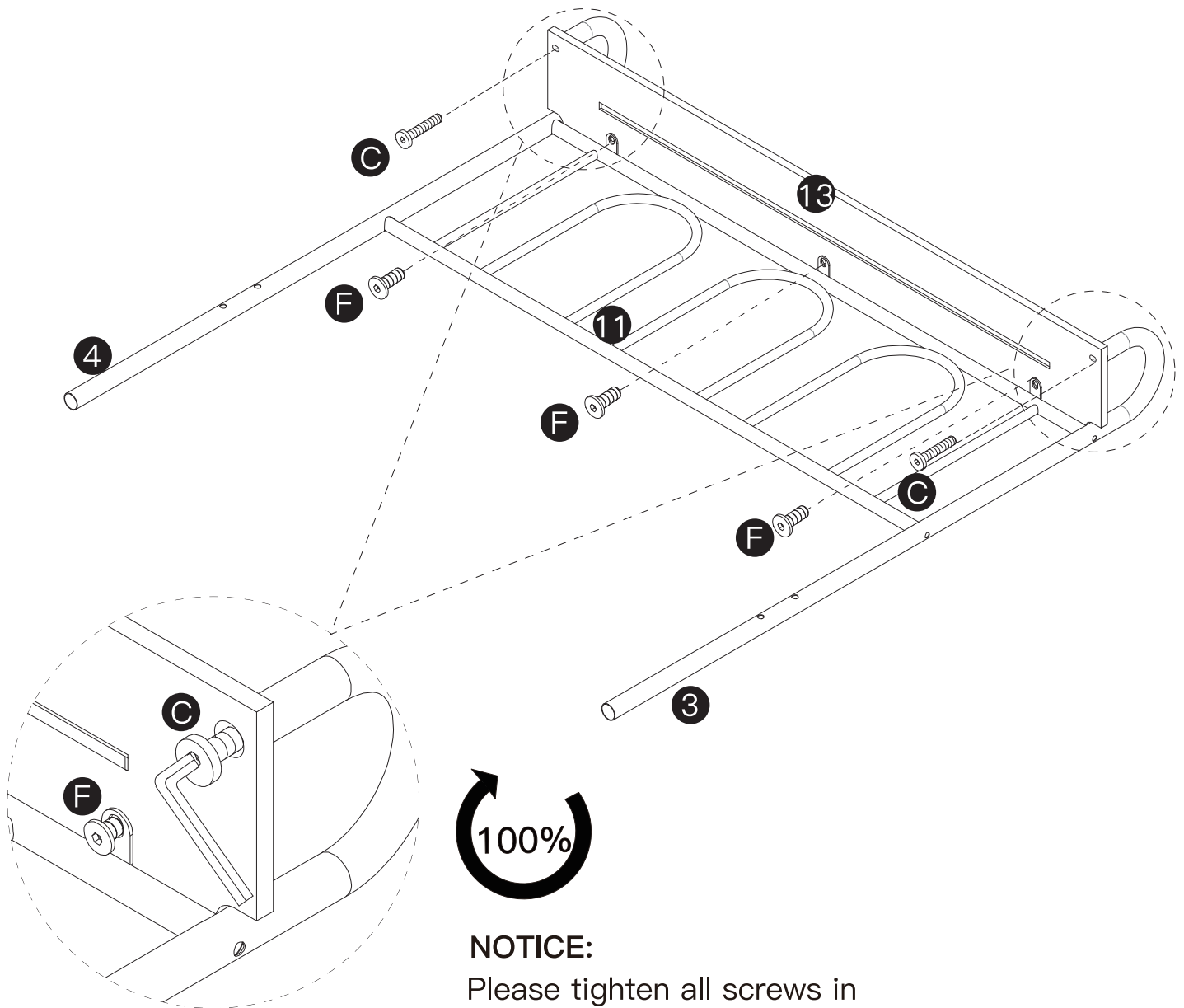
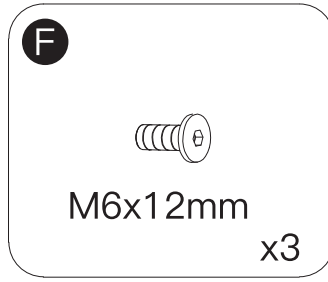
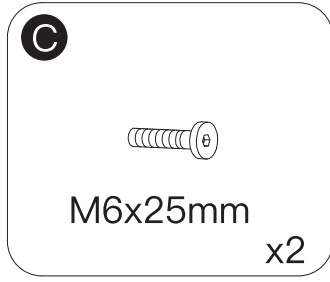
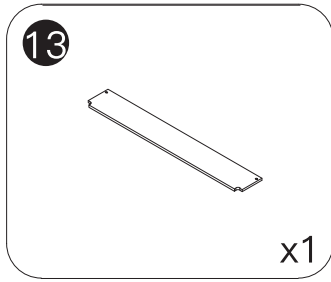

**NOTICE:**  
Please tighten all screws in  
the step.

# STEP 3

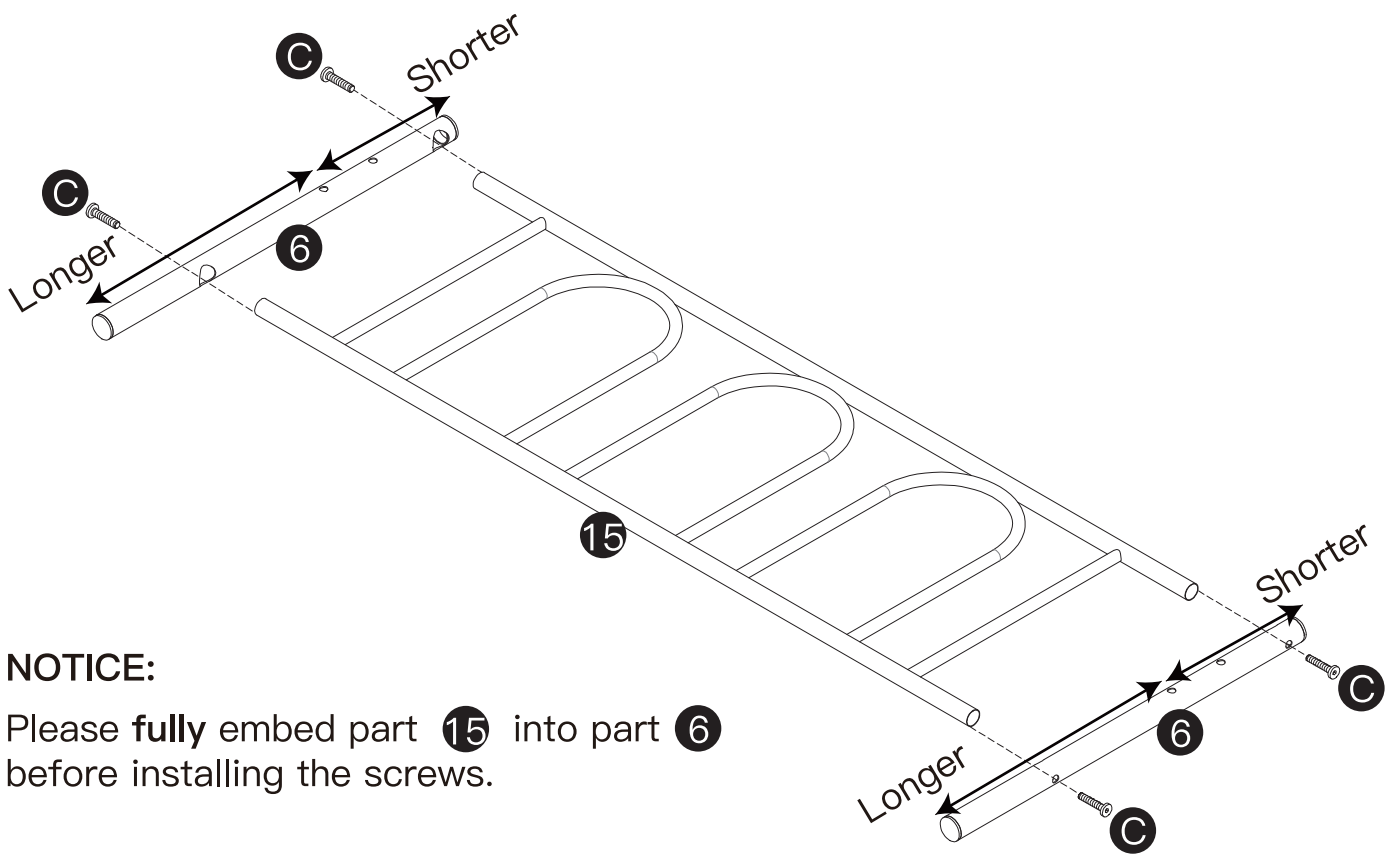
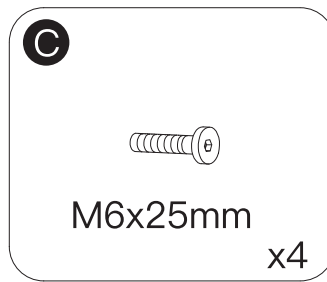
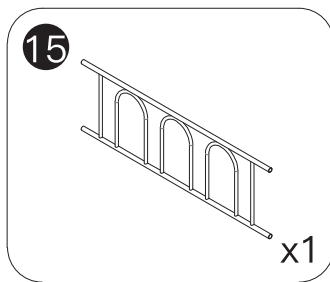
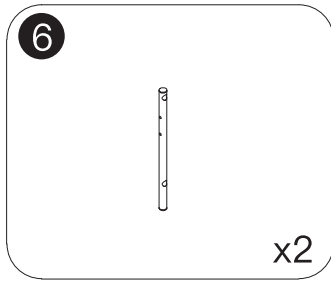

## NOTICE:

Please **fully** embed part 15 into part 6 before installing the screws.

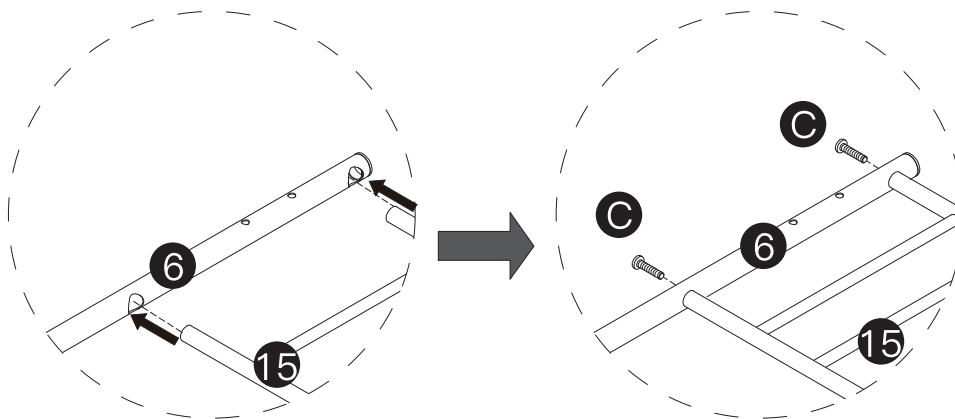

# STEP 4

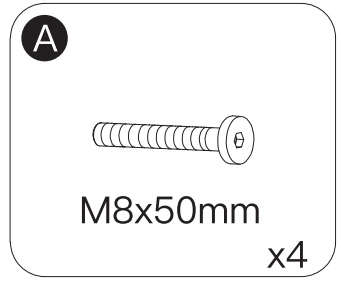
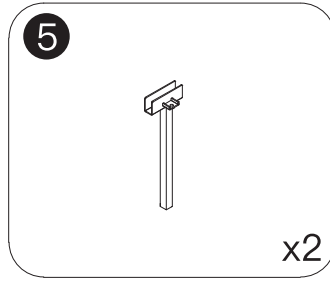
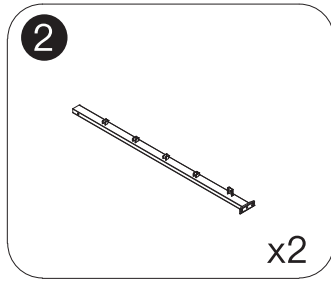
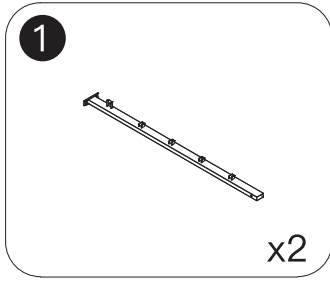

## NOTICE:

Please ensure that the orientation of the notch on part 5 is consistent with the notches of part 1 & 2.

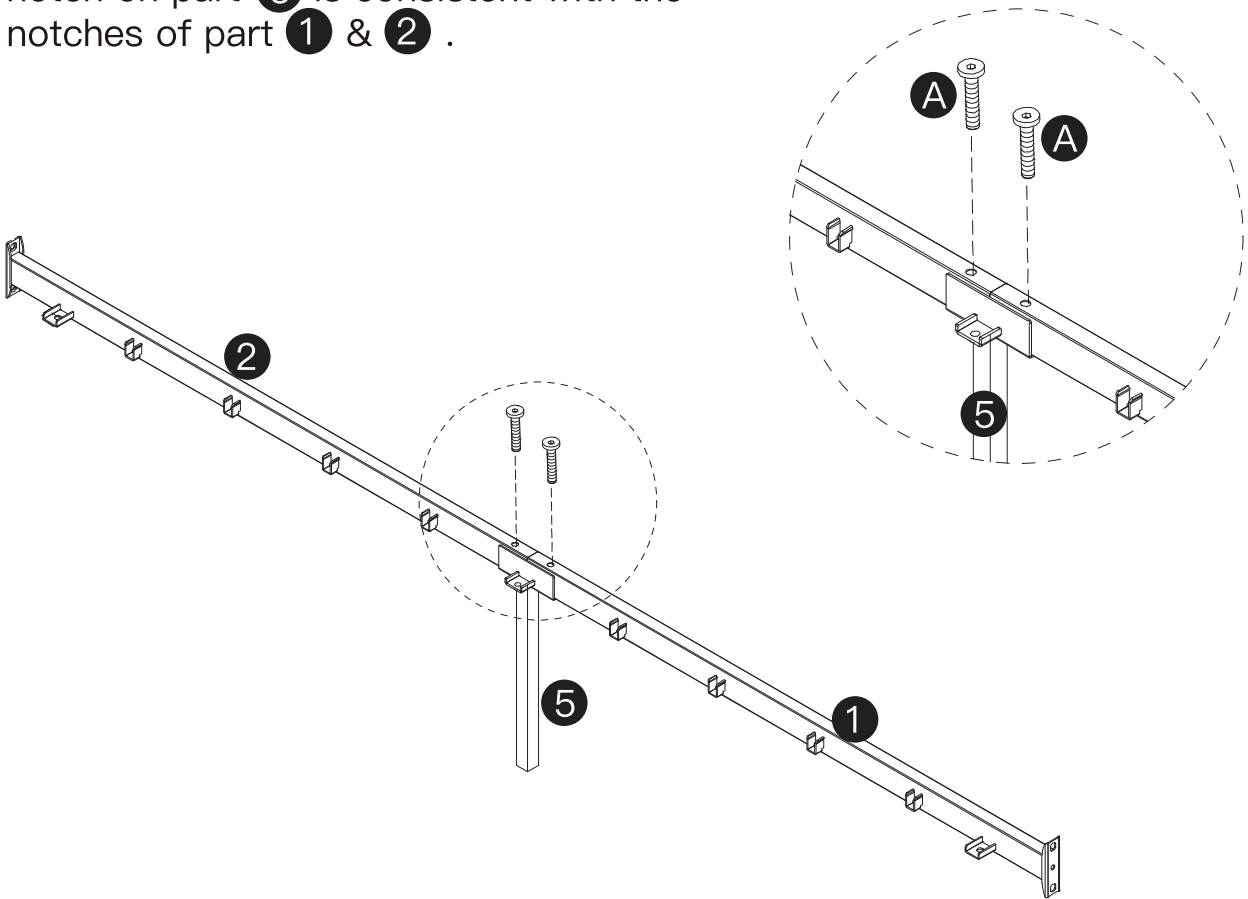

x2

# STEP 5

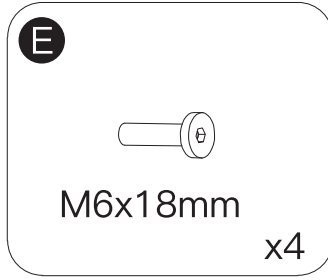
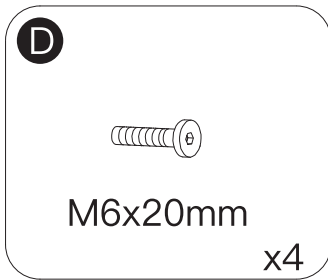

(2) Secure part **D** first with hex screwdriver, then lock it with part **E**.

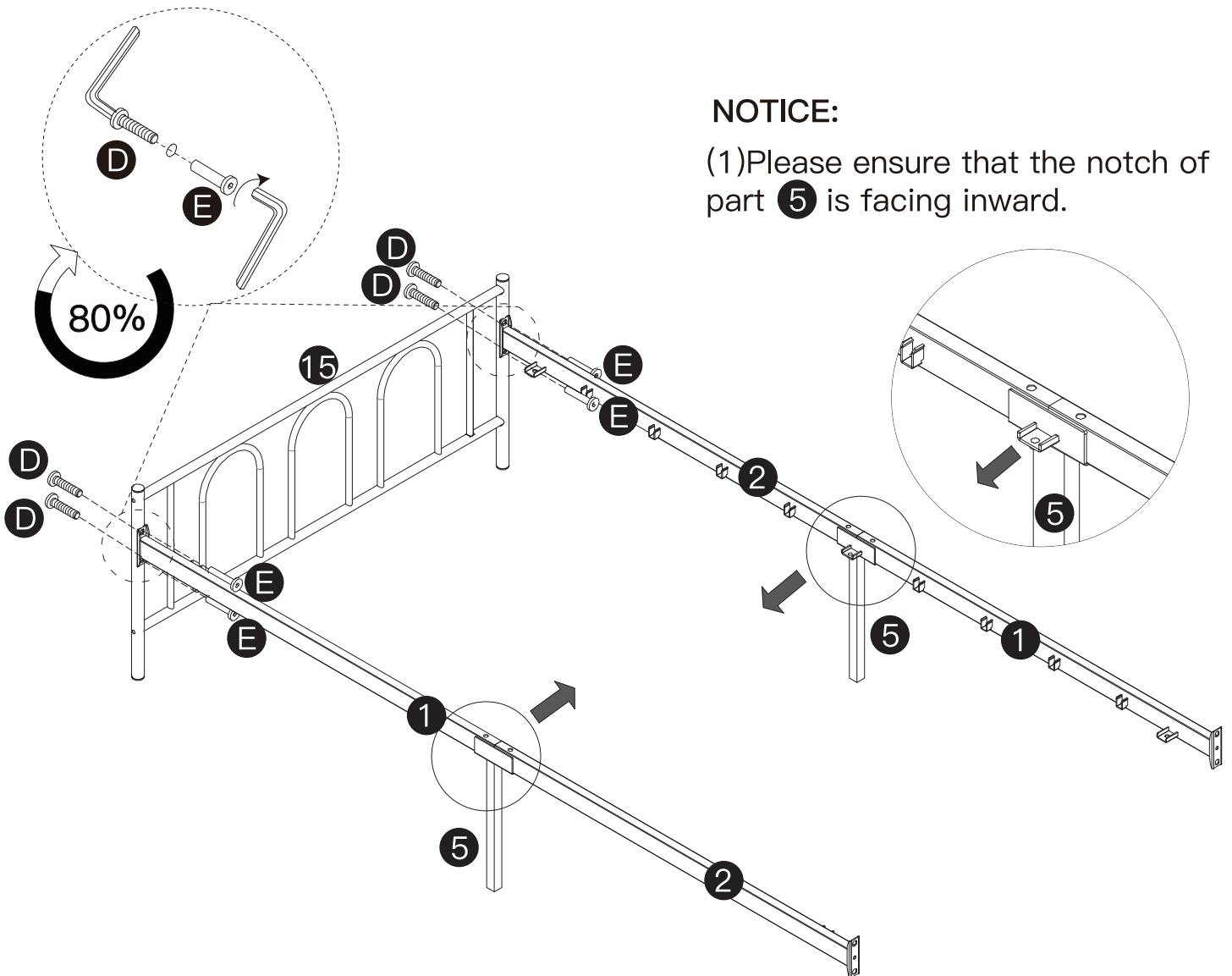

(3) Please **do not** fully tighten the screws until Step 8 is completed.

# STEP 6

**D**

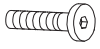

M6x20mm

x4

**E**

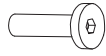

M6x18mm

x4

## NOTICE:

(1) Secure part **D** first with hex screwdriver, then lock it with part **E** .

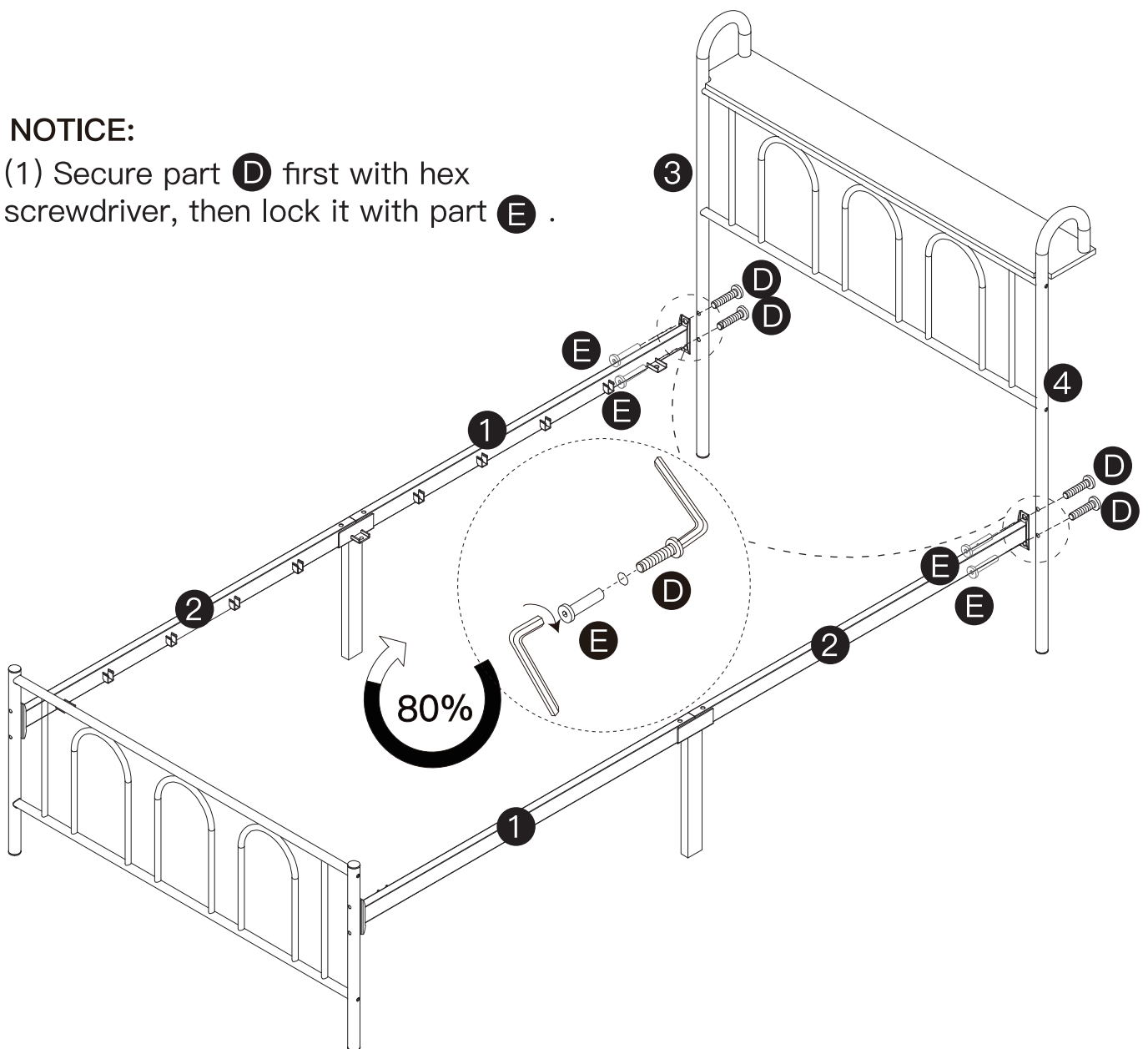

(2) Please do not fully tighten the screws until Step 8 is completed.

# STEP 7

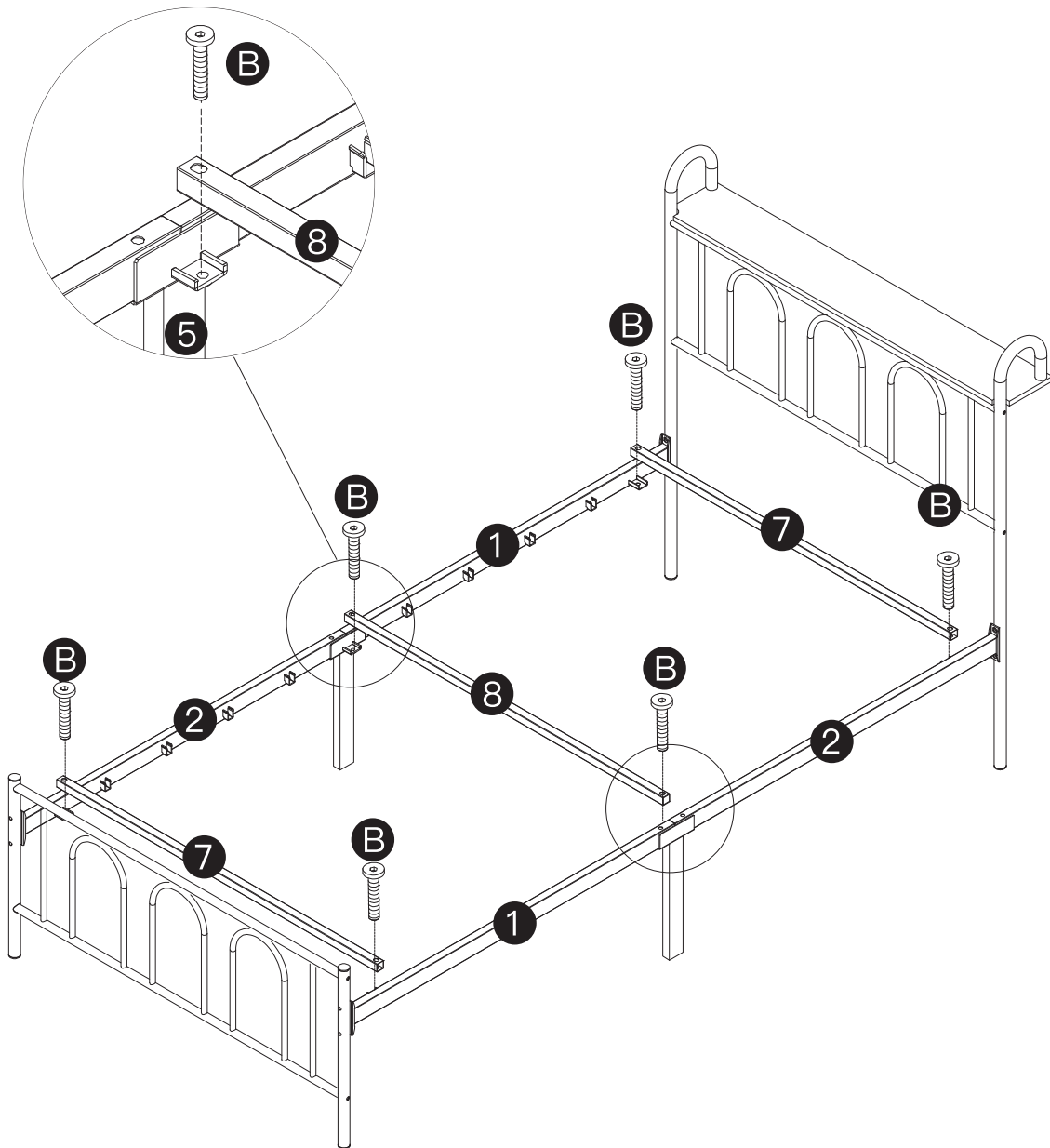
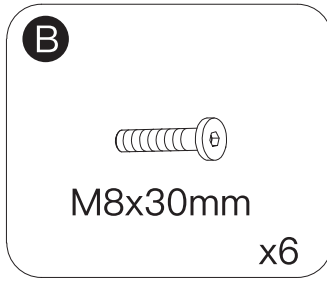
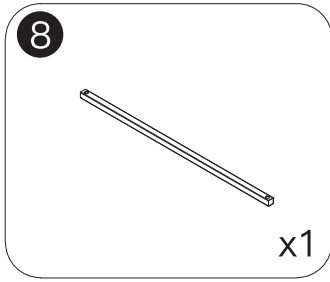
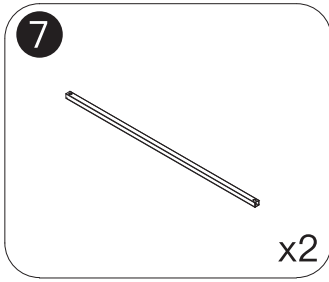

# STEP 8

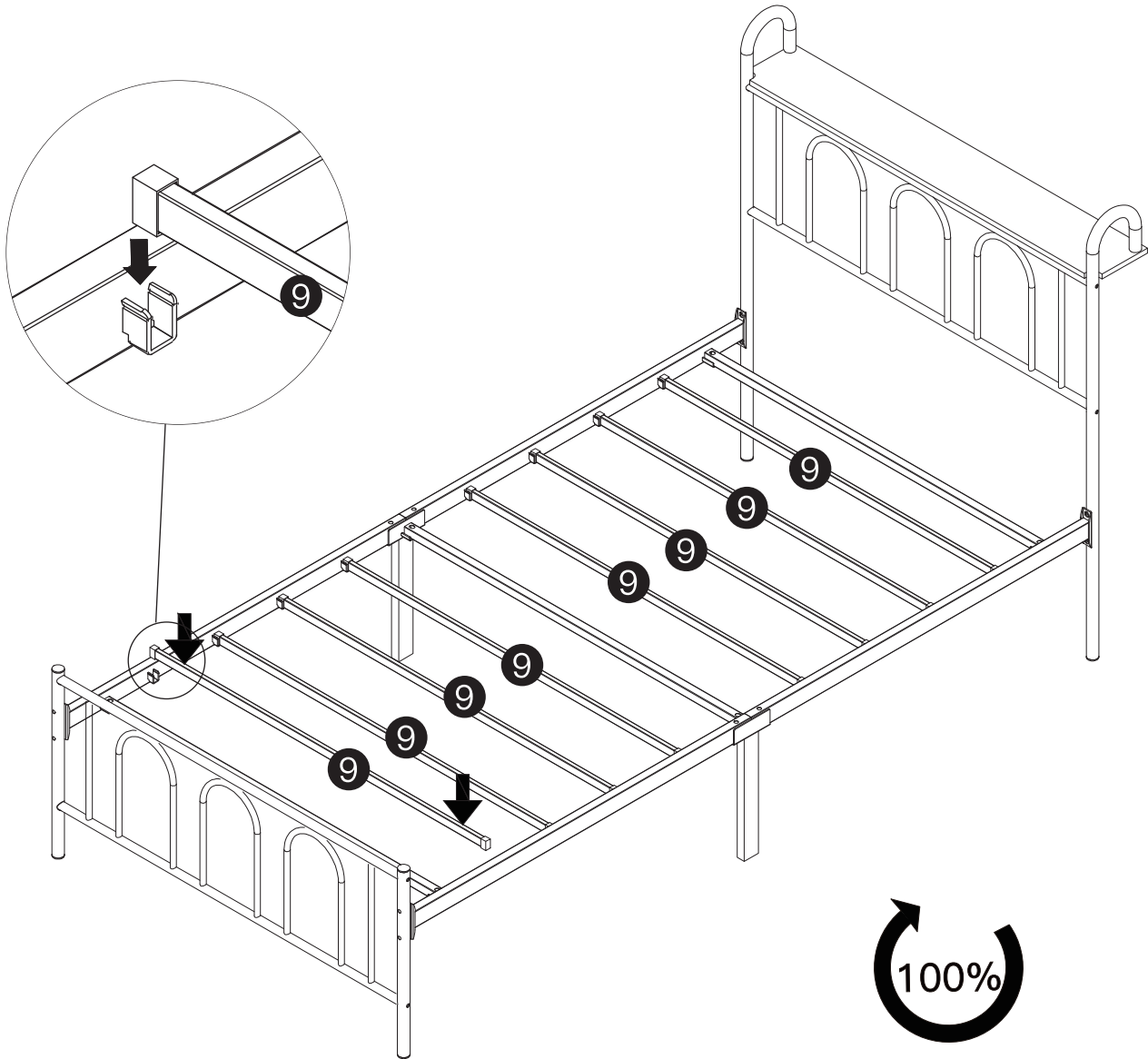
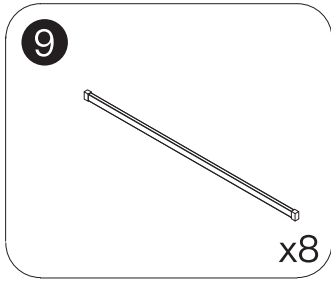

**NOTICE:**  
Please tighten all screws in  
the step.

# STEP 9

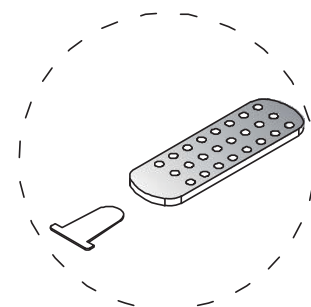
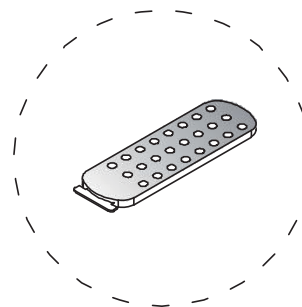
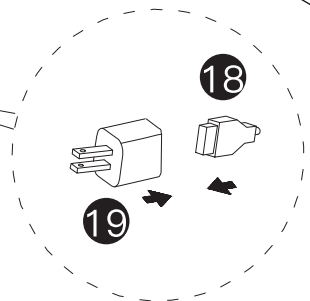
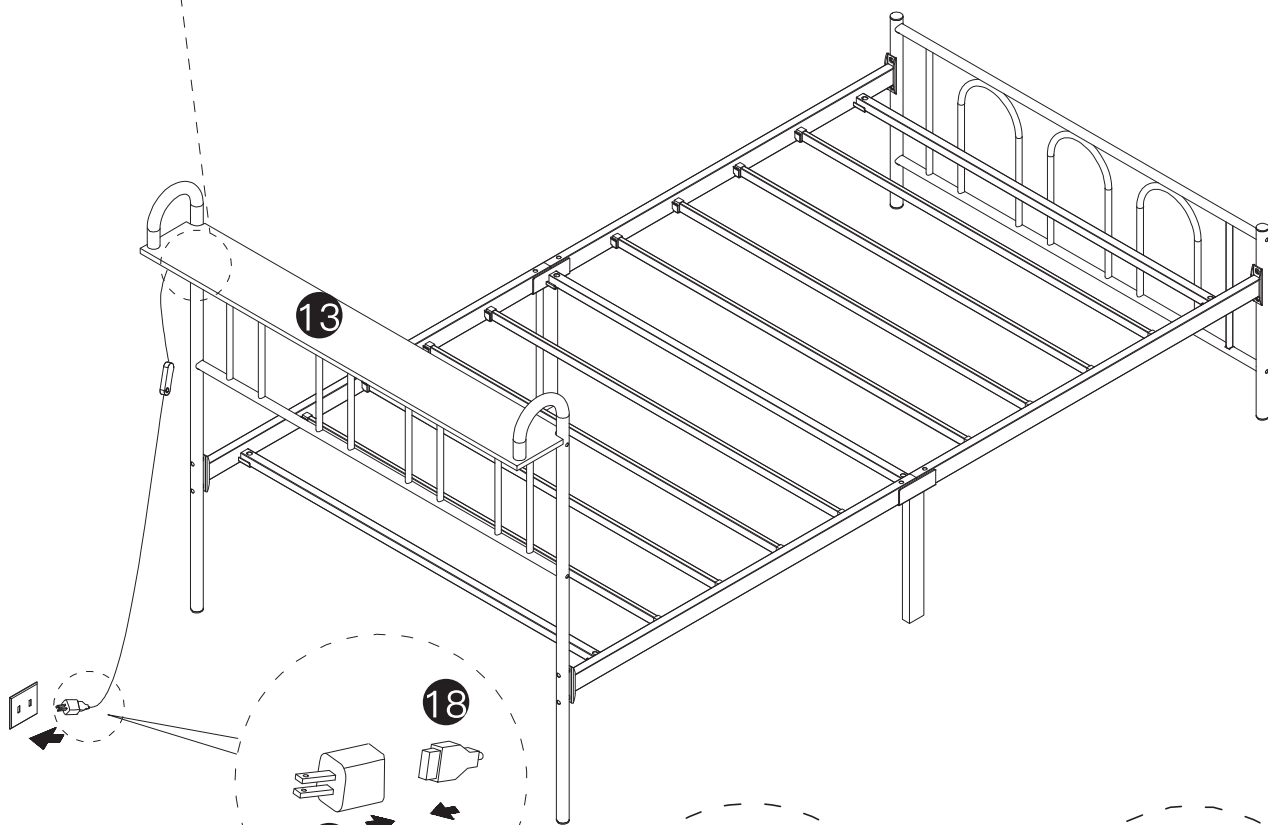
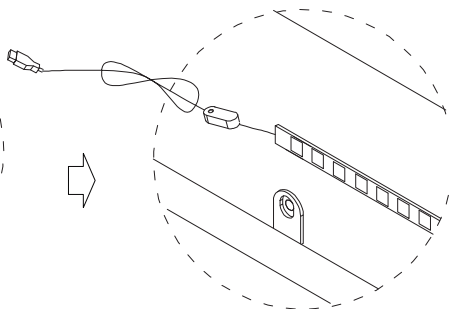
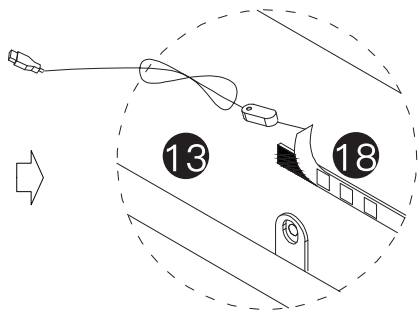
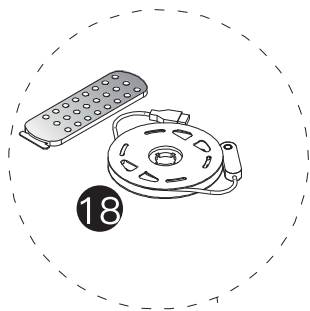
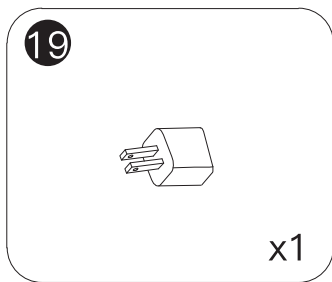
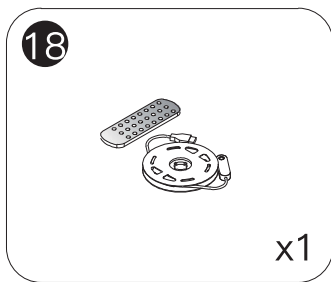

Extract the insulation sheet

## After-Sale Support

Dear Customer,

Thank you for choosing to purchase our products! We attach great importance to your shopping experience and hope to ensure that you are satisfied with this purchase.

Should you have any questions, please contact us through the original purchase platform. We will reply your messages as soon as possible, please kindly wait for the response from our team.

Thank you again for your understanding and support! If you have any other questions, please feel free to contact us at any time.

Best Regards,  
After sales service team