

LY & S Assembly Instructions

Power RAF reclining

IMPORTANT NOTE

Read these instructions carefully, and familiarize yourself with each procedure before assembling the furniture. Check that you have all the component parts, and familiarize yourself with each part before proceeding.

Take all the fittings out of the plastic bag and separate them into groups. Ensure you have enough space to lay out all the parts before assembly. To prevent damage to the parts, we recommend that you assemble the unit on a soft, level surface.

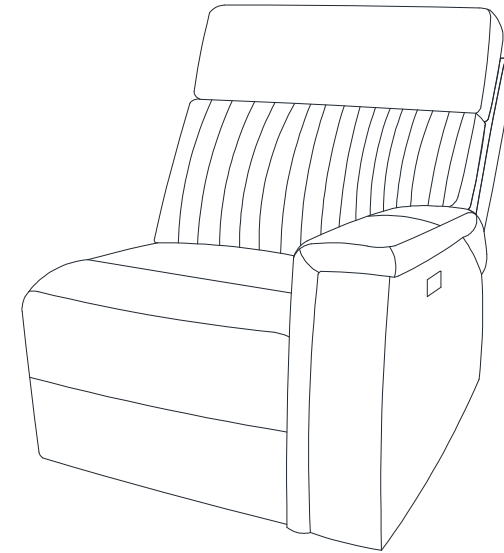

Part List

A. Back
1 piece

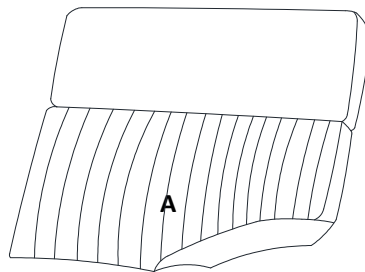

B. Seat x1; Transformer x1;Wingx1

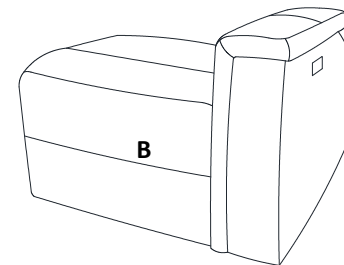

LY & S Assembly Instructions

Assembly Instructions

STEP 1

Detach the transformer and wing from the back of the Seat (B). (See Figure 1.)

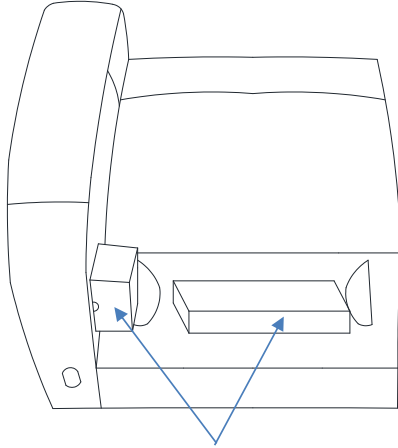

Figure 1

STEP 2

Attach the Back (A) to the Seat (B). Ensure the latches fit well. (See Figure 2.)

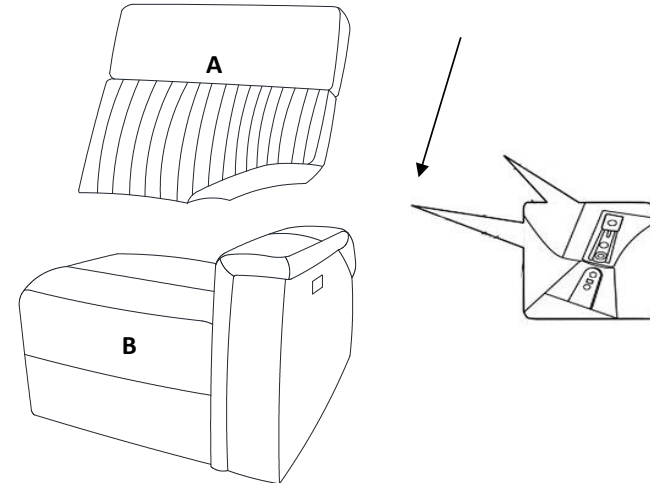

Figure 2

STEP 3

Connect the headrest cable to the power button control cable, and press it tightly (See Figure 3.)

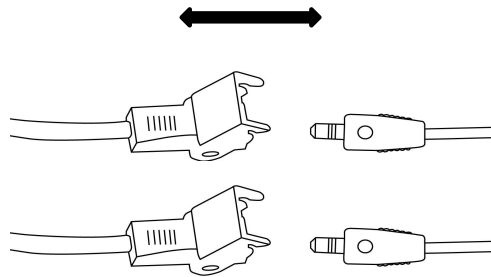

Figure 3

STEP 4

Attach the wing to the Back (A). Ensure the latches fit well (See Figure 4.)

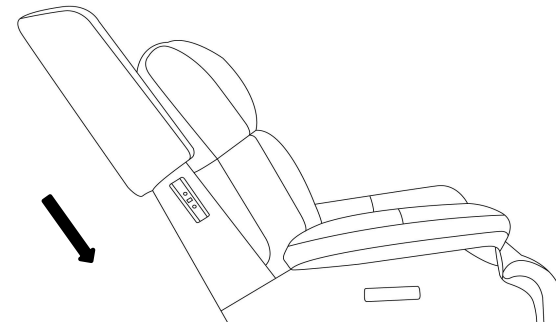

Figure 4

LY & S Assembly Instructions

STEP 5

Fasten the back flap to the bottom of the furniture. (See Figure 5.)

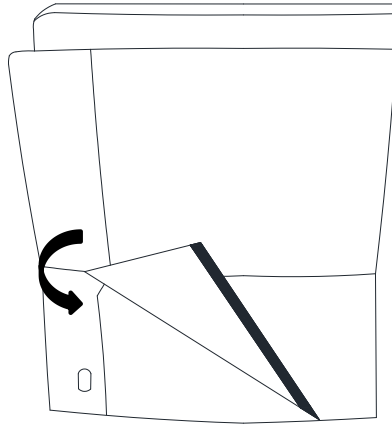

Figure 5

IMPORTANT NOTE

- To avoid any risk of suffocation to children or pets, dispose of all plastic bags immediately.
- To ensure proper performance, occasionally check for loose screws and tighten as needed.
- If the reclining functions are not working properly, check for loose cable connections before contacting the retailer.

LY & S Assembly Instructions

Power LAF reclining

IMPORTANT NOTE

Read these instructions carefully, and familiarize yourself with each procedure before assembling the furniture. Check that you have all the component parts, and familiarize yourself with each part before proceeding.

Take all the fittings out of the plastic bag and separate them into groups. Ensure you have enough space to lay out all the parts before assembly. To prevent damage to the parts, we recommend that you assemble the unit on a soft, level surface.

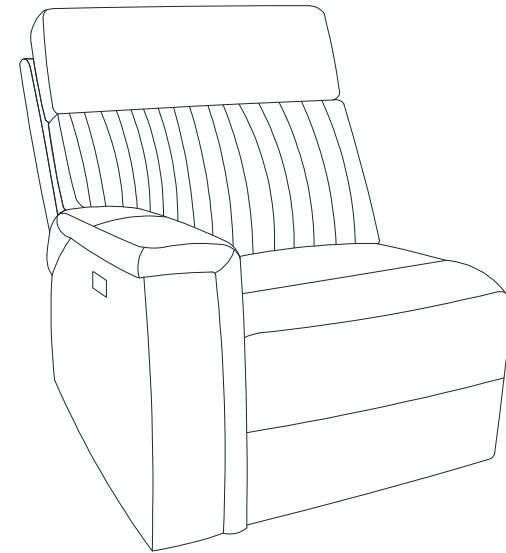

Part List

A. Back
1 piece

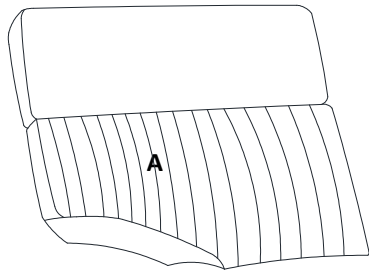

B. Seat x1; Transformer x1; Wingx1

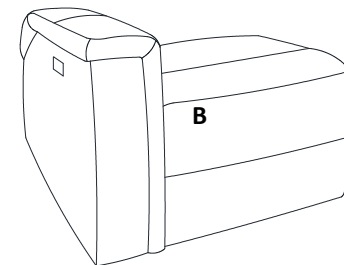

LY & S Assembly Instructions

Assembly Instructions

STEP 1

Detach the transformer and wing from the back of the Seat (B). (See Figure 1.)

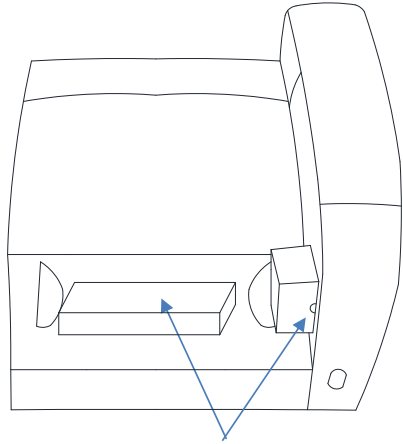

Figure 1

STEP 2

Attach the Back (A) to the Seat (B). Ensure the latches fit well. (See Figure 2.)

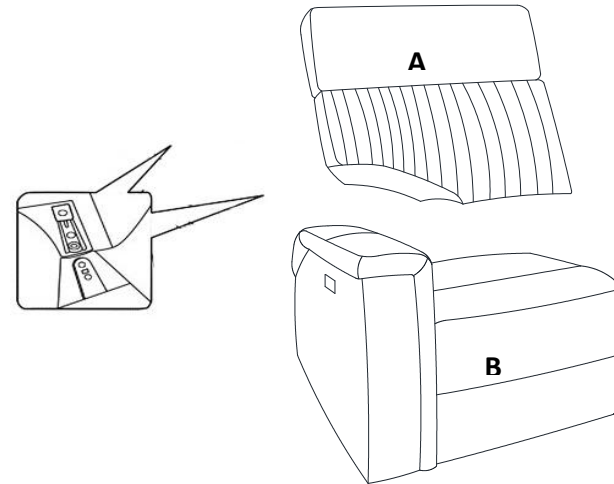

Figure 2

STEP 3

Connect the headrest cable to the power button control cable, and press it tightly (See Figure 3.)

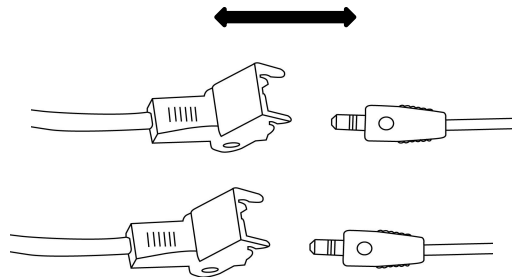

Figure 3

STEP 4

Attach the Wing to the Back (A). Ensure the latches fit well (See Figure 4.)

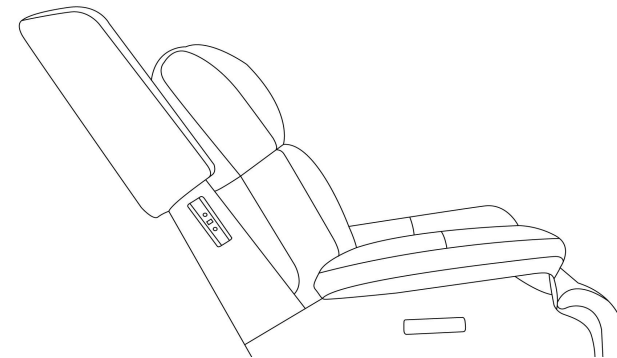

Figure 4

LY & S Assembly Instructions

STEP 5

Fasten the back flap to the bottom of the furniture. (See Figure 5.)

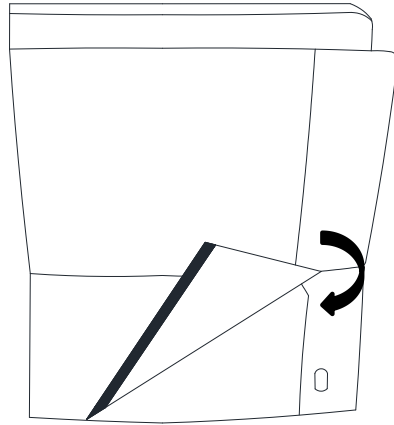

Figure 5

IMPORTANT NOTE

- To avoid any risk of suffocation to children or pets, dispose of all plastic bags immediately.
- To ensure proper performance, occasionally check for loose screws and tighten as needed.
- If the reclining functions are not working properly, check for loose cable connections before contacting the retailer.

LY & S Assembly Instructions

Console

IMPORTANT NOTE

Read these instructions carefully, and familiarize yourself with each procedure before assembling the furniture. Check that you have all the component parts, and familiarize yourself with each part before proceeding.

Take all the fittings out of the plastic bag and separate them into groups. Ensure you have enough space to lay out all the parts before assembly. To prevent damage to the parts, we recommend that you assemble the unit on a soft, level surface.

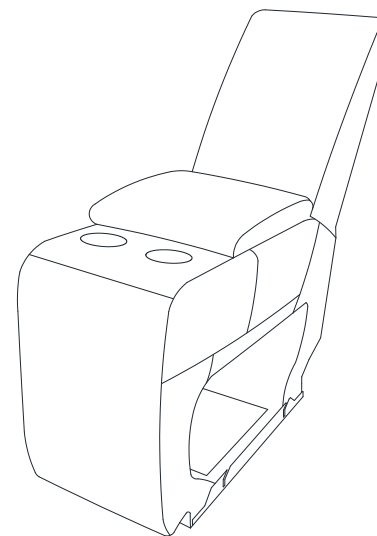

Part List

A. Back
1 piece

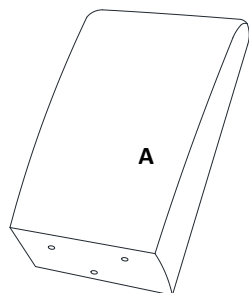

B. Base x1

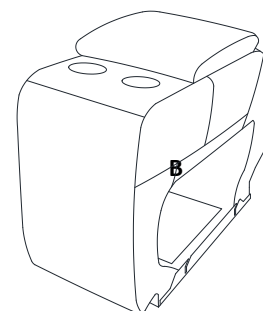

LY & S Assembly Instructions

Assembly Instructions

STEP 1

Open the storage from the top Base(B) and get the bolts

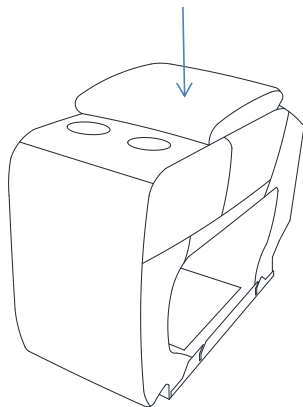

Figure 1

STEP 2

Align the holes on the Back(A) and Base(B), tighten with bolts. (See Figure 2.)

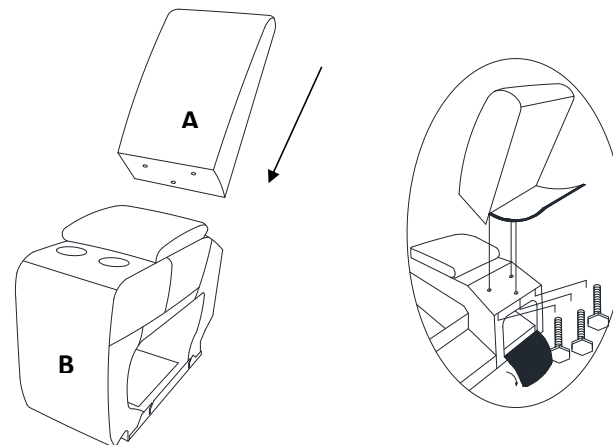

Figure 2

STEP 2

Fasten the back flap to the bottom of the furniture. (See Figure 2.)

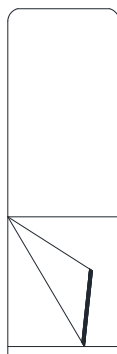

Figure 3

IMPORTANT NOTE

- To avoid any risk of suffocation to children or pets, dispose of all plastic bags immediately.
- To ensure proper performance, occasionally check for loose screws and tighten as needed.
- If the reclining functions are not working properly, check for loose cable connections before contacting the retailer.

LY & S Assembly Instructions

Connecting the parts to loveseat with console

IMPORTANT NOTE

Read these instructions carefully, and familiarize yourself with each procedure before assembling the furniture. Check that you have all the component parts, and familiarize yourself with each part before proceeding.

Motion to Stationary

Motion With Female bar

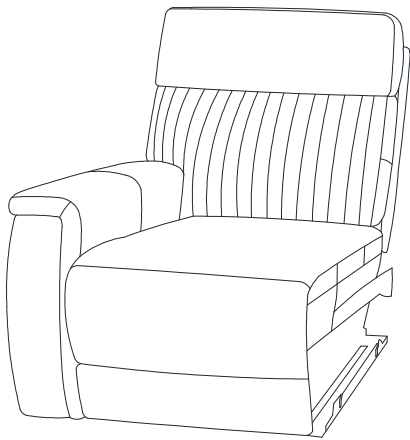

Stationary With Male bar

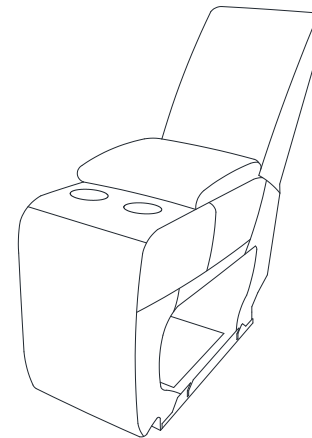

Attach the Male bar to the Female bar. Ensure the latches fit well.

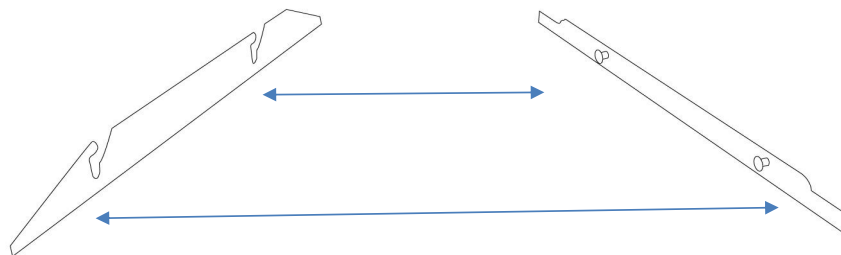

LY & S Assembly Instructions

Stationary to Motion

Stationary With Female bar

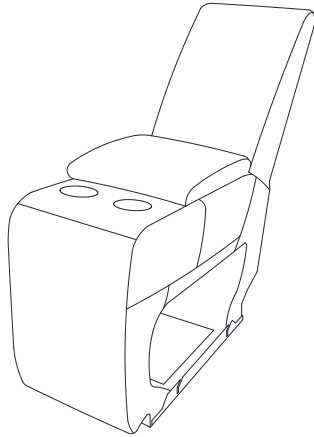

Motion With Male bar

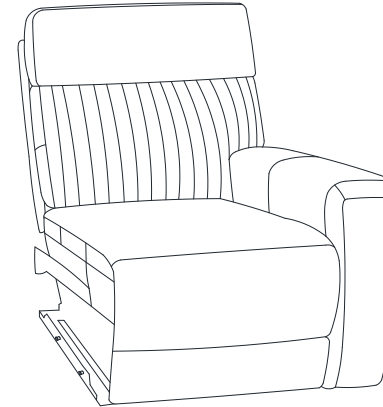

Attach the Male bar to the Female bar. Ensure the latches fit well.

Finish

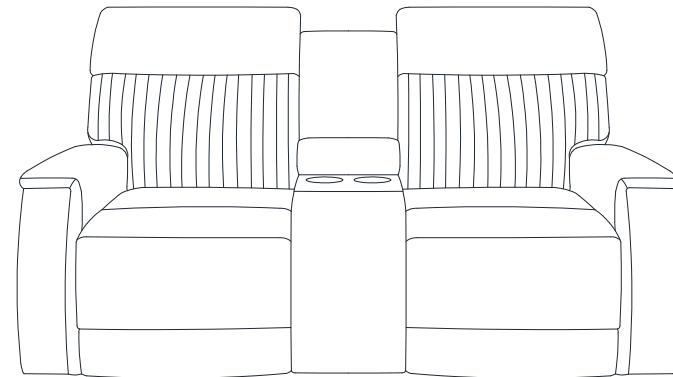
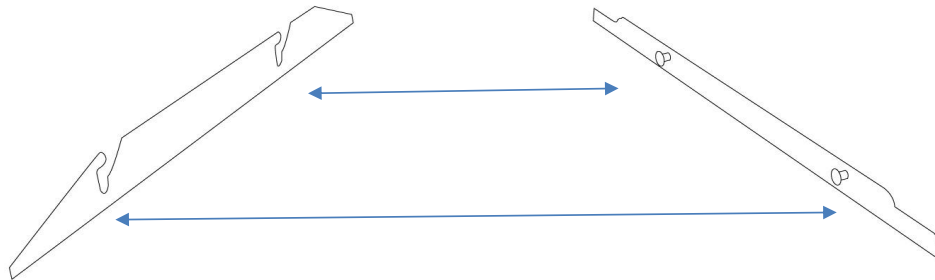

IMPORTANT NOTE

- To avoid any risk of suffocation to children or pets, dispose of all plastic bags immediately.
- To ensure proper performance, occasionally check for loose screws and tighten as needed.
- If the reclining functions are not working properly, check for loose cable connections before contacting the retailer.