

# WARNING

- \* Switch off the main electrical supply from the main fuse box / circuit breaker before installation.
- \* Inspect item carefully before attempting to install.
- \* If there is any damages or obvious defects, do not install.
- \* Item may not be returned once it has been installed.











# CARE AND MAINTENANCE

- \* To clean the outside of the fixture, use a dry or slightly dampened clean cloth (use clean water, never a solvent) to wipe the surface of the fixture.
- \* To clean the inside of the fixture, first disconnect power to the fixture by turning off the circuit breaker or by removing the fuse at the fuse box. Next, use a dry or slightly dampened clean cloth (use clean water, never a solvent) to wipe the interior surface of the fixture.
- \* Do not use any cleaners with chemical, solvents or harsh abrasives. Use only a dry soft cloth to dust or wipe carefully.

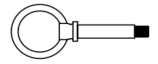
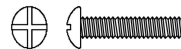
# NOTICE& IMPORTANT SAFETY INSTRUCTIONS

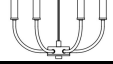
- \*\* WE RECOMMEND INSTALLATION OF THIS LIGHTING FIXTURE BE DONE BY A LICENSED ELECTRICIAN \*\*
- \* Please make sure that you have all parts indicated before you begin assembly of this item
- \* This item should be assembled on a soft surface to prevent scratching the finish during assembly
- \* To reduce the risk of fire, electrical shock or injury to persons or property, please follow the guideline below for safe use and installation
- \*The external flexible cable or cord of this lamp cannot be replaced  
If the cord is damaged, the lamp shall be destroyed

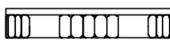
## Part List and Hardware List

PIECE	DESCRIPTION	PICTURE	QUANTITY	PIECE	DESCRIPTION	PICTURE	QUANTITY
A	Wire Nut		3X	H	Closable link/cap		2X
B	Mounting Plate		1X	I	Chain		1X
C	Ground Screw		1X	J	Loop Assembly		1X
D	Mounting Screw		2X	K	Frame		1X
E	Canopy		1X	L	Lamp Bobby		1X
F	Hanging Loop		1X	M	Tube		1X
G	Canopy Nut		1X	N	Bulb		6X

7"L X 15"W X 35.5-

94.5"H

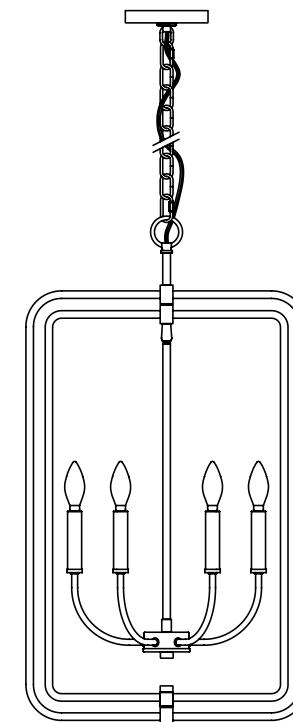

## PREPARATION

- \* Before beginning assembly of product, make sure all parts are present. Compare parts with package contents list and hardware contents list.
- \* If any part is missing or damaged, do not attempt to assemble the product.
- \* Estimated Assembly Time: 15 minutes.
- \* Tools Required for Assembly (not included): Screwdriver, Junction box
- \* If you are having difficulty, our friendly Customer Care team is always here to help. Please email [customersupport@safavieh.com](mailto:customersupport@safavieh.com)

**NOTE: PLEASE USE TYPE "B" BULB MAX 40-WATT OR LED BULB MAX 5-WATT, THERE ARE 4-WATT LED BULB IN THE BOX**

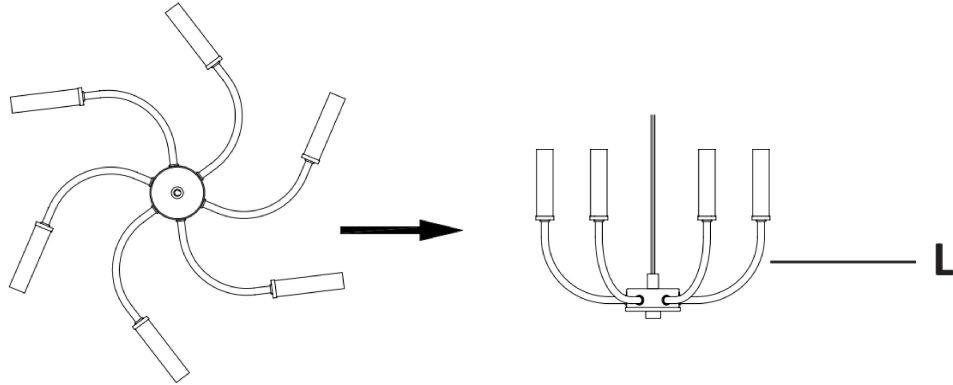

**Step 1:** Adjust the angle of the spider of the Lamp Body (L).

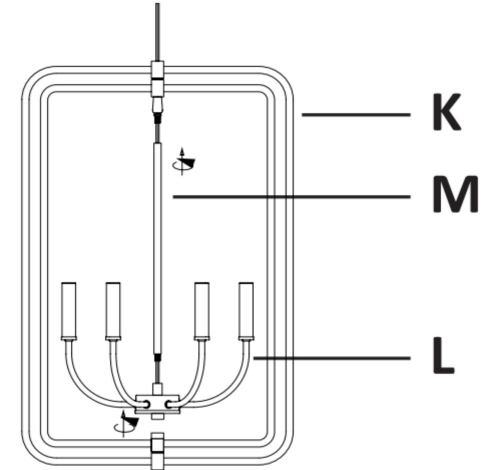

**Step 2:** Guide the fixture wire with the bare copper ground wire through the Tubes (M) and the Frame (K). Rotate the Tube (M) and Fixture body (L) clockwise till tight.

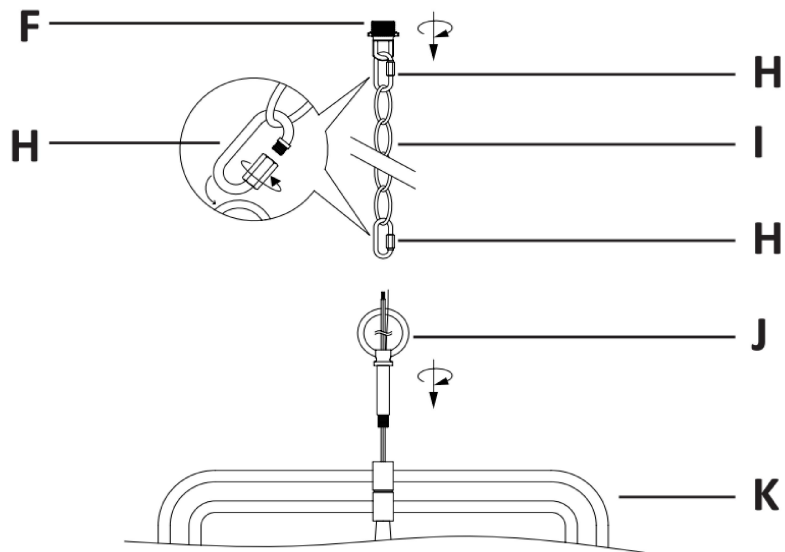

**Step 3:** Tighten the Loop Assembly (J) onto the top of the Frame (K).  
Screw the Chain(I) to the Hanging Loop(F) and the Loop of the Loop Assembly (J) with Closable link/cap(H) as diagram.

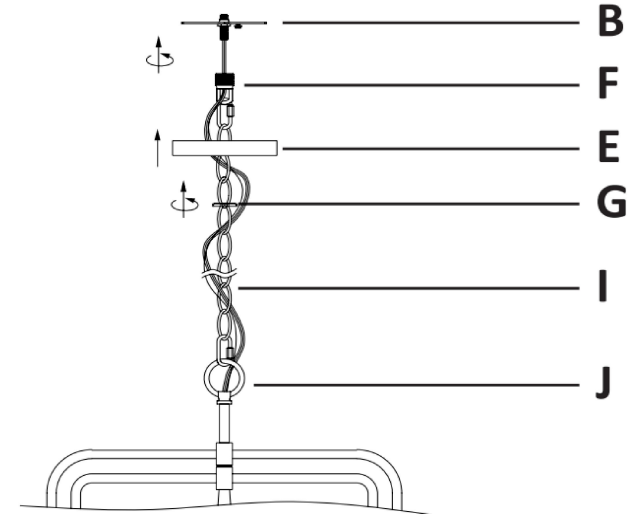

**Step 4:** Weave the 2 wire power cord and bare ground wire through every other loop to the chain(I), center holes of Hanging Loop(F), Canopy(E) & Mounting Plate(B) as diagram.  
Slide the Canopy Nut(G) then the Canopy(E) to the end of the Chain(I).

## PREPARATION

- \* Before beginning assembly of product, make sure all parts are present. Compare parts with package contents list and hardware contents list.
- \* If any part is missing or damaged, do not attempt to assemble the product.
- \* Estimated Assembly Time: 15 minutes.
- \* Tools Required for Assembly (not included): Screwdriver, Junction box
- \* If you are having difficulty, our friendly Customer Care team is always here to help.

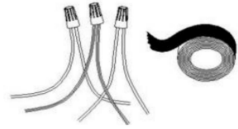
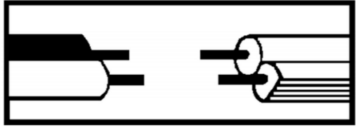

### Step 5: Wire connection.

Connect fixture neutral wire (ribbed) to the outlet box neutral wire (usually white) using a wire nut.

Connect fixture hot wire (smooth with markings) to the outlet box hot wire (usually black) using a wire nut.

CAUTION: Do not reverse the hot and neutral connections.

Grounding Instructions:

Wrap ground wire from outlet box around ground screw on mounting plate, no less than 2" from wire end. Tighten ground screw. If fixture is supplied with a ground wire, connect to outlet ground wire with a wire nut.

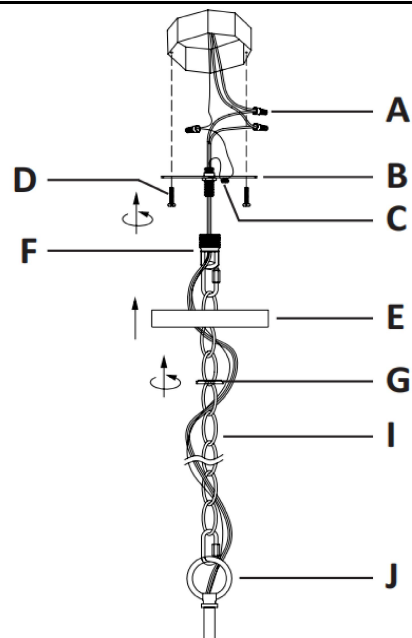

- Step 6:** Attach the Mounting Plate (B) onto the junction box with two Mounting Screws (D). Slide the Canopy (E) upward along the chain(J) till the ceiling surface. Fix it by rotating the Canopy Nut(G) clockwise to engage it with the threaded portion of the Hanging Loop (F) until secure. Do not over tighten this nut.

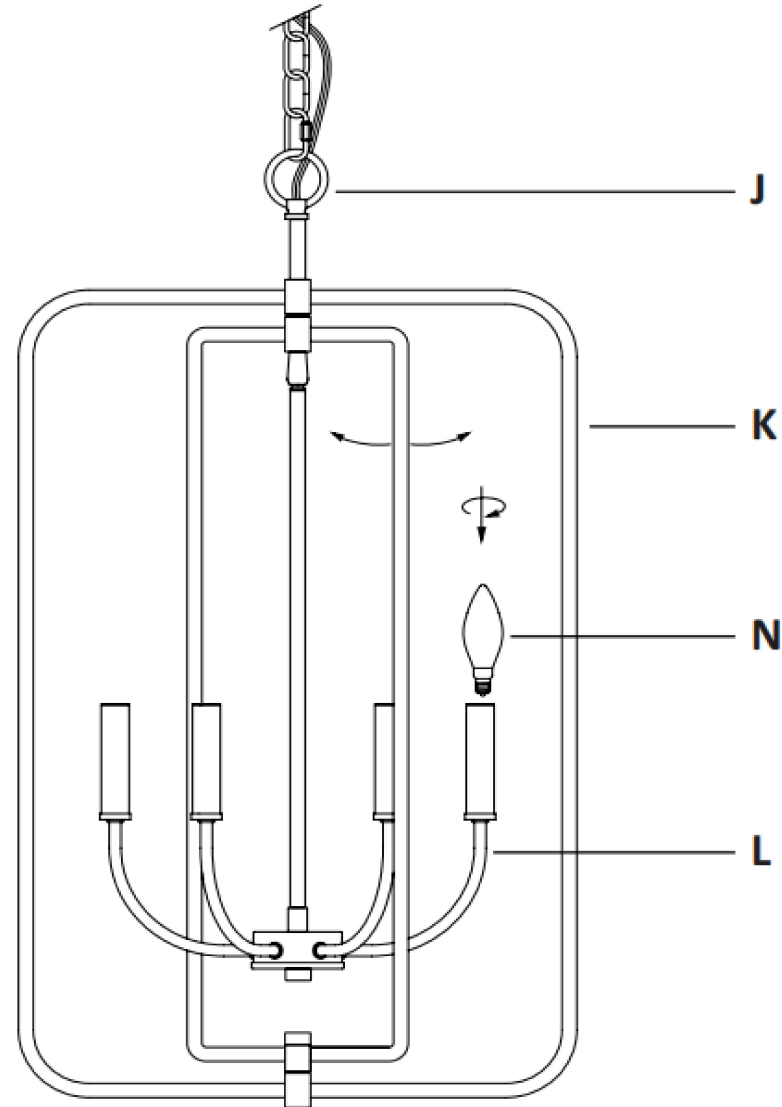

- Step 7:** Insert the bulbs(N) into the sockets until secure.