

Let's build the

Benji Bookcase

SKU 66807

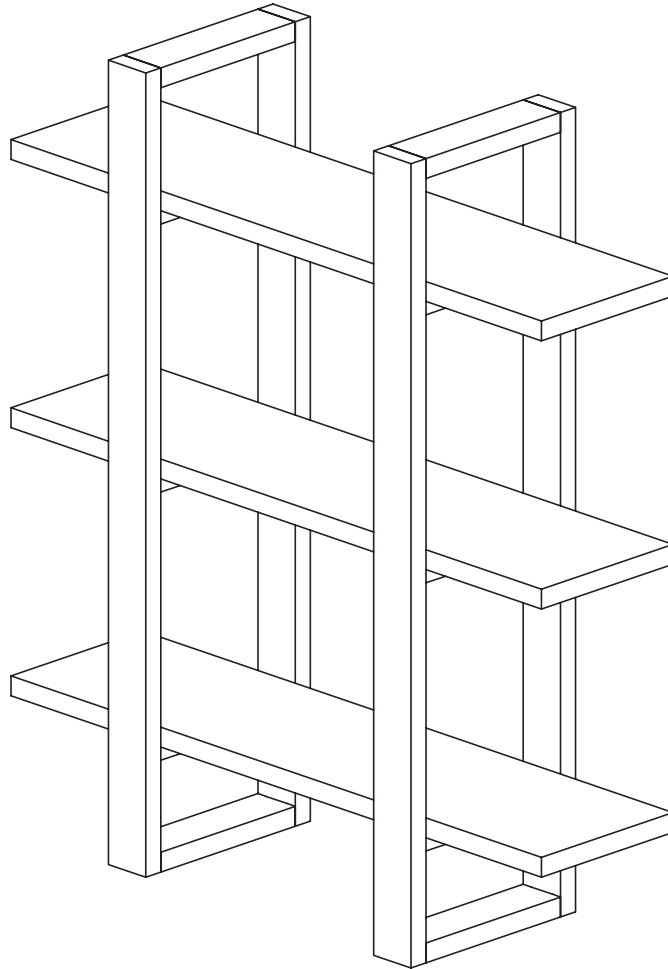

Scan me!

Inspiration
Digital Instructions
Free Lifetime Warranty

nathan james

22-1107

Ok, let's get rolling

This should be easy, just follow our instructions and you will be back to Netflix in no time.

Estimated time for assembly



35:00

What you need

- Some of your favourite bubbly or your preferred relaxant
- Use the packaging carton as a working surface to prevent product damage during assembly
- $\frac{5}{16}$ " Drill bit
- Phillips head screwdriver

Weight Limitation



120
lbs

Toll-free at 1-866-619-1004
Help@nathanjames.com
Nathanjames.com/help

What's included

Description	Qty
A Vertical Support Frame	1
B Shelf	3
1 $\frac{1}{4}$ x $1\frac{1}{8}$ " Hex Button Head Bolt	12
2 Washer	12
3 Allen Key	1
4 M4*50mm Screw	3
5 Non-Drywall Wall Anchor	3
6 Drywall Wall Anchor	3
7 Metal Bracket	1
8 M4*15mm Screw	1
9 Footpads	4

Scan me!

Inspiration
Digital Instructions
Free Lifetime Warranty



The goods

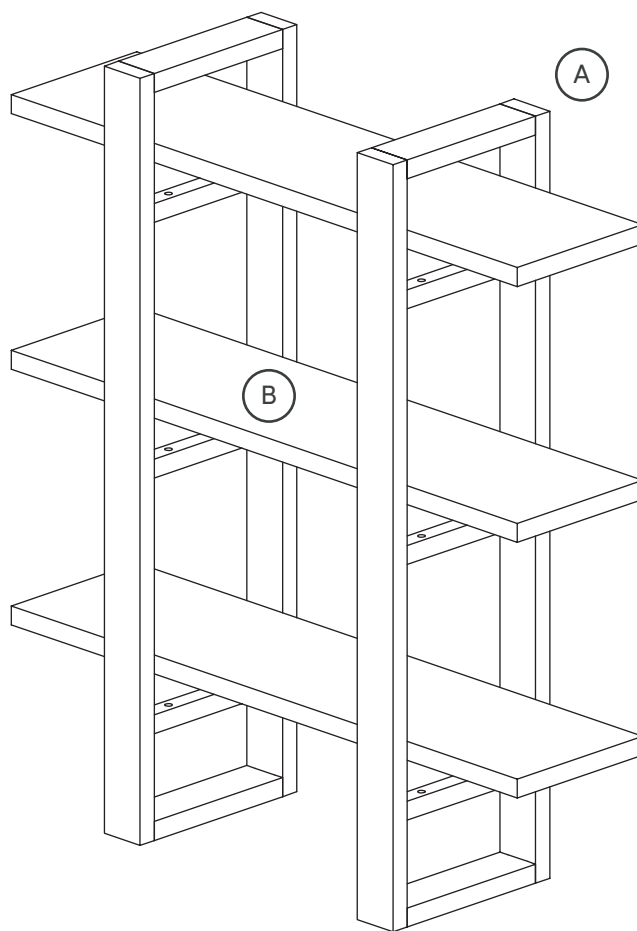

1

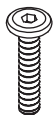

2



3

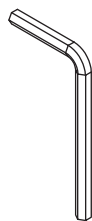

4



5



6



7

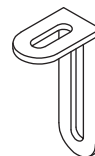

8



9



IMPORTANT

1. Do not tighten bolts / screws completely until all bolts / screws are lined up and inserted into holes.
2. Do not over tighten screws and bolts to avoid stripping.
3. Please use hand tools to assemble this product. Do not use power tools.



Step 1

It's as easy as it looks! Insert Shelves (B) into Frames (A) as shown. Secure using 1/4 x 1 1/8" Hex Button Head Bolts (1) and Washers (2). Tighten using provided Allen Key (4).

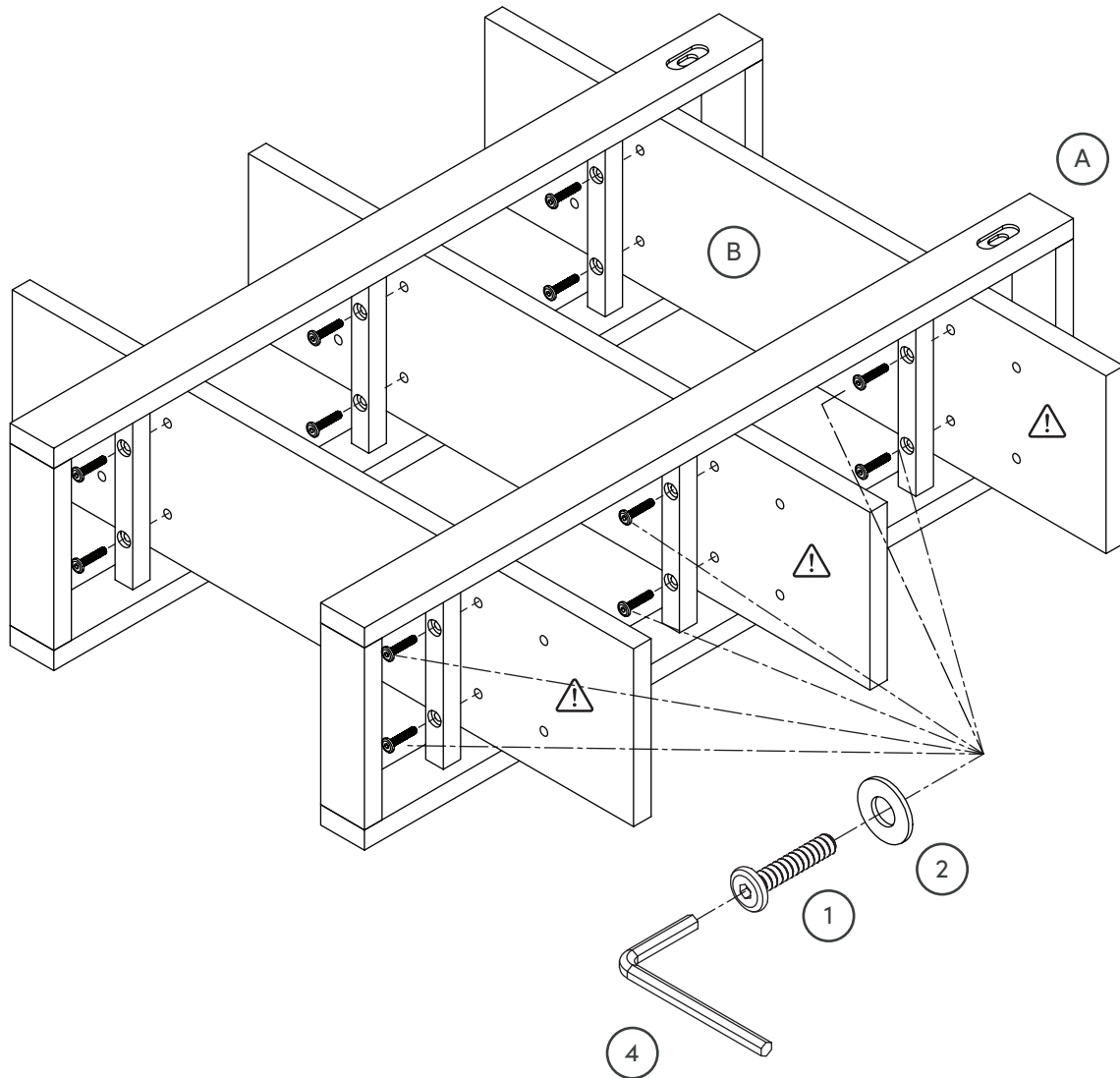

Important Note:

You will notice multiple sets of holes on the underside of each Shelf.

We have provided you the option to choose the spacing between the Vertical Support Frames.

Do NOT overtighten hardware.
Tighten only 75% for now.

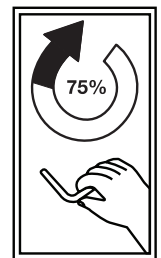

Step 2

Attach Metal Bracket (7) to bottom of Shelf (B) using the M4*15mm Screws (8) using screwdriver as shown. If placing the shelf on the floor remove paper backing from the Footpads (9) and adhere to bottom of the Vertical Support Frames (A).

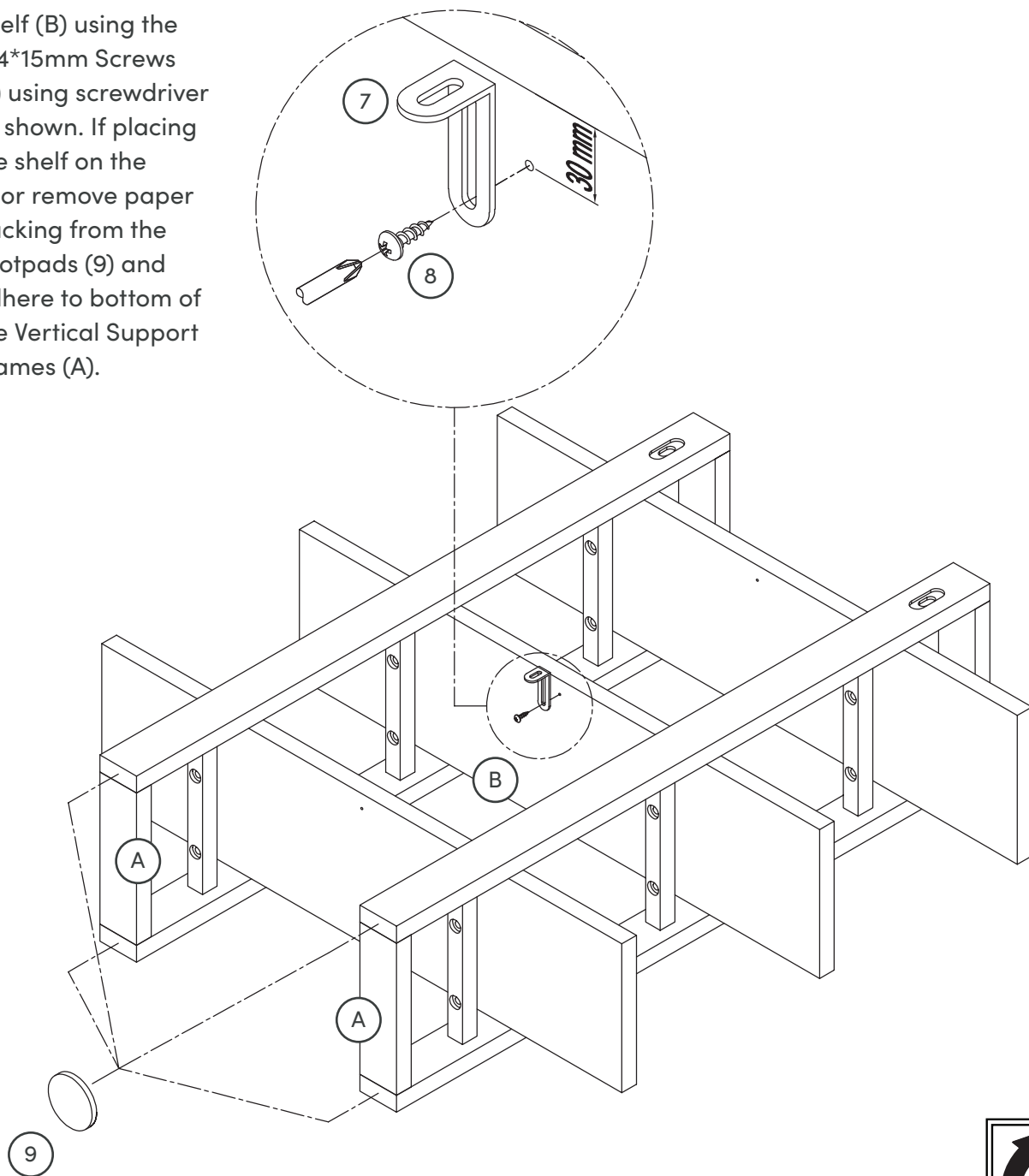

Note: Only apply Footpads (9) on the bottom of the shelf if you plan to have this shelf sit on the floor.

Do NOT overtighten hardware.
Tighten only 75% for now.

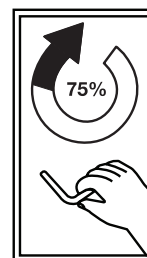

Step 3

Stand the shelf upright on a flat, level surface. Tighten Bolts (1) until they are securely fastened.

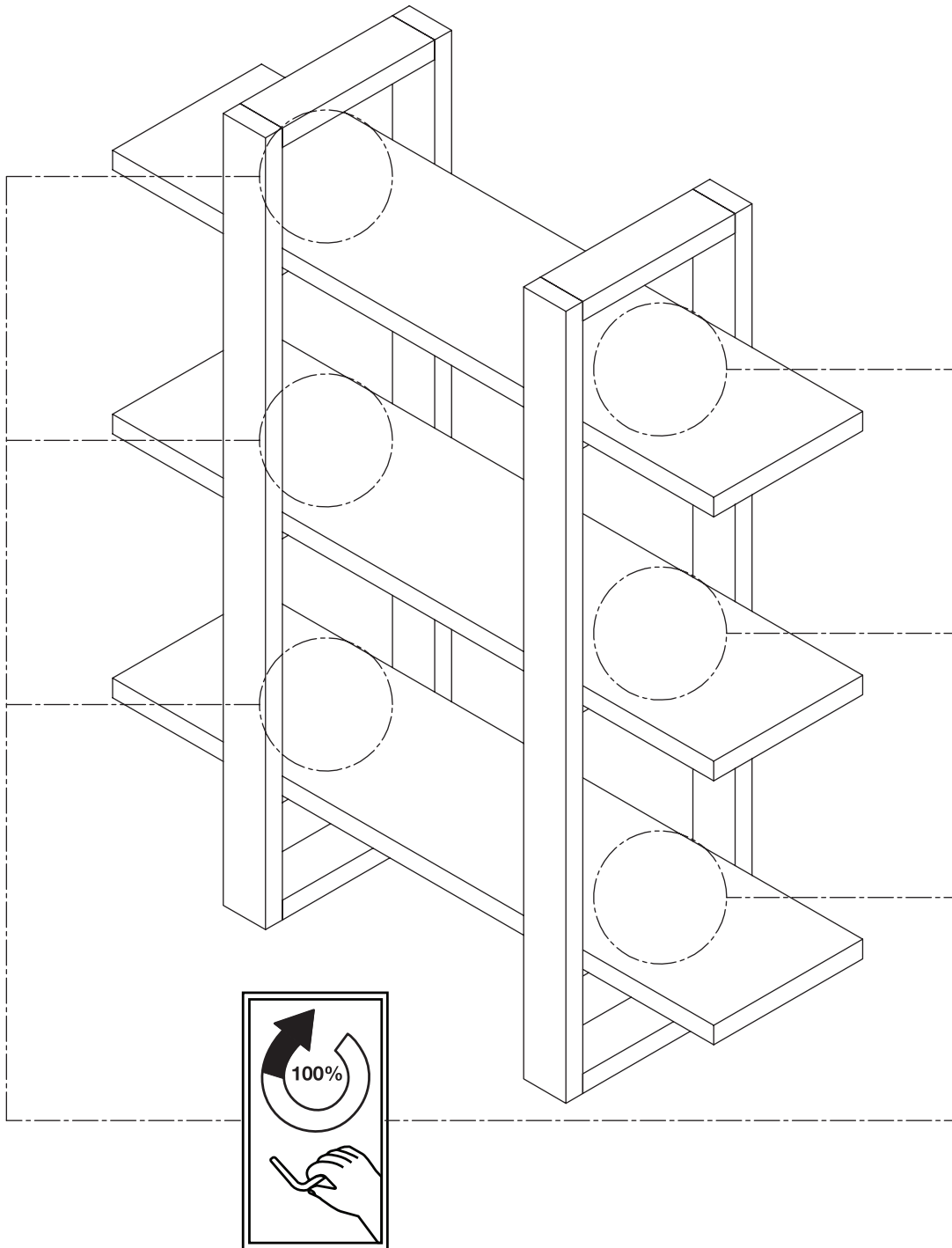

Step 4—Option 1: Floor Mounting

You're almost done! Time to mount the shelf. Follow the instructions from this page if mounting on the floor. Skip ahead to page 9 if mounting on the wall.

Set assembled product in its desired location against the wall. Adjust the back of the Metal Bracket (7) so it touches the wall, then fully tighten M4*15mm Screw (8) into the bottom of the Shelf (B).

Next, using the back of the Metal Bracket (7) against the wall, mark where to drill the hole for the wall anchor that you will use to tether the shelf to the wall. Using a 5/16" drill bit, drill a hole on your mark, then push the Wall Anchor (5)(6) for the proper wall type into the hole.

Finally, fasten M4*50mm Screw (4) through the Metal Bracket (7) into the Wall Anchor (5)(6).

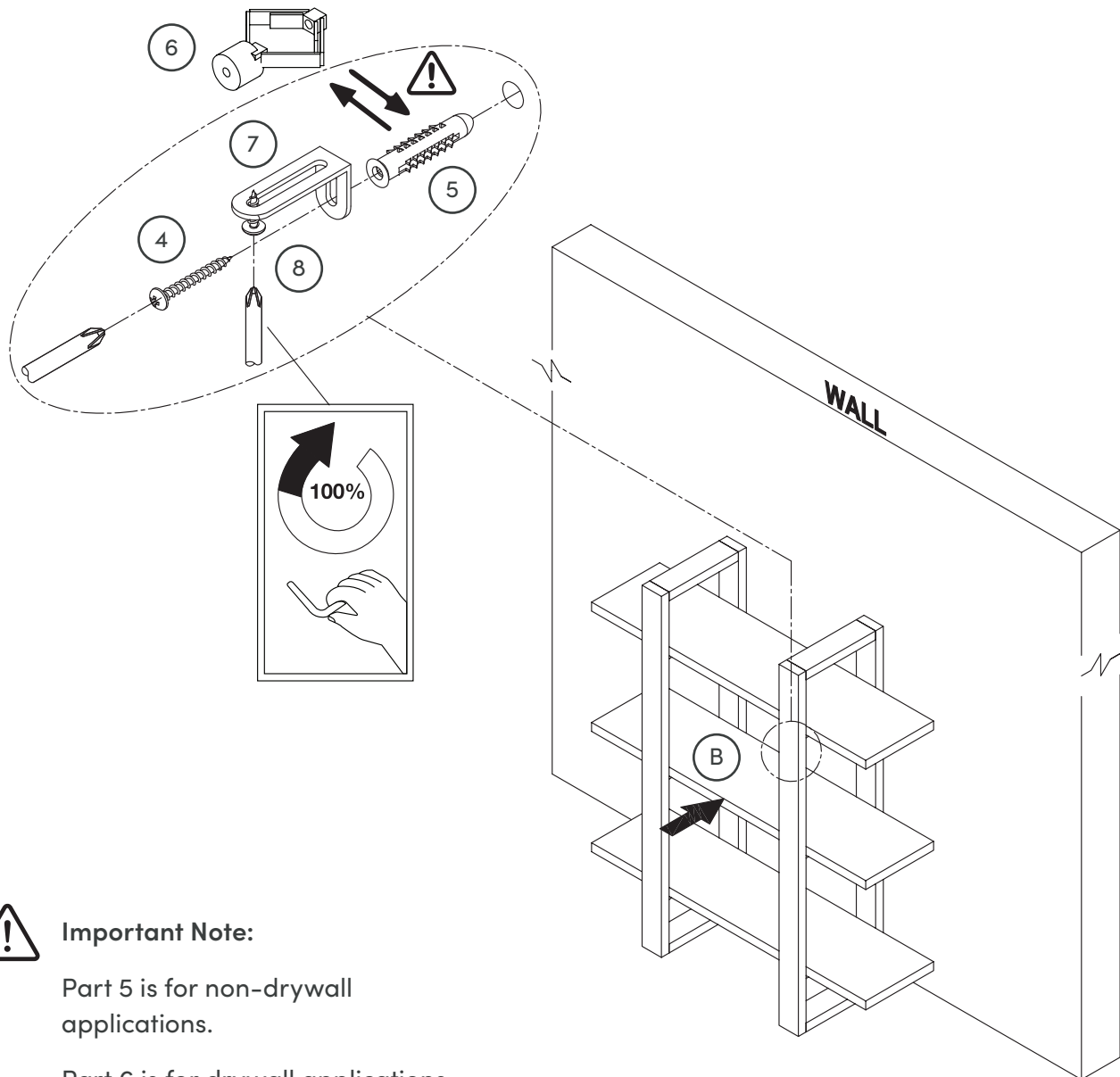

Important Note:

Part 5 is for non-drywall applications.

Part 6 is for drywall applications.



How to Use Drywall Anchors

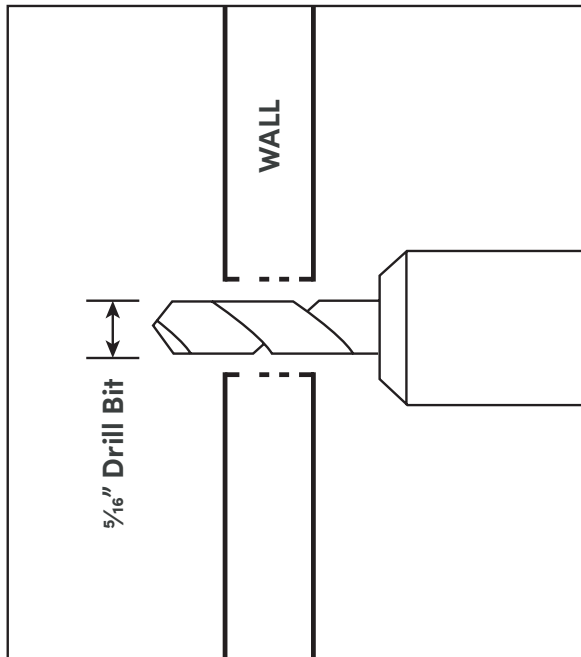

1. Drill hole with 5/16" bit.

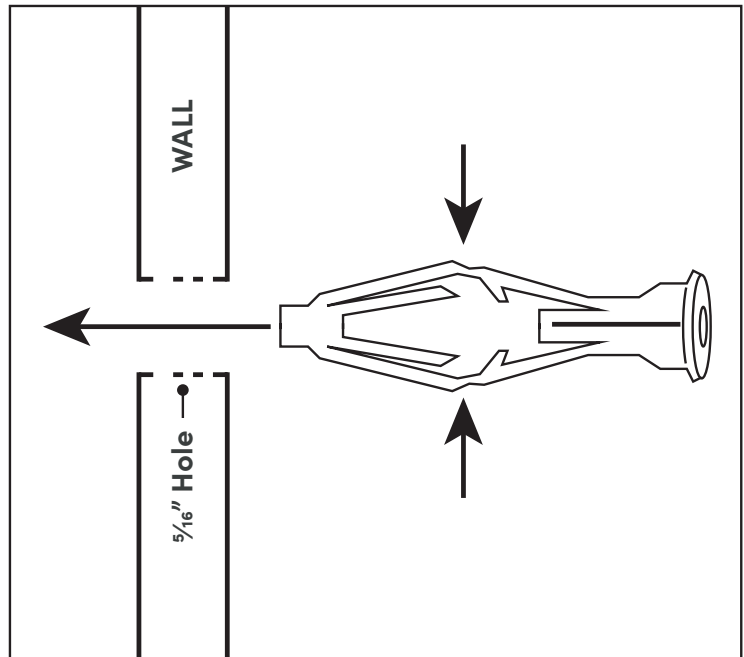

2. Pinch and insert.

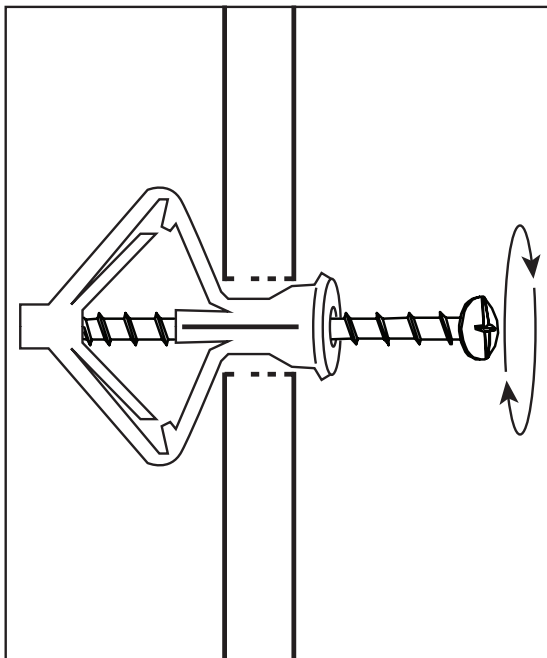

3. Begin tightening.

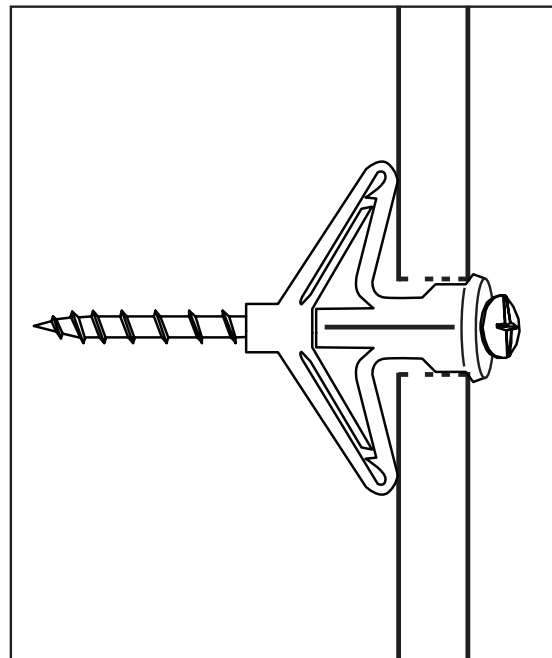

4. Anchor is secure when screw is tightened to 100%.



Step 4—Option 2: Wall Mounting

Choose your desired shelf location on the wall. Using the Wall Anchor Spacing Dimensions graphic below, begin to line up & mark where you will need to drill holes for the Wall Anchors (5)(6).

Using a 5/16" drill bit, drill holes on your marks then push the Wall Anchors (5)(6), for the proper wall type, into the holes.

Finally, fasten a M4*50mm Screw (4) into each of the top holes, while leaving a small gap between the back of the screw and wall to allow for the unit to hang on. (Do NOT fasten a screw into the bottom hole yet).

Wall Anchor Spacing Dimensions

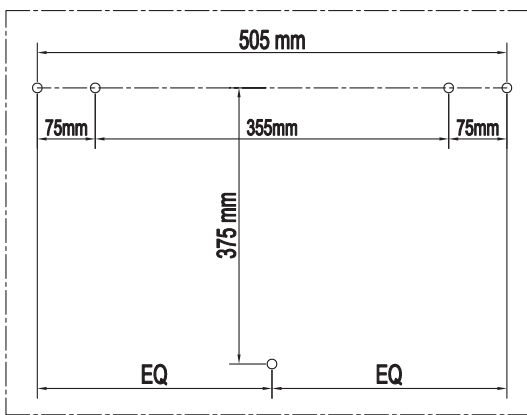

Important Note:

Remember your options from Step 1? The graphic above shows the hole spacing dimensions for both Vertical Support Frame (A) spacing options.

For this step, you will only need to drill 3 holes respective to which set of holes you chose earlier when completing Step 1.



Important Note:

Part 5 is for non-drywall applications.

Part 6 is for drywall applications.

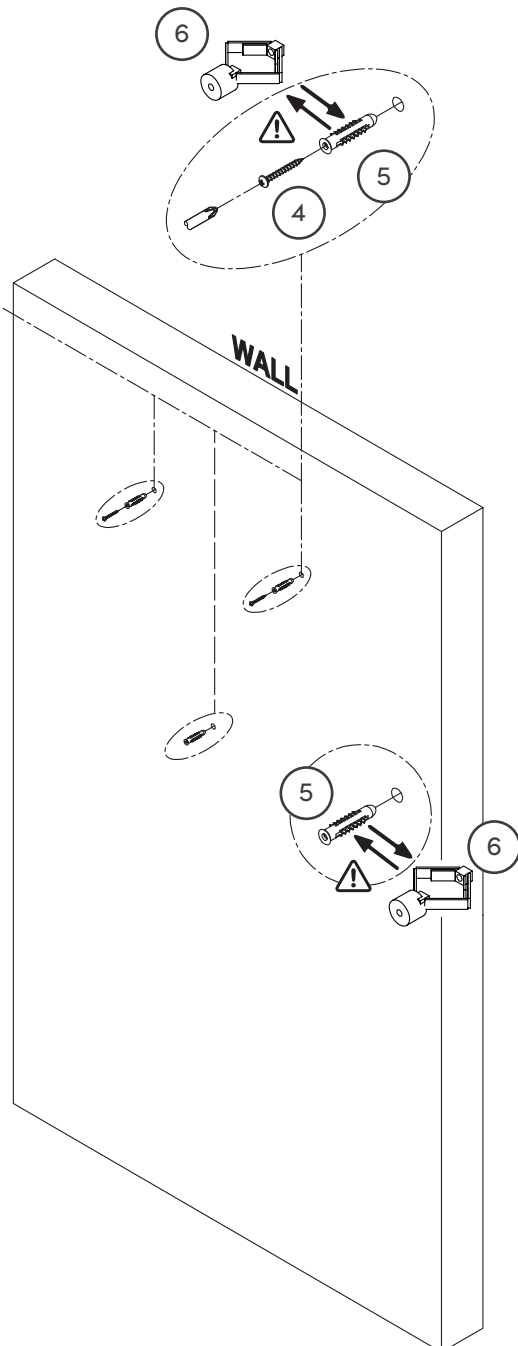

Step 5—Option 2: Wall Mounting

Finally, lift your assembled bookcase to the wall and align the top keyhole brackets on the back of the Vertical Support Frames (A) with the top screws in the Wall Anchors (5)(6) on the wall.

Slowly lower the bookcase onto the top screws, making sure the bookcase is properly mounted on the screws before letting it rest on its own.

Once it is hanging in place, secure the Metal Bracket (7) to the wall by first adjusting the back of the Metal Bracket (7) so that it touches the wall. Once it's touching the wall, tighten the M4*15mm Screw (8) to 100%. Finally, fasten the M4*50mm Screw (4) through the Metal Bracket (7) and into the Wall Anchor (5)(6).

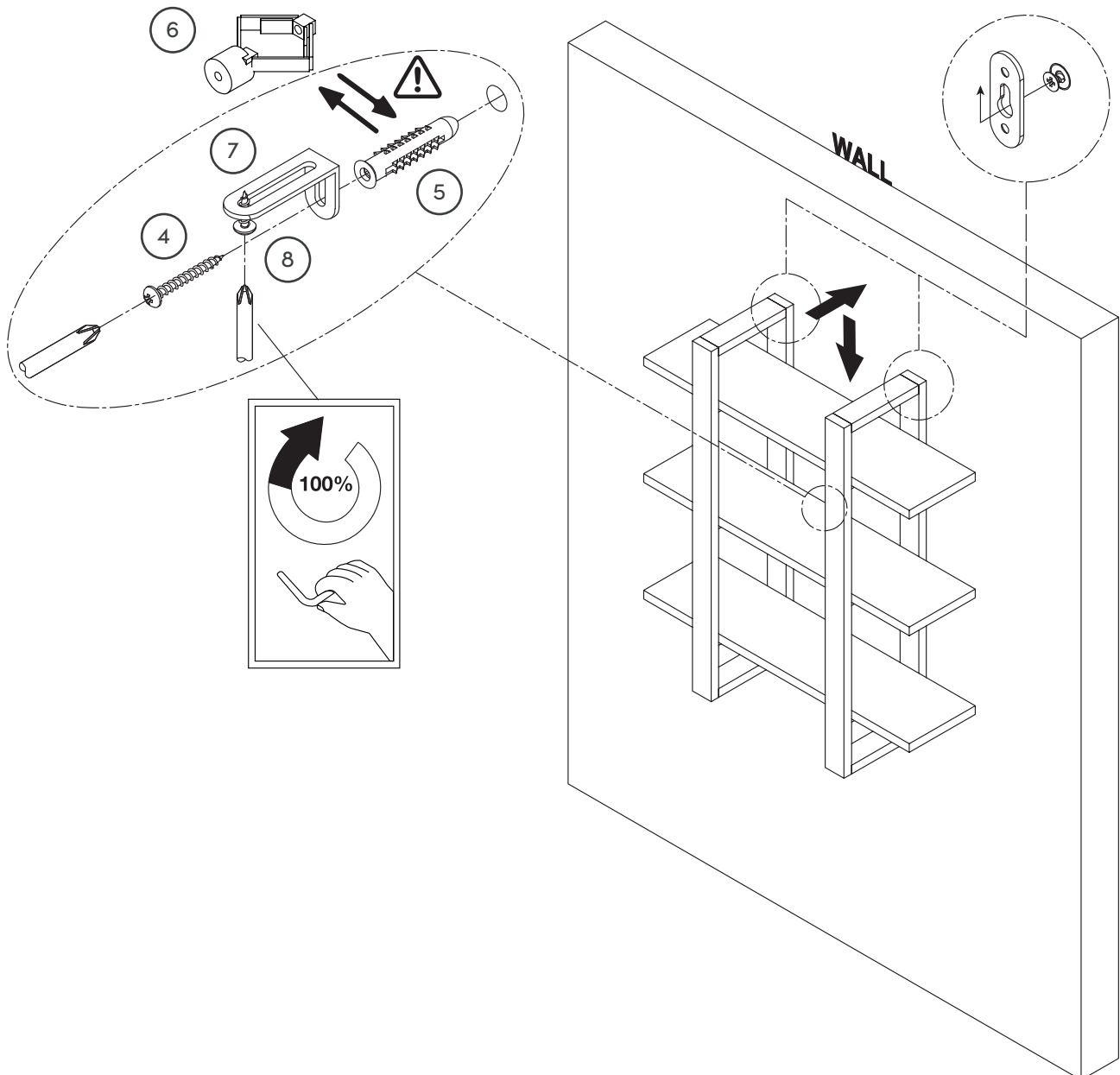

No heartburn, when we handle the return

Give us a call **1-866-619-1004** or shoot us a message at **help@nathanjames.com** we will issue you a free replacement with **zero hassle**.

Our way



Give us a call



Replacement



You

Their way



Re-package item



Schedule pick up



Track package



Replacement



You

We really don't want you to go through the hassle of re-packaging your item and sending it back, because let's be honest...nobody has time for that.



Safety first, fun later

We want your Benji Bookcase to last as long as possible, so we recommend that you tighten the screws 2 weeks after assembly and for added safety check the tightness of all screws every 2 months.

For proper care and treatment, please check our website at NathanJames.com/products

Safe use of this product starts with you.

Use this Benji Bookcase responsibly with the primary concern for your safety. Follow assembly instructions carefully and inspect product upon receipt and each use.

Nathan James and its parent companies cannot be held legally responsible for any injuries or death resulted from failure to follow instructions or improper use of this product.

Do not modify the structure of this product in any way.

Our products have been tested to meet specific safety measures as they were originally intended to be sold. Any modifications will present the risk of creating significant safety issues which NJ will not be responsible for.

Proper use

- DO NOT** use for commercial purposes
- DO NOT** frolic on bookcase
- DO NOT** use bookcase as foot stool
- DO NOT** leave spilled liquid on shelves
- DO NOT** use bookcase if damaged
- DO NOT** make temporary repairs
- DO NOT** use outdoors



We are only in business if you're happy

For starters, thanks for being you.

☎ Toll-free at 1-866-619-1004

✉ Help@nathanjames.com

🌐 NathanJames.com/help

We do our best to ensure your furniture arrives without any problems, but occasionally mistakes happen—as humans we are imperfect beings. In the event that a part is damaged or missing, we will be more than happy to provide you with replacement part(s) for free.

Warranty

This product comes with a lifetime warranty from the date of purchase. Please use your phone to scan the QR code to register your product or visit <https://goo.gl/i9dk3q>

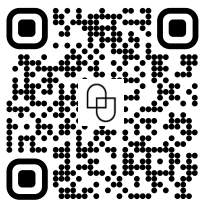

Did we do alright? Please spread the love!

If you are happy with your product, tell your friends and family about us or even better leave us a review online. Spreading the word gives us the opportunity to make more people happy and keep our prices low for your next purchase.

Brooklyn Burden

Founder, Nathan James