

# Recliner Sofa

## Model

### Loveseat Recliner

(3 Boxes Refer to pages 1-9)



Scan the QR code for the installation video

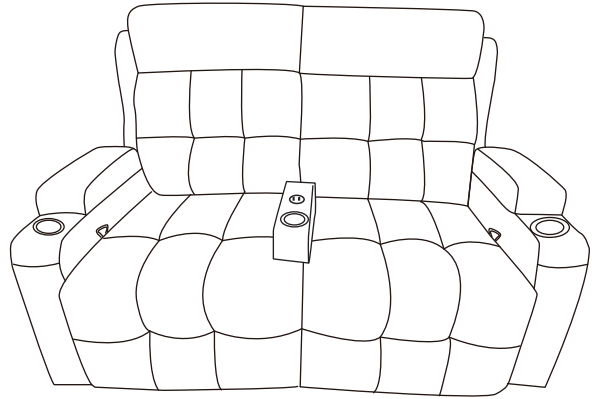

### Recliner sofa

(4 Boxes Refer to pages 10-16)



Scan the QR code for the installation video

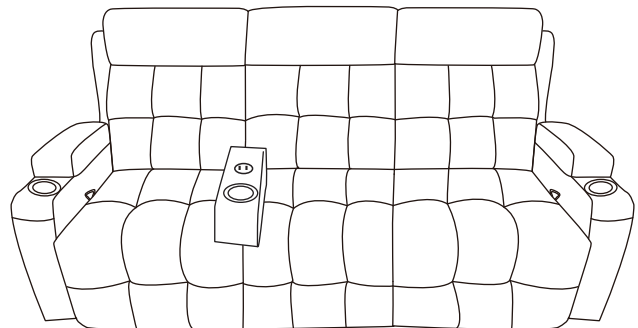

### Recliner sofa

(5 Boxes Refer to pages 17-25)



Scan the QR code for the installation video

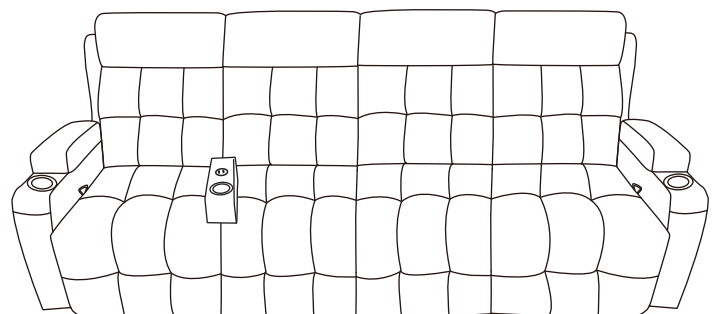

(Note:

1. This is a universal instruction, please refer to the corresponding page according to the model you purchased.
2. If you have any questions after receiving the sofa, please contact us in time and provide pictures. We will try our best to help you solve it.

## **Maintenance Tips**

1. Regular Cleaning
2. Conditioning
3. Avoid Direct Sunlight
4. Handle Spills Promptly
5. Vacuum Regularly

## **Precautions**

1. Avoid Harsh Chemicals
2. Be Mindful of Sharp Objects
3. Avoid Excessive Heat
4. Distribute Weight Evenly

## **! CAUTIONS**

1. Please check whether all flots are installed properly, avoid sofa damage and personal injury caused by abnormal installation.
2. Leave enough | 12~14 inches between sofa back and wall avoid damaging the backrest due to violent tilting.
3. Unplug all power cord and wires connection from socket before moving the sofa chair. Disconnect all the power when not in use.
4. Don't use the sofa in direct sunlight for a long time to avoid material damage.

## **! WARNINGS**

1. Keep all flame and heat sources away from this massage sofa, avoid the sofa burning by accidental contact.
2. Never stand or sit on the edge of the footrest or backrest when the chair is tilted, avoid safety accidents caused by sofa rollover.

# Loveseat Recliner



Scan the QR code for the  
installation video





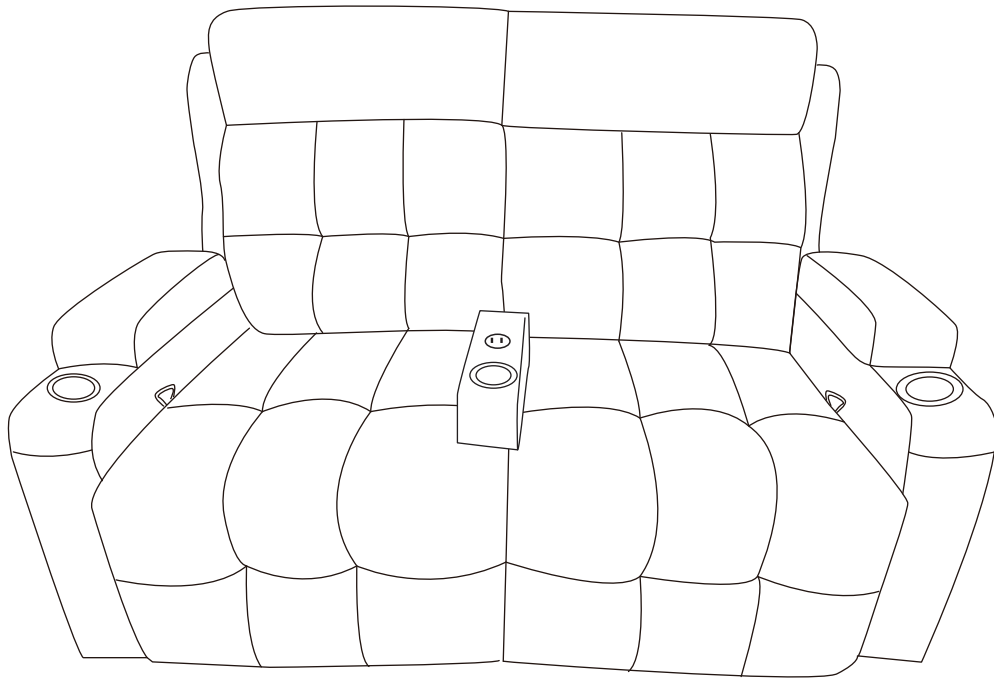

---

## Operating instruction

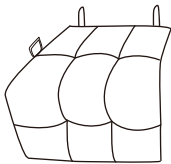

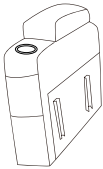
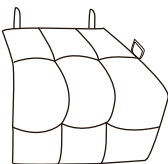

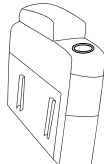

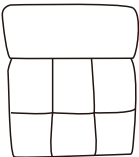
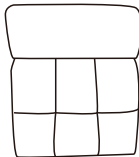
- NOTE: This sofa ships in 3 boxes. All accessories are included.
- Our package comes with some cardboard that you can unfold before installing and then put the sofa on the cardboard for assembly to prevent the fabric from wearing out.
- If you have any questions after receiving the sofa, please contact us in time and provide pictures. We will try our best to help you solve it.

# PARTS LISTING

BOX-A					
part	Description	Qty	part	Description	Qty
B1	 seat cushion(left)	1pc	C1	 Ear(left)	1pc
D1	 Arm(left)	1pc			
BOX-B					
B2	 seat cushion(right)	1pc	C2	 Ear(right)	1pc
D2	 Arm(right)	1pc	K	 1PC	
BOX-E					
A1	 Back cushion(left)	1pc	A2	 Back Cushion(right)	1pc

# PARTS LISTING

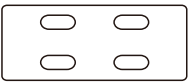
## BOXS-E

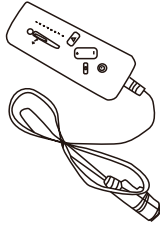
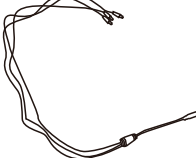
part	Description	Qty	part	Description	Qty
1		8pcs	2		4pcs
3		8pcs	4		2pcs
5		1pc	6		1pc
7		2pcs	8		1pc

# step1

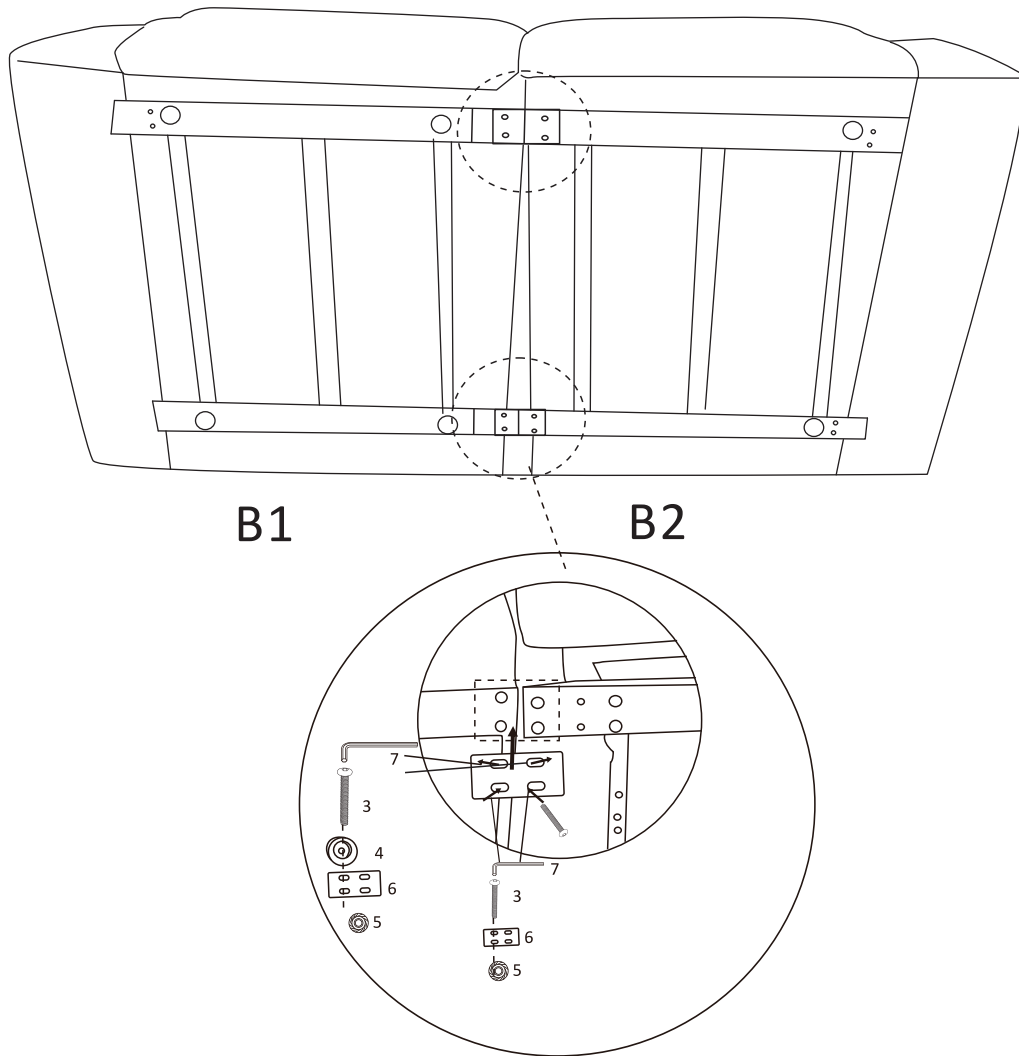

Accessories: Part 3\*4 Part 4\*4 Part 5\*8 Part 6\*2 Part 7\*1

Operating Procedure:

Connect the Part B1/B2 by using the Part 6. For the convenience to adjust parts connection, never fully tighten the screws until you finish the installation, tighten screws to 80%-90% is enough.

\* Mounting two parts 4 horizontally side by side is more stable.

## step2

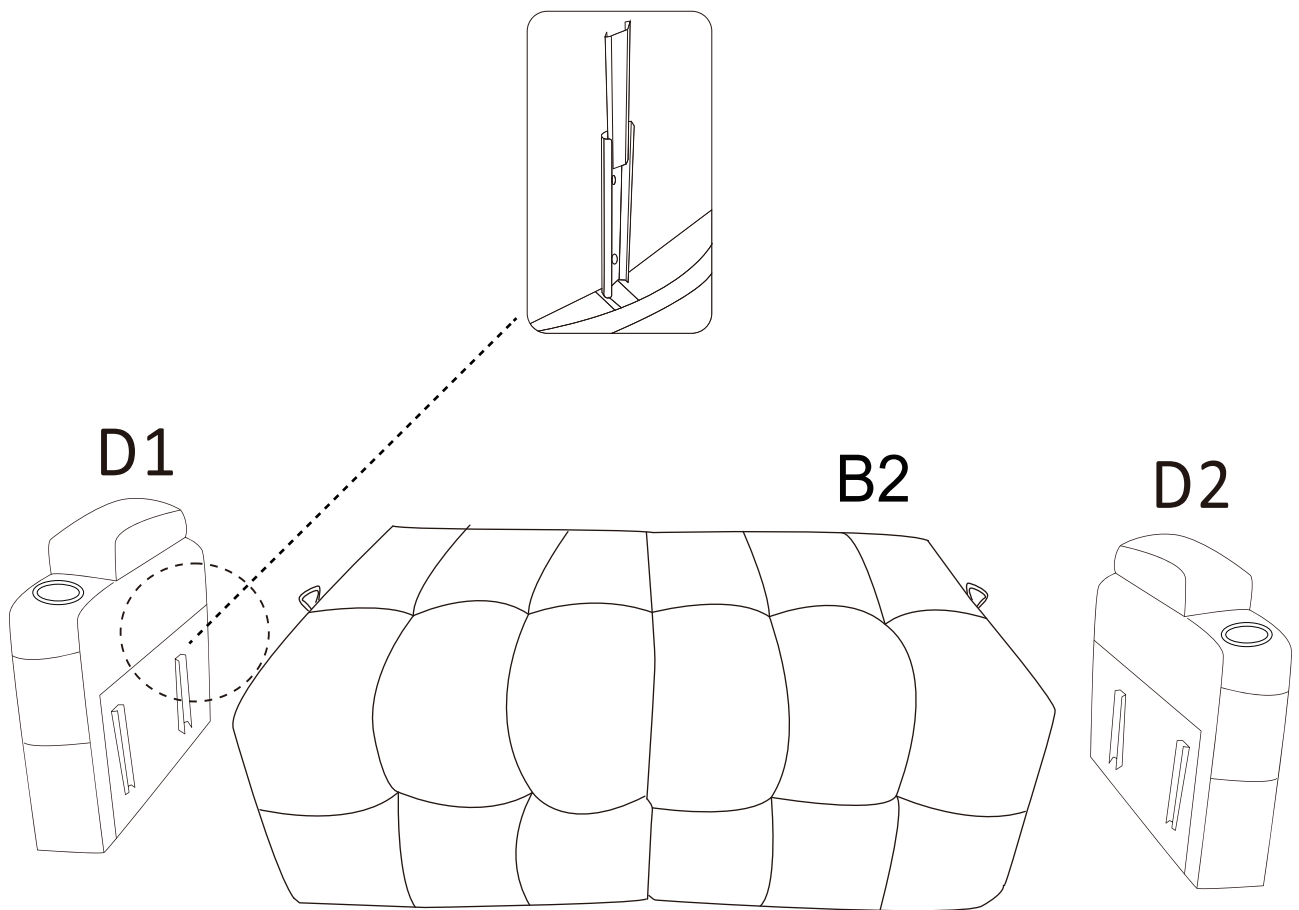

Accessories: Part D1\*1 Part D2\*1

Operating Procedure:

Insert left and right armrest pads (Part D1 Part D2) into the armrests. Align the slot and slide armrest pad forward to ensure it snaps in properly.

## step3

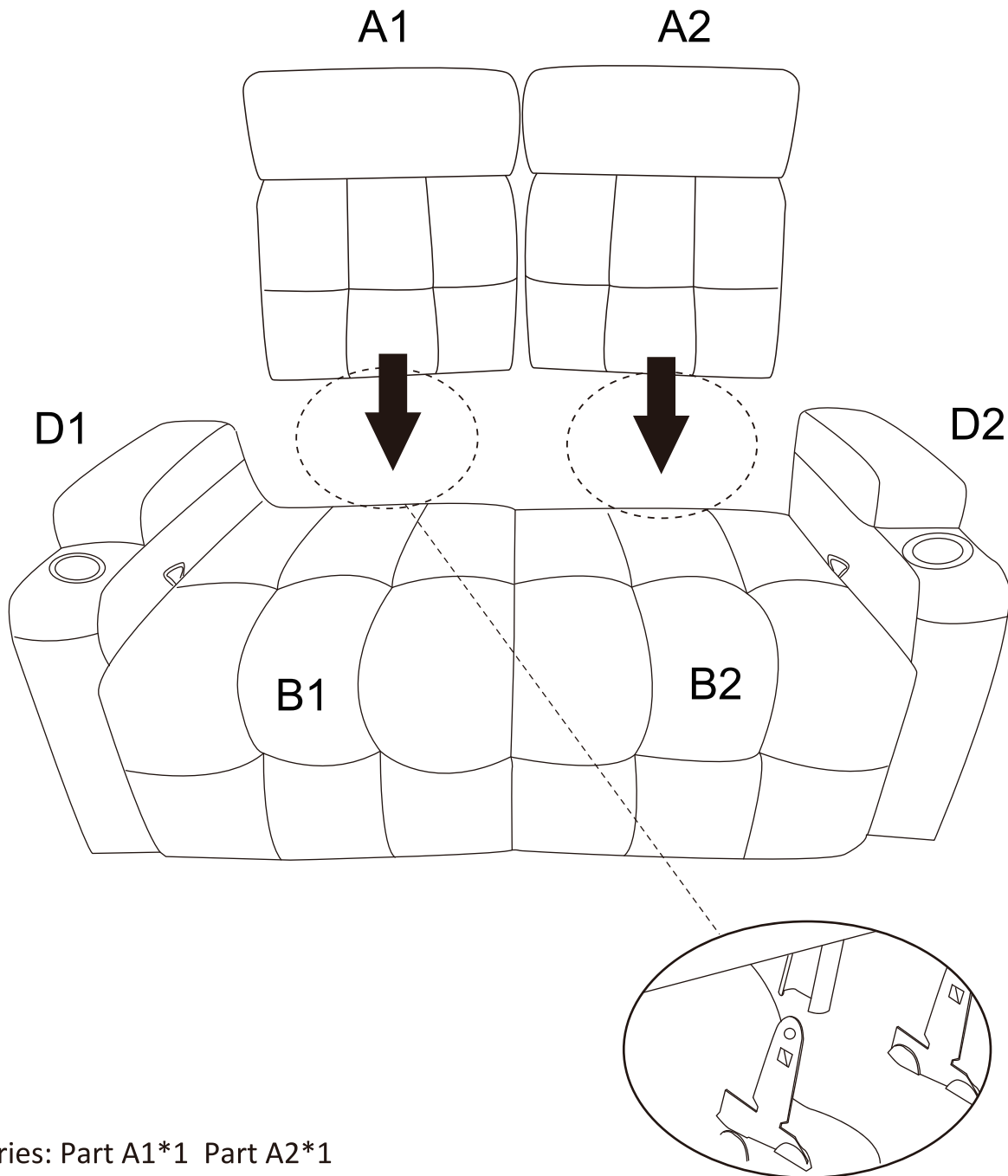

Accessories: Part A1\*1 Part A2\*1

Operating Procedure:

Align the backrests(Part A1 Part A2) with the slot on the bases(Part B1 Part B2) separately and insert them firmly, when you hear a click that's correct installation.

## step4

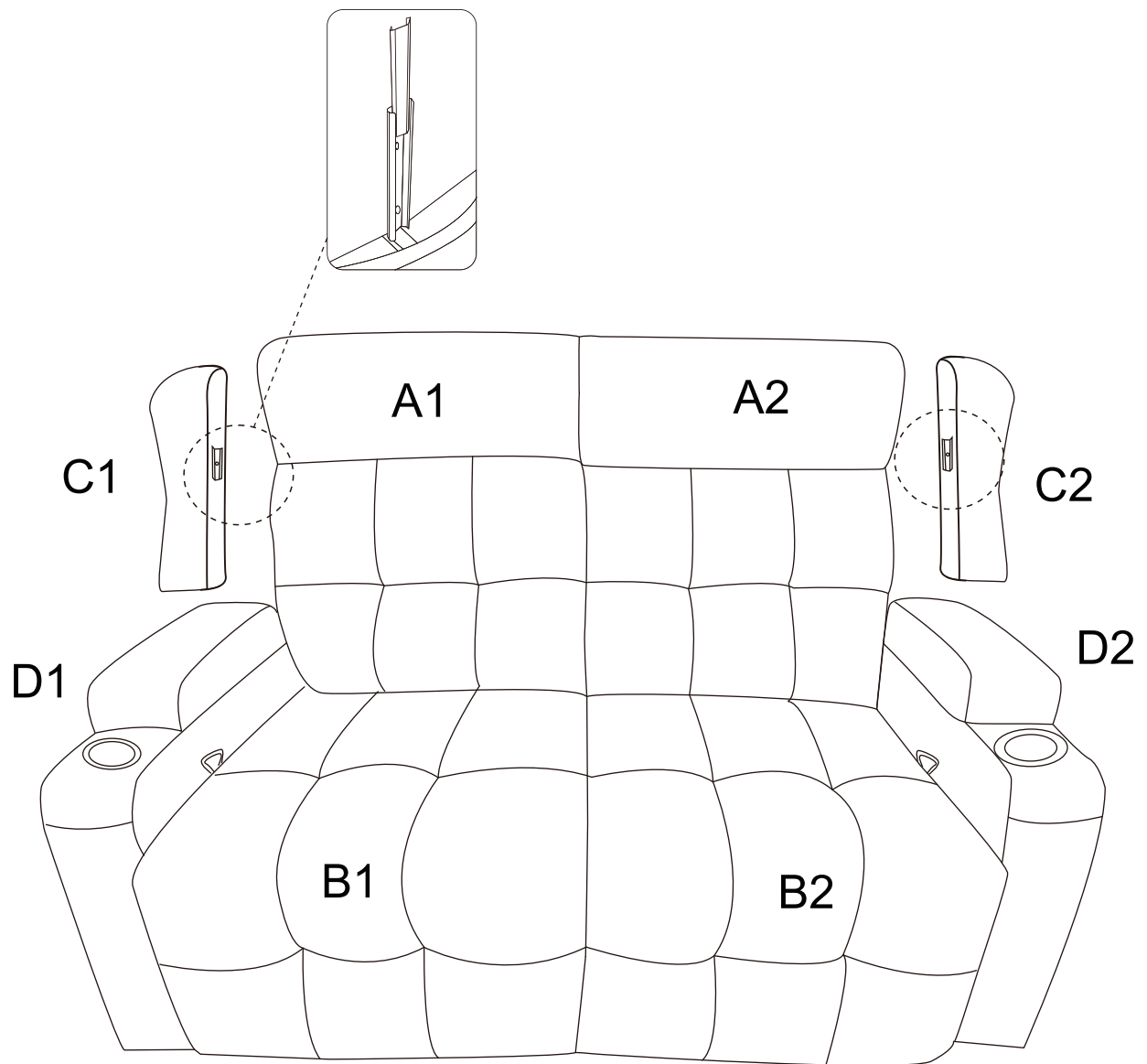

Accessories: Part C1\*1 Part C2\*1

Operating Procedure:

Align the Part C1 and Part C2 with the slot on the backrests (Part A1 Part A2) separately and insert them firmly.

# step5

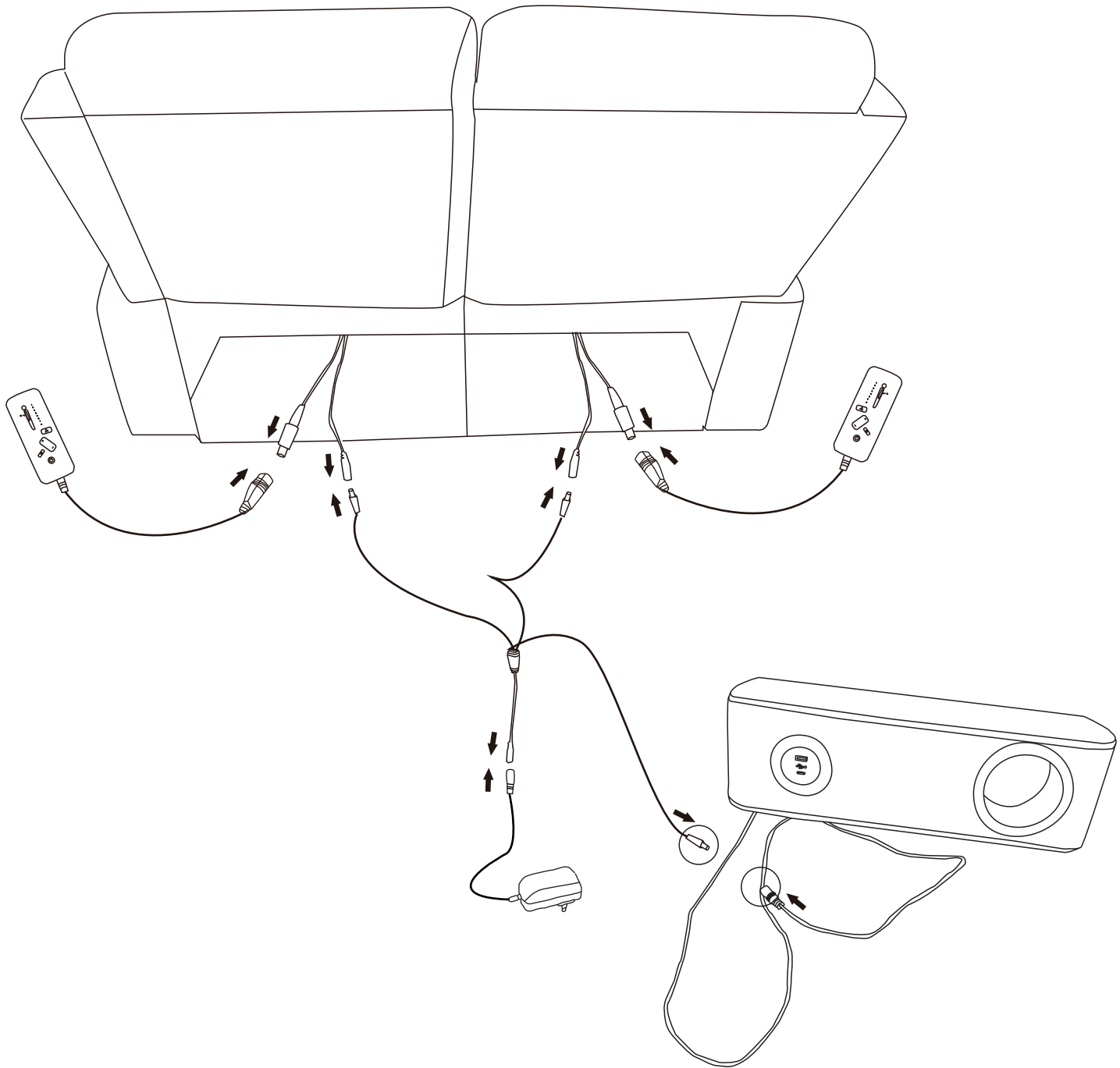

Accessories: Part 8\*1, Part 9\*2, Part 10\*1

Operating Procedure:

Connect all the wires, then plug it in and start using it.

step 6

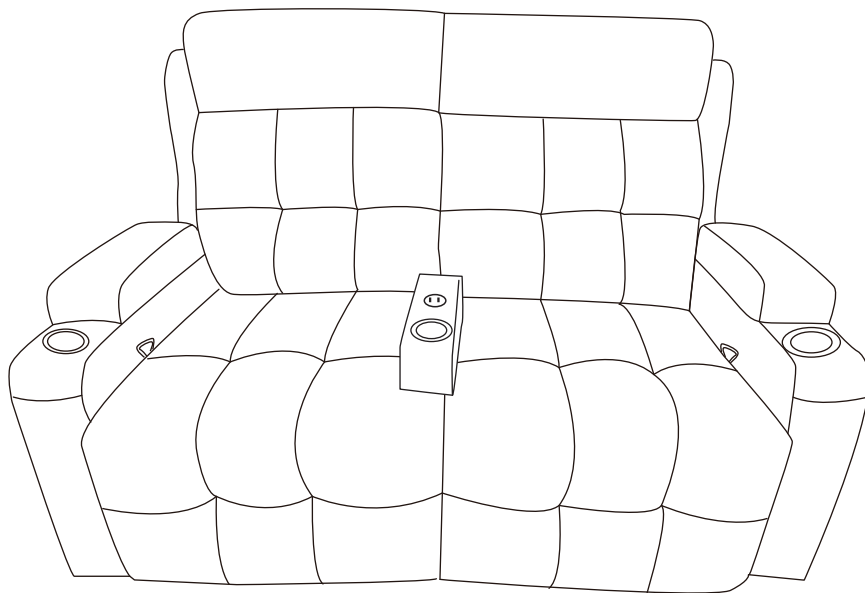
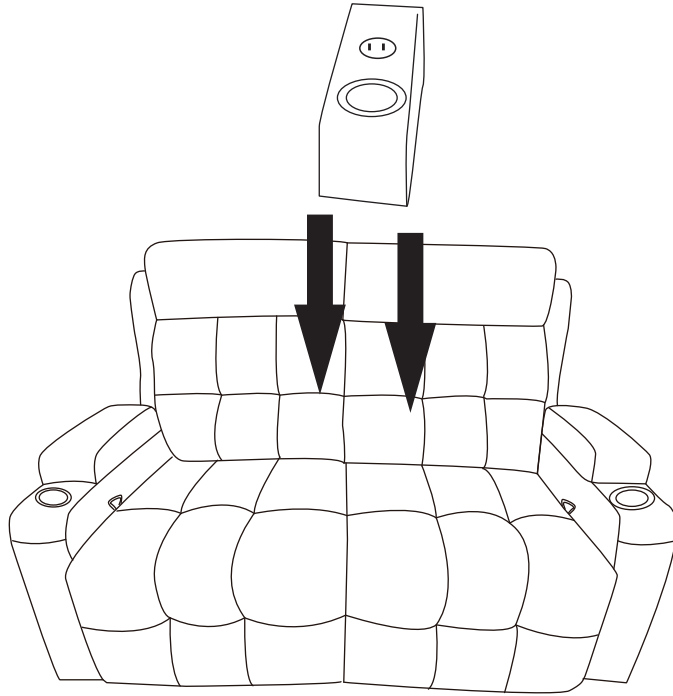

# Assembly Completed

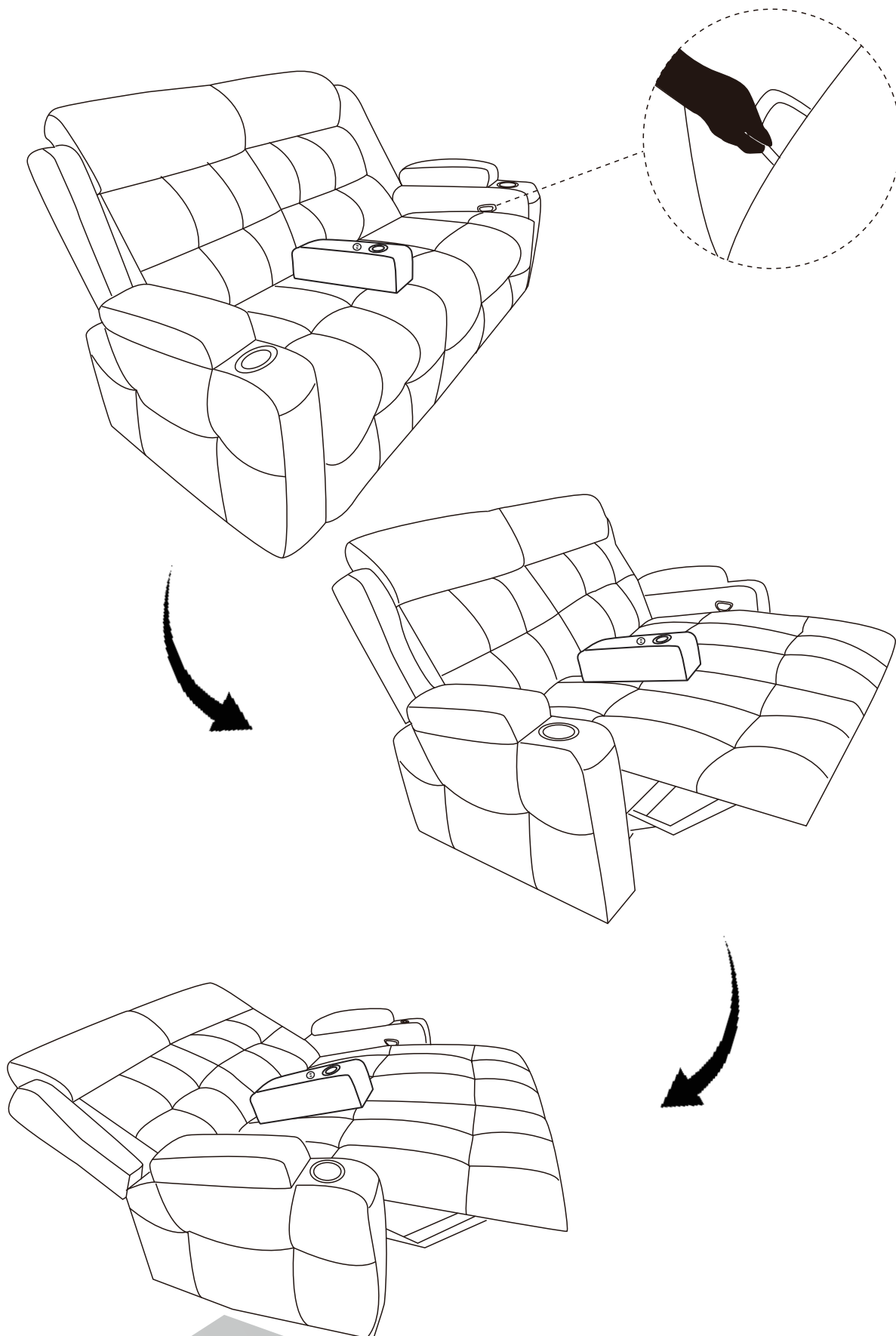

# Recliner Sofa



Scan the QR code for the  
installation video





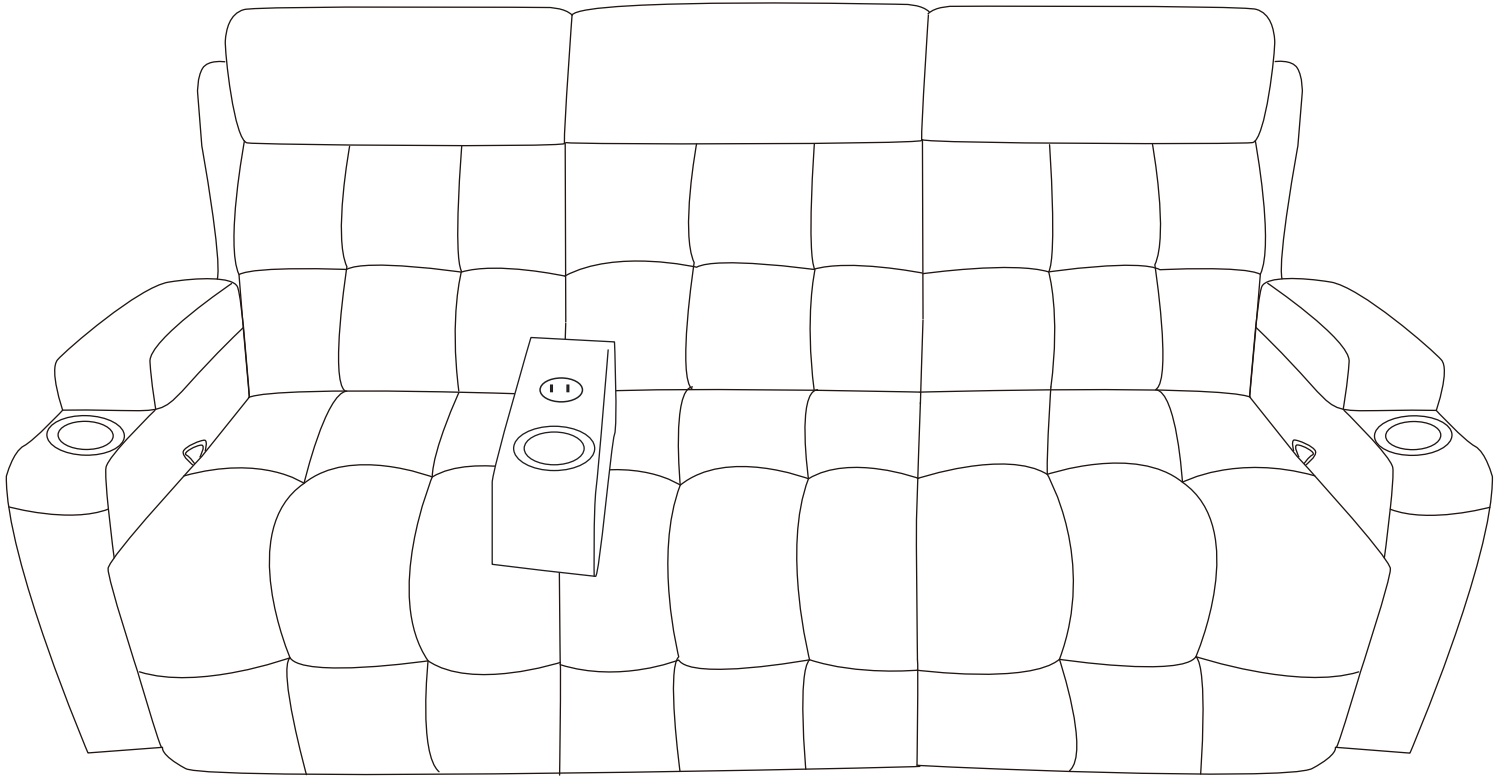

---

## Operating instruction

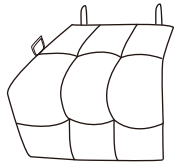

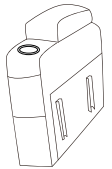
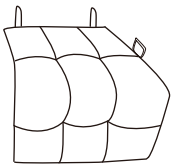

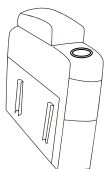

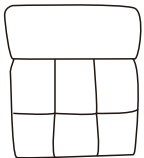
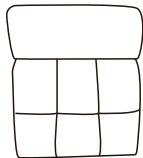

- NOTE: This sofa ships in 4 boxes. All accessories are included.
- Our package comes with some cardboard that you can unfold before installing and then put the sofa on the cardboard for assembly to prevent the fabric from wearing out.
- If you have any questions after receiving the sofa, please contact us in time and provide pictures. We will try our best to help you solve it.

# PARTS LISTING



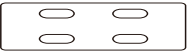

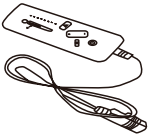
BOX-A					
part	Description	Qty	part	Description	Qty
B1	 seat cushion(left)	1pc	C1	 Ear(left)	1pc
D1	 Arm(left)	1pc			
BOX-B					
B2	 seat cushion(right)	1pc	C2	 Ear(right)	1pc
D2	 Arm(right)	1pc	K	 1PC	
BOX-E					
A1	 Back cushion(left)	1pc	A2	 Back Cushion(right)	1pc

# PARTS LISTING

## BOX-E

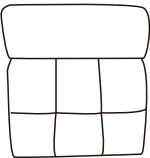
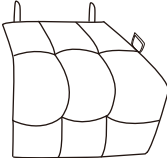
part	Description	Qty	part	Description	Qty
1		8pcs	2		4pcs
3		8pcs	4		2pcs
5		1pc	6		1pc
7		2pcs	8		1pc

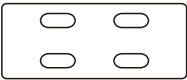
## BOX-D

G	 Back cushion (mid)	1pc	H	 Seat cushion (mid)	1pc
3		8pcs	4		4pcs
6		2pcs	7		1pc
8		1pc			

# Step 1

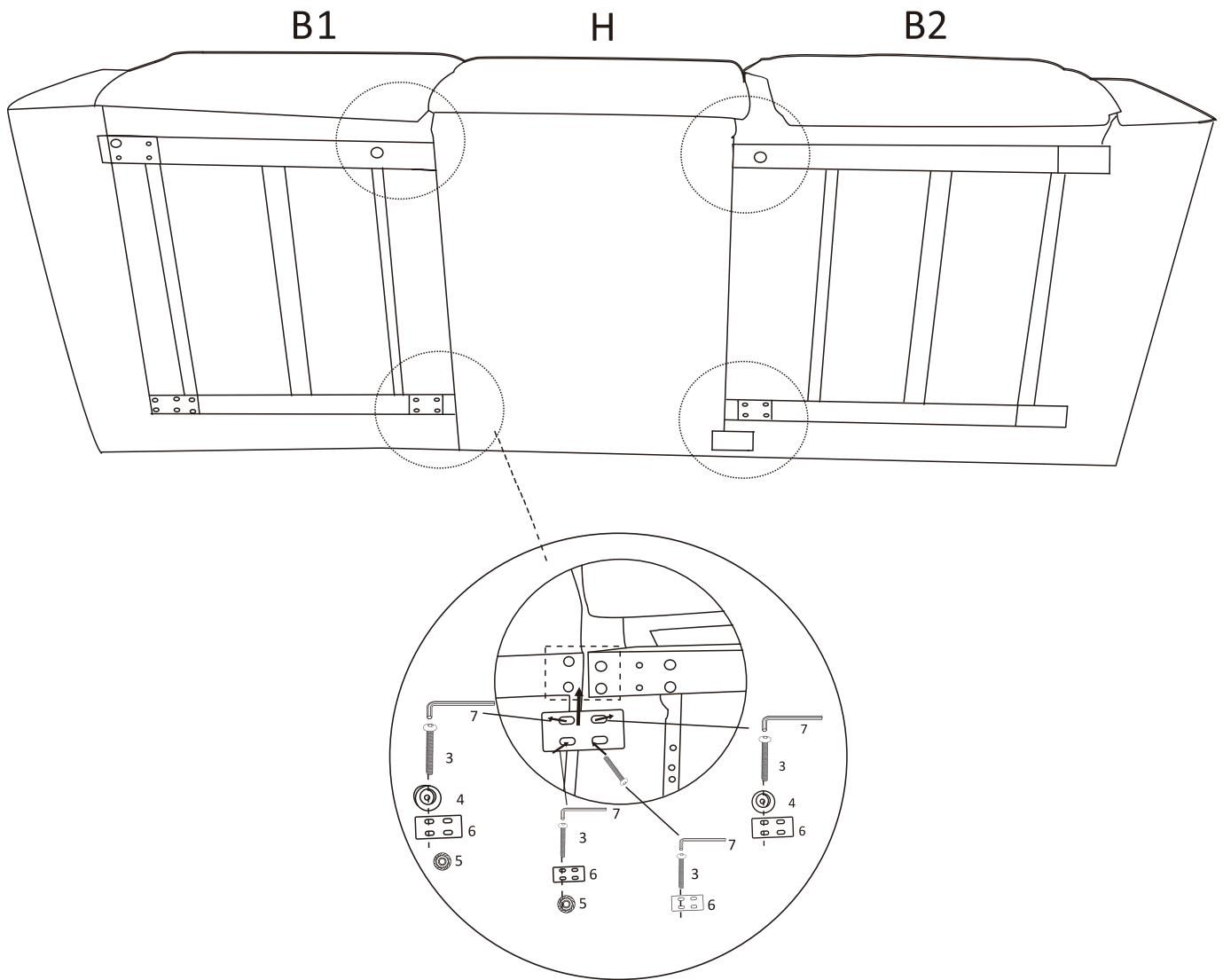

Accessories: Part 3\*16 Part 4\*8 Part 5\*8 Part 6\*4

Operating Procedure:

Connect the Part B1/B2/H by using the Part 6. For the convenience to adjust parts connection, never fully tighten the screws until you finish the installation, tighten screws to 80%-90% is enough.

Note: The Part 4 is used around the H part, and Part 5 is used to fix the Part 6 near the chair.

**\* Mounting Two parts 4 horizontally side by side is more stable.**

## step2

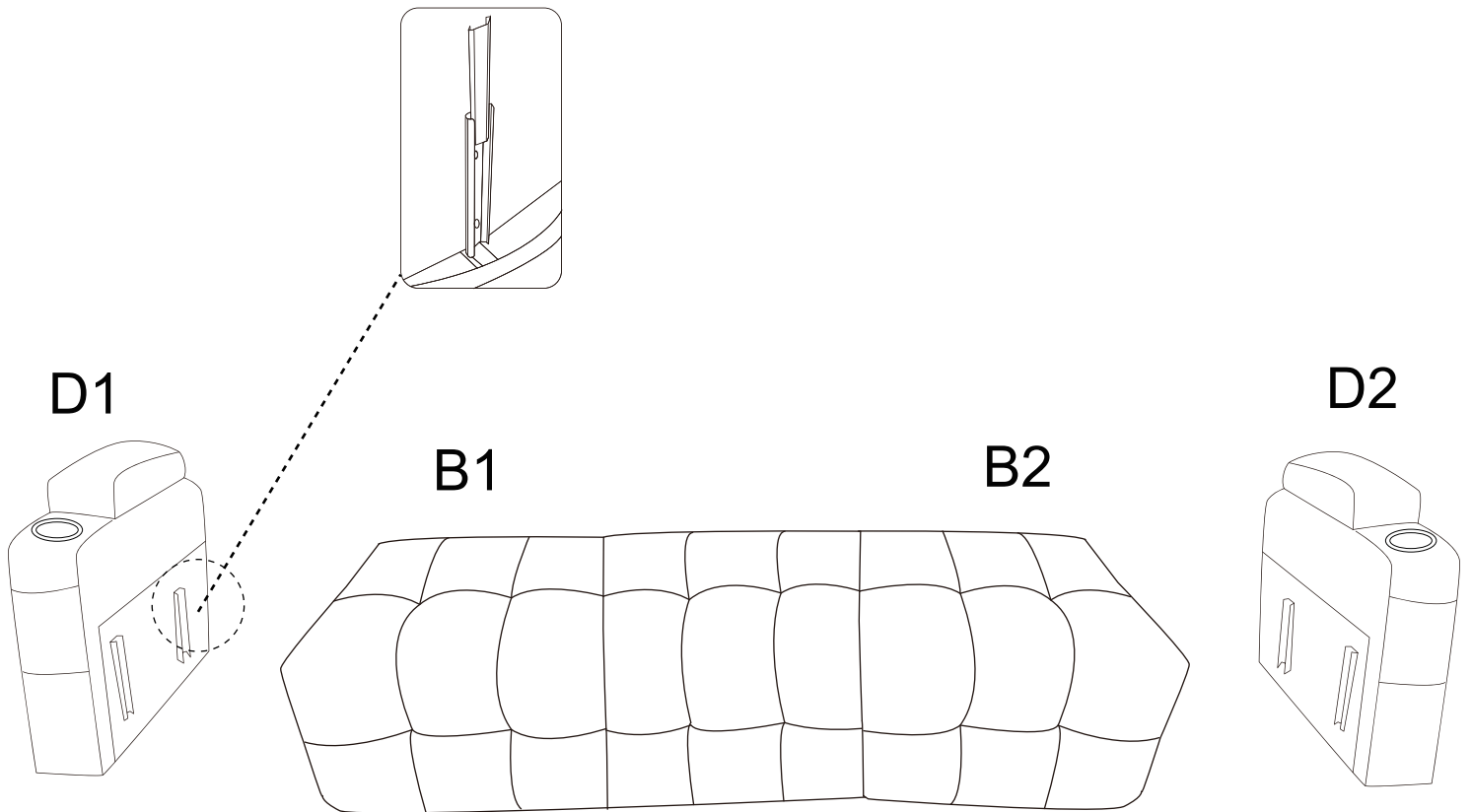

Accessories: Part D1\*1 Part D2\*1

Operating Procedure:

Insert left and right armrest pads (Part D1 Part D2) into the armrests. Align the slot and slide armrest pad forward to ensure it snaps in properly.

# step3

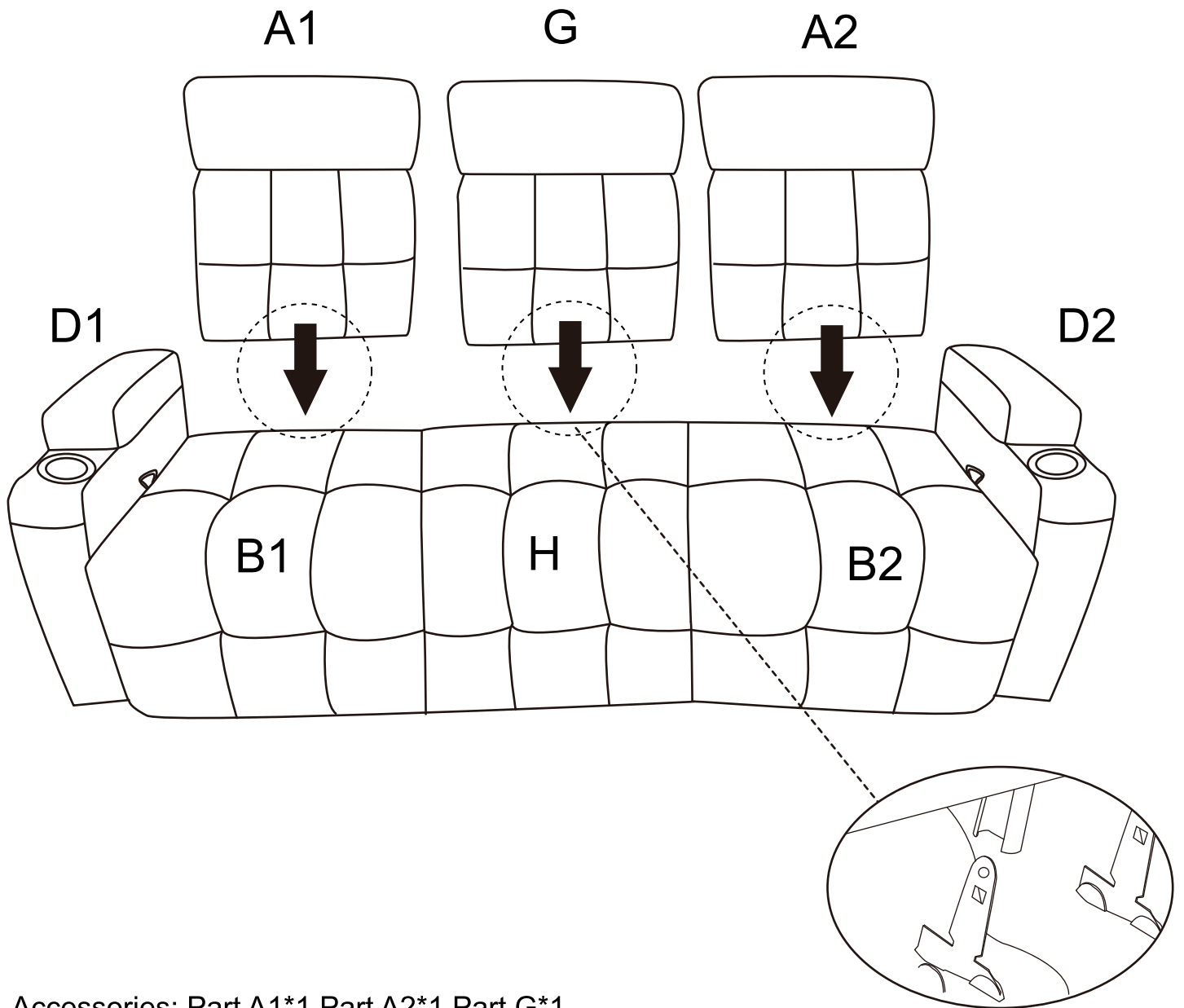

Accessories: Part A1\*1 Part A2\*1 Part G\*1

Operating Procedure:

Align the backrests(Part A1 Part A2 Part G) with the slot on the bases(Part B1 Part B2 Part H ) separately and insert them firmly, when you hear a click that's correct installation

## step4

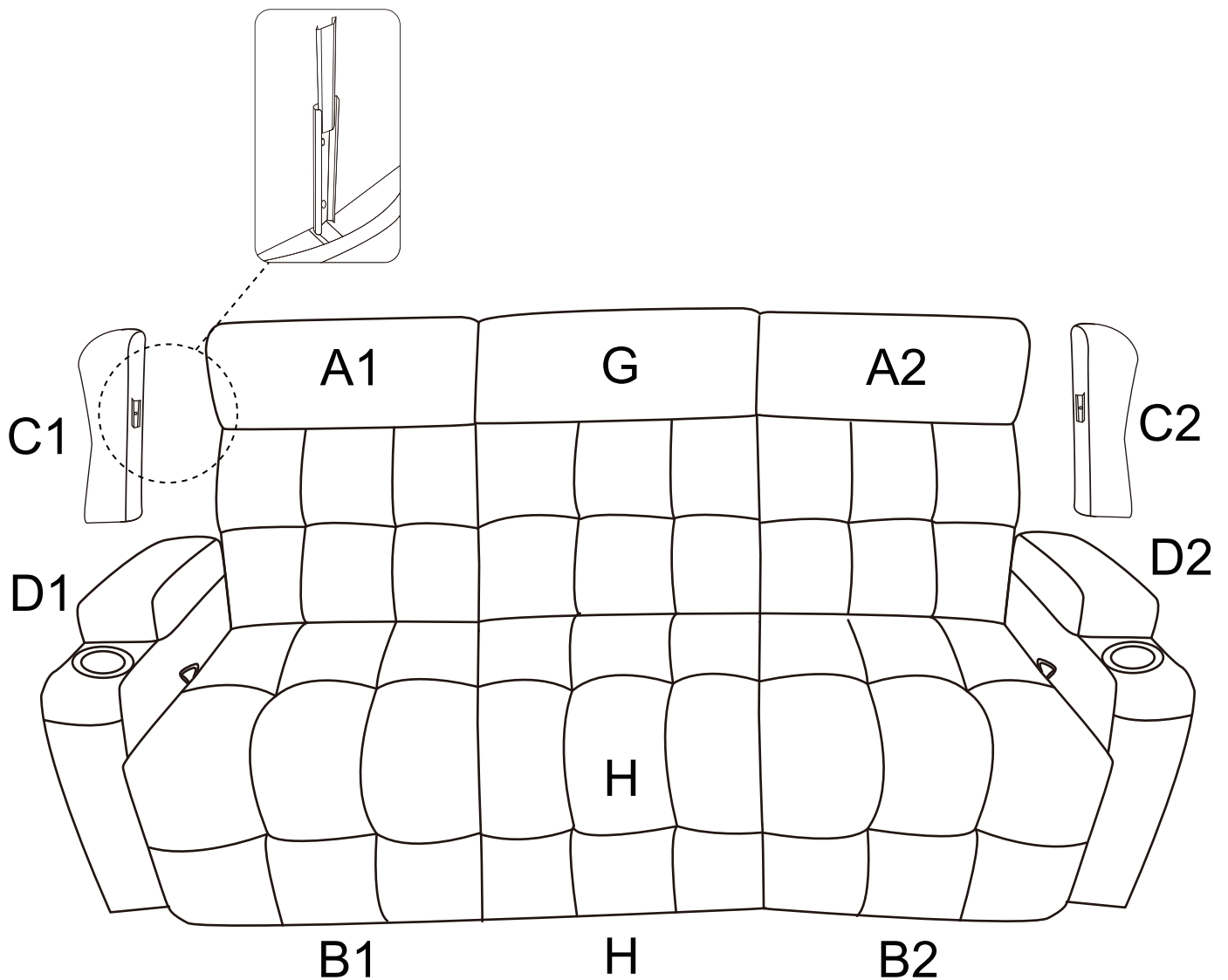

Accessories: Part C1\*1 Part C2\*1

Operating Procedure:

Align the Part C1 and Part C2 with the slot on the backrests (Part A1 Part A2) separately and insert them firmly.

# step5

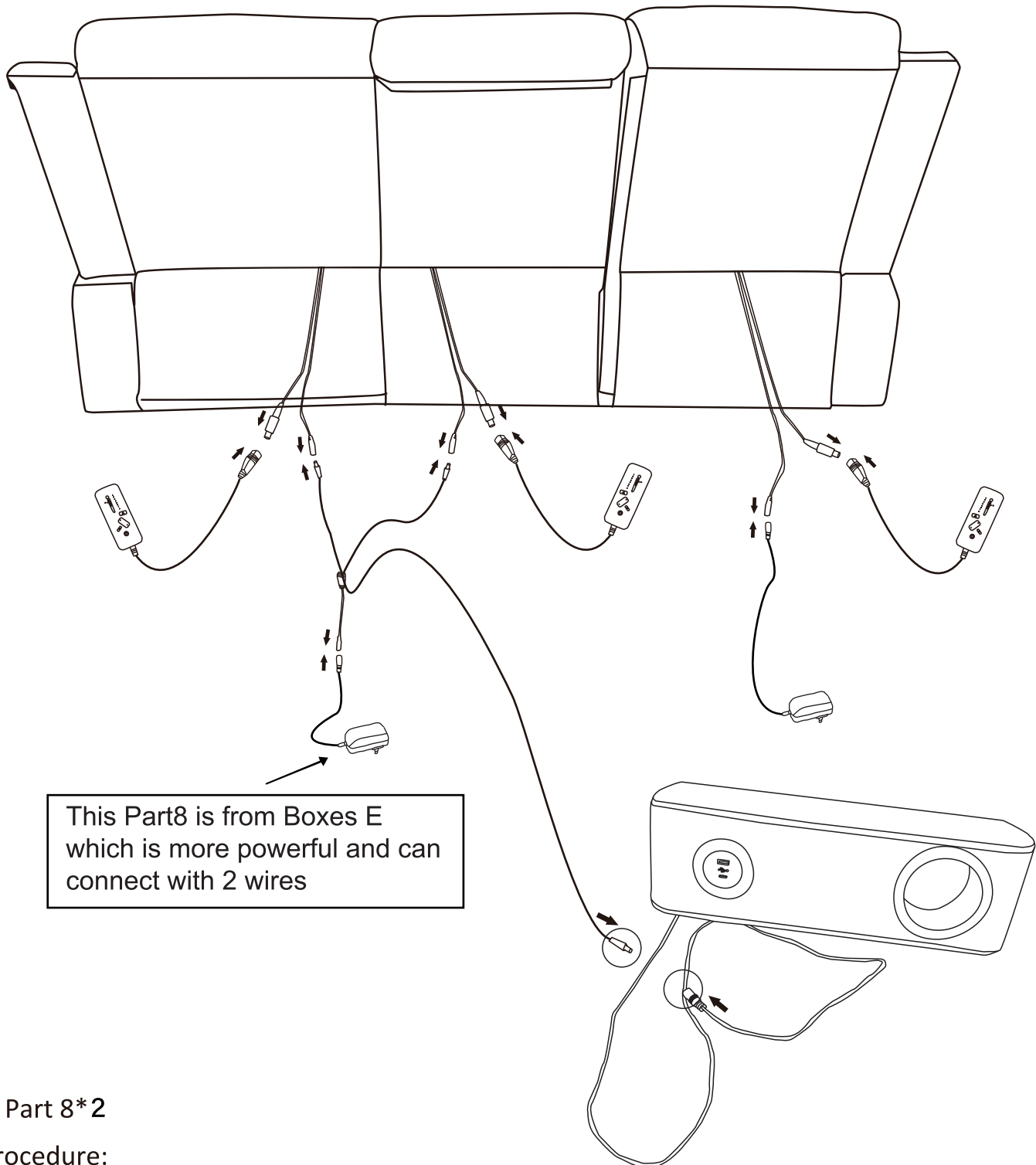

Accessories: Part 8\*2

Operating Procedure:

Connect the wires on the plug, then plug it in and start using it.

step 6

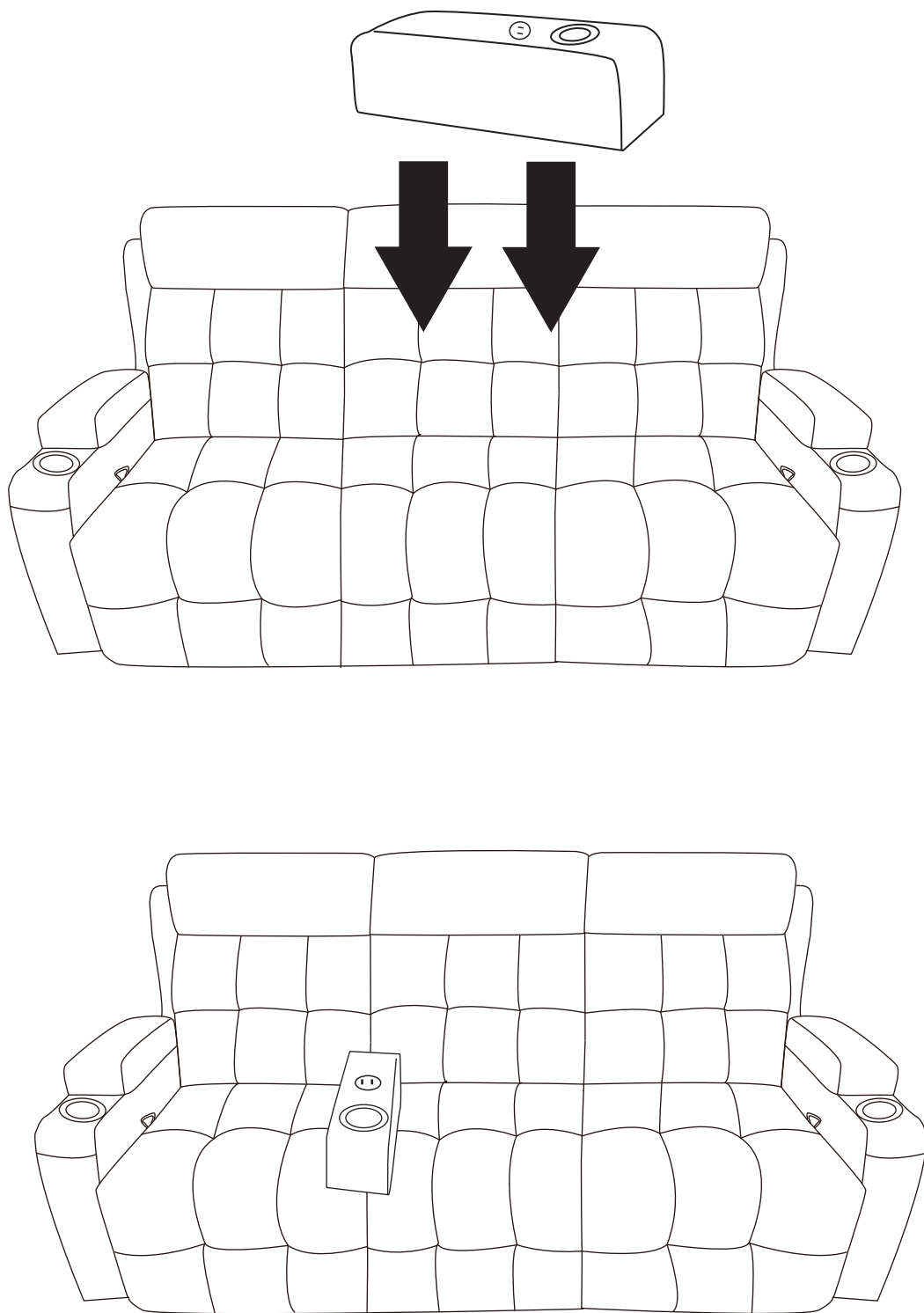

# Assembly Completed

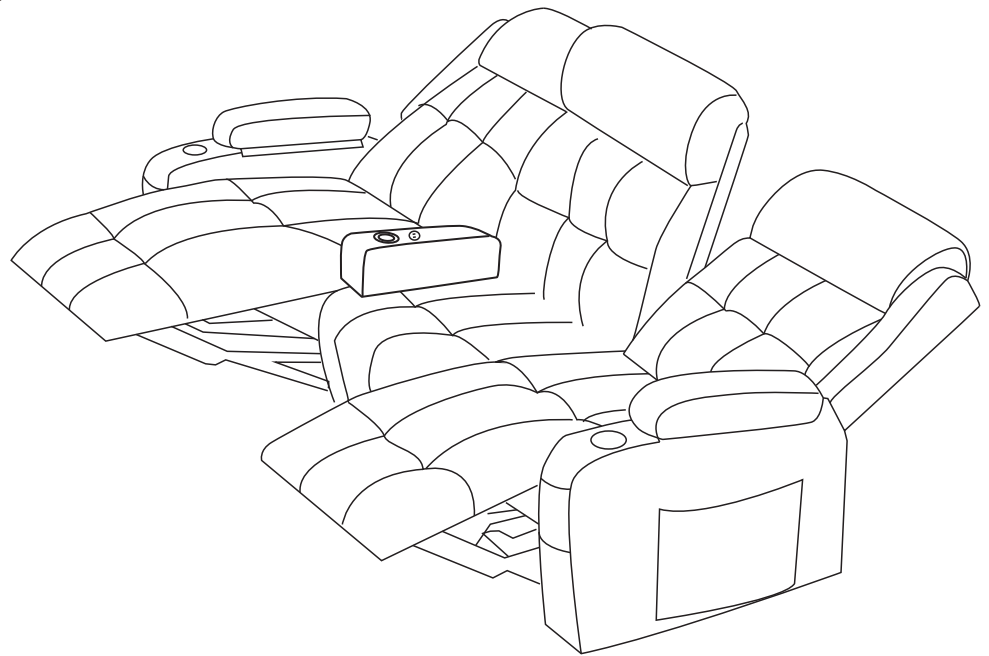
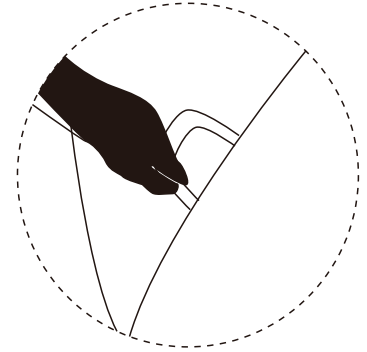
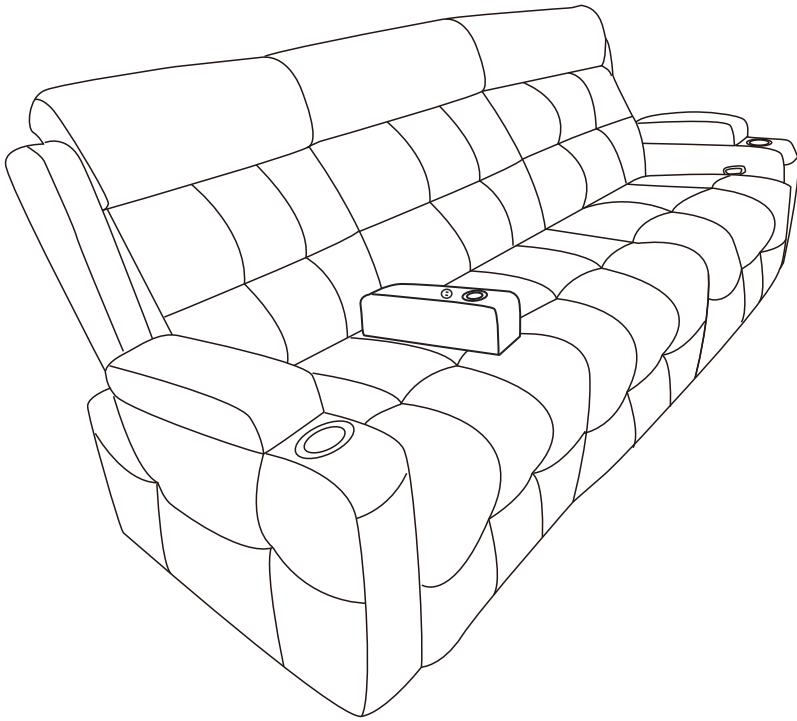

# Recliner Sofa



Scan the QR code for the  
installation video





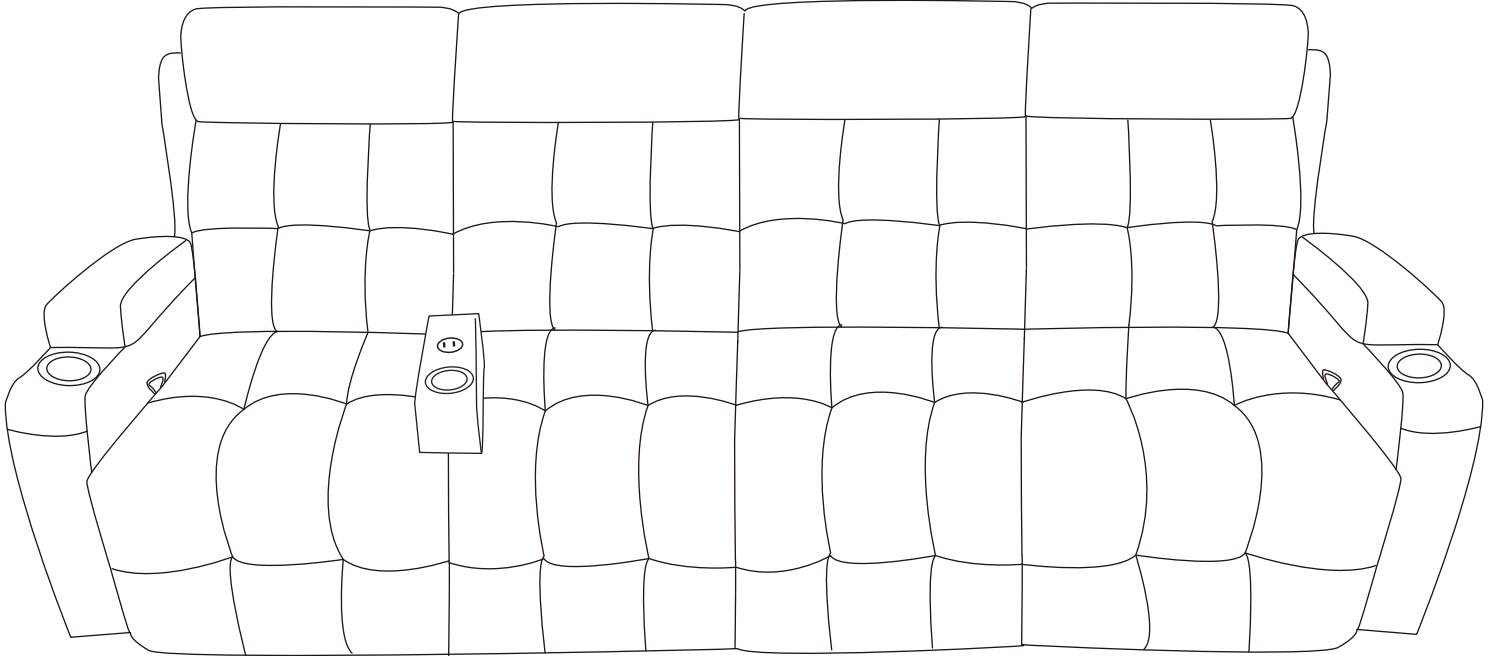

---

## Operating instruction

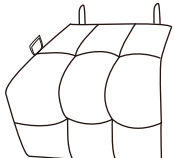

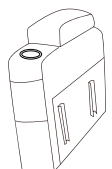
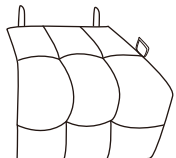

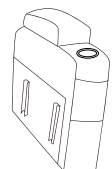

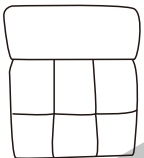
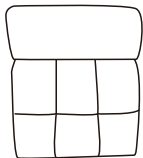





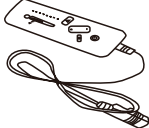

- NOTE: This sofa ships in 5 boxes. All accessories are included.
- Our package comes with some cardboard that you can unfold before installing and then put the sofa on the cardboard for assembly to prevent the fabric from wearing out.
- If you have any questions after receiving the sofa, please contact us in time and provide pictures. We will try our best to help you solve it.

# PARTS LISTING

BOX-A					
part	Description	Qty	part	Description	Qty
B1	 seat cushion(left)	1pc	C1	 Ear(left)	1pc
D1	 Arm(left)	1pc			
BOX-B					
B2	 seat cushion(right)	1pc	C2	 Ear(right)	1pc
D2	 Arm(right)	1pc	K	 1PC	
BOX-E					
A1	 Back cushion(left)	1pc	A2	 Back Cushion(right)	1pc

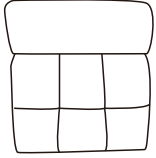
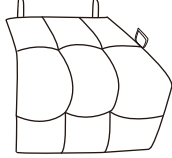
# PARTS LISTING

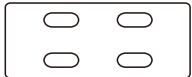
BOX-E					
part	Description	Qty	part	Description	Qty
1		8pcs	2		4pcs
3		8pcs	4		2pcs
5		1pc	6		1pc
7		2pcs	8		1pc

BOX-D (2 Boxes)					
G	 Back cushion (mid)	1pc	H	 Seat cushion (mid)	1pc
3		8pcs	4		4pcs
6		2pcs	7		1pc
8		1pc			

# Step 1

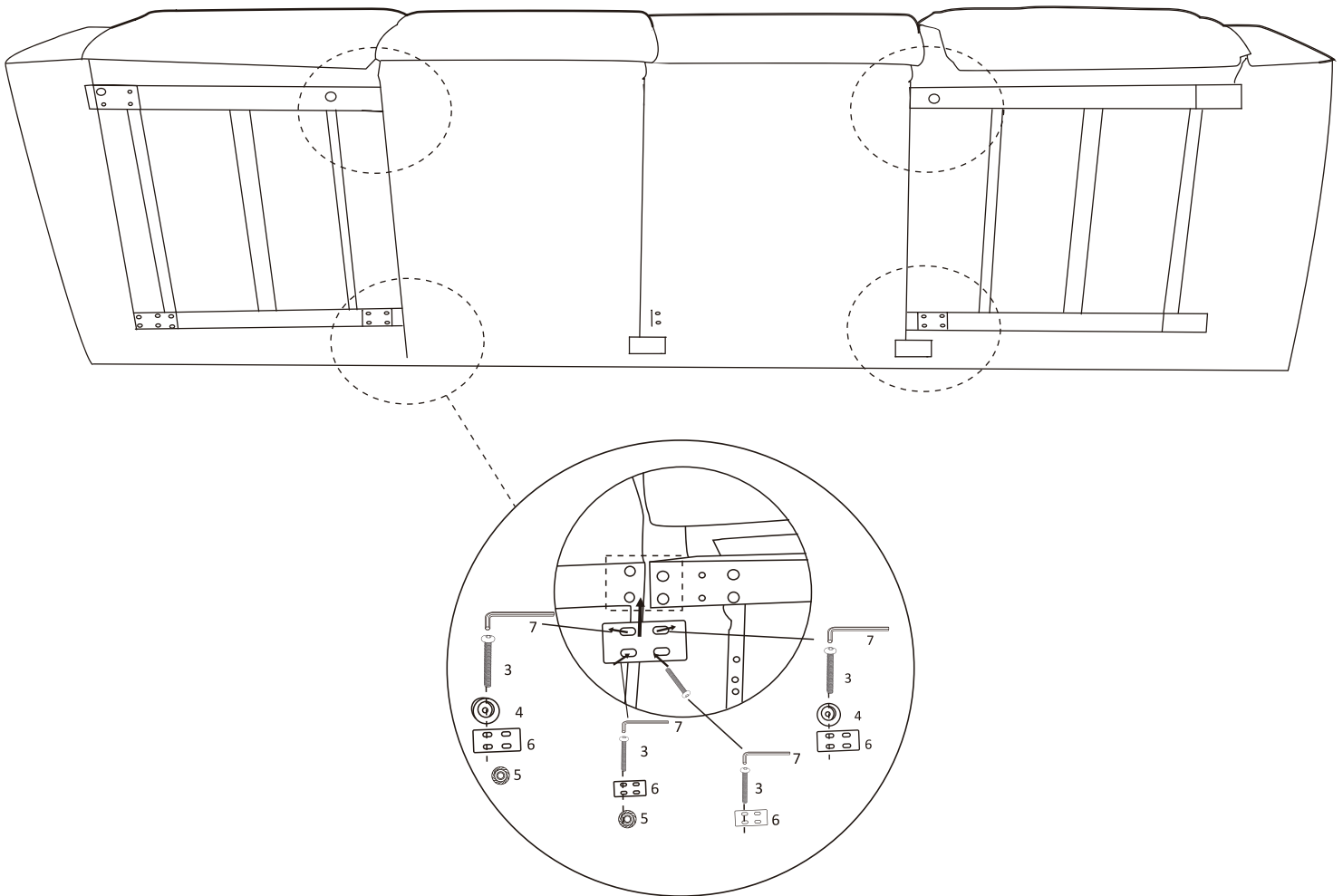

Accessories: Part 3\*16 Part 4\*8 Part 5\*8 Part 6\*4

Operating Procedure:

Connect the Part B1/B2/H\*2 by using the Part 6. For the convenience to adjust parts connection, never fully tighten the screws until you finish the installation, tighten screws to 80%-90% is enough.

Note: The Part 4 is used around the H part, and Part 5 is used to fix the Part 6 near the chair.

**\* Mounting Two parts 4 horizontally side by side is more stable.**

## step2

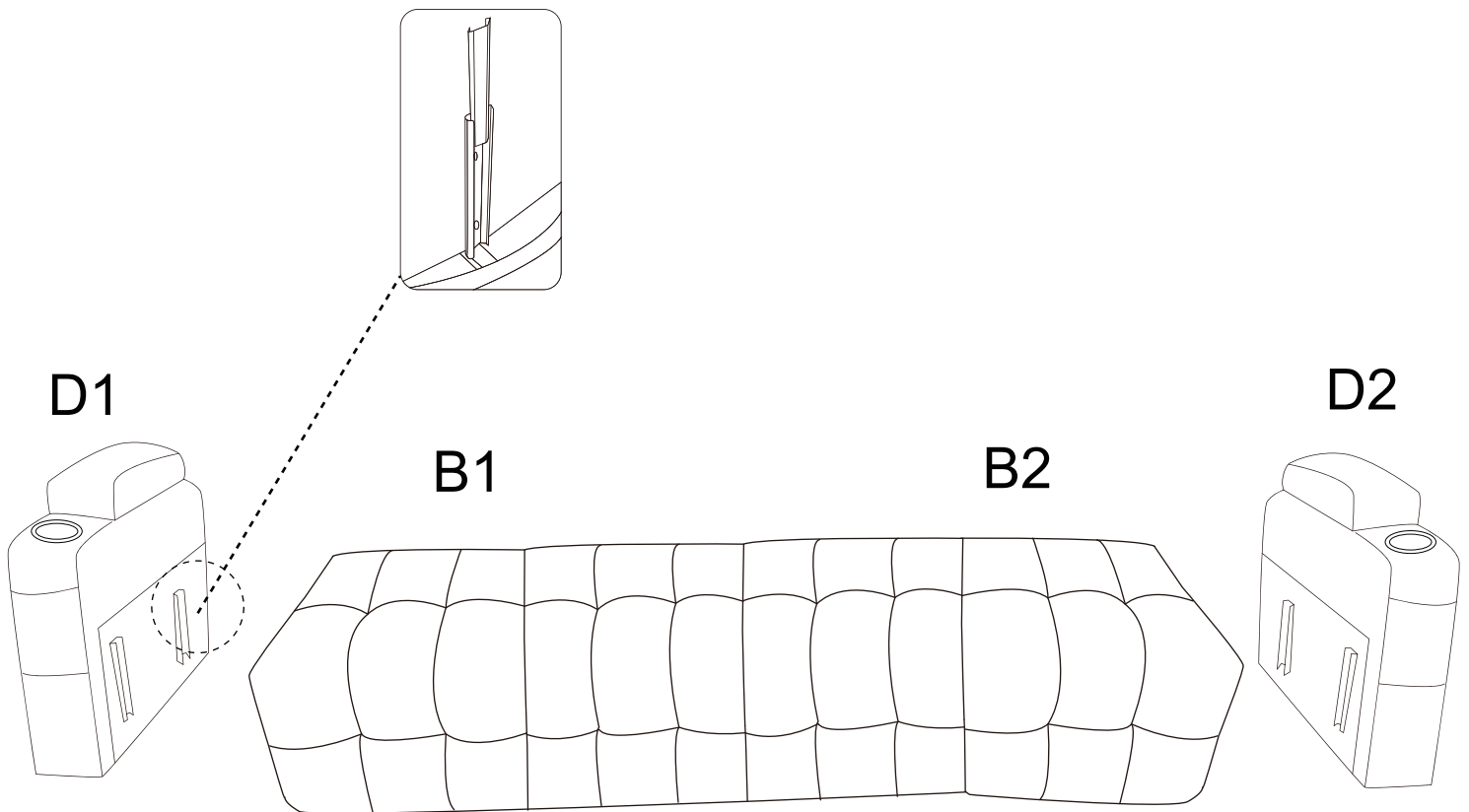

Accessories: Part D1\*1 Part D2\*1

Operating Procedure:

Insert left and right armrest pads (Part D1 Part D2) into the armrests. Align the slot and slide armrest pad forward to ensure it snaps in properly.

# step3

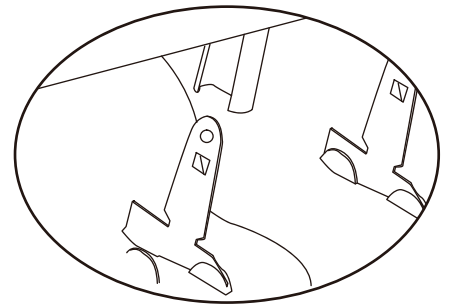
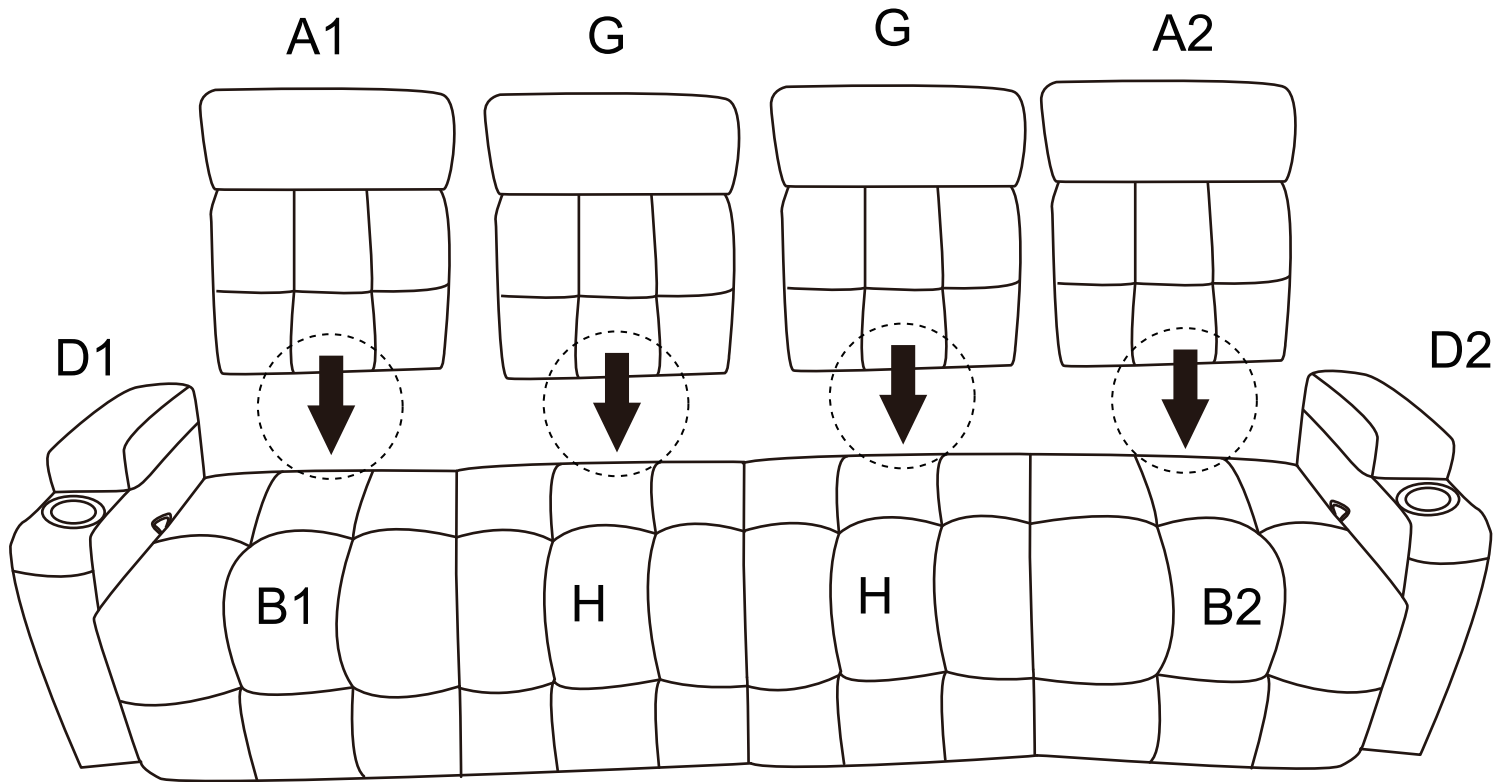

Accessories: Part A1\*1 Part A2\*1 Part G\*2

Operating Procedure:

Align the backrests(Part A1 Part A2 Part G) with the slot on the bases(Part B1 Part B2 Part H ) separately and insert them firmly, when you hear a click that's correct installation

## step4

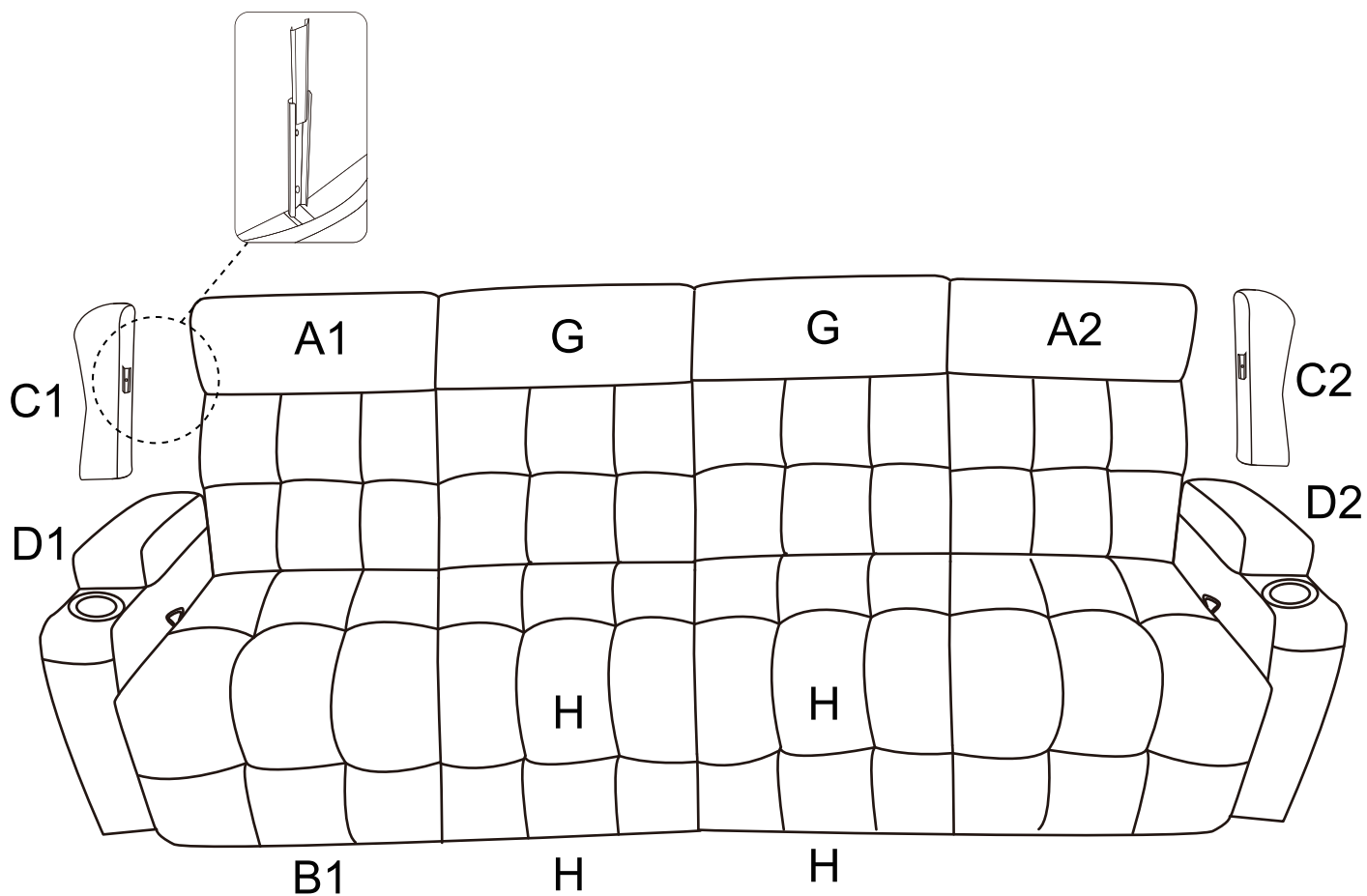

Accessories: Part C1\*1 Part C2\*1

Operating Procedure:

Align the Part C1 and Part C2 with the slot on the backrests (Part A1 Part A2) separately and insert them firmly.

# step5

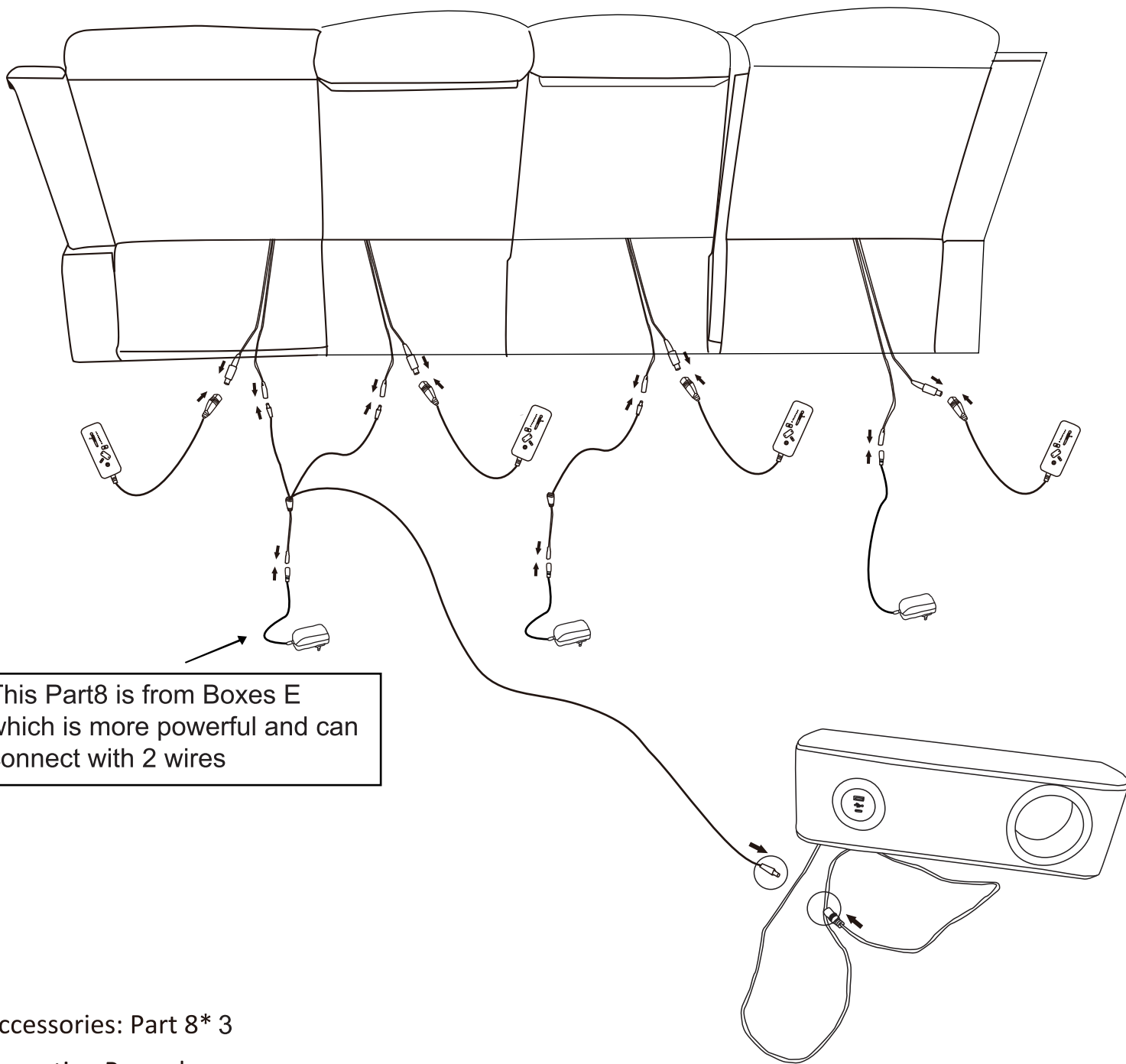

This Part8 is from Boxes E which is more powerful and can connect with 2 wires

Accessories: Part 8\* 3

Operating Procedure:

Connect the wires on the plug, then plug it in and start using it.

step 6

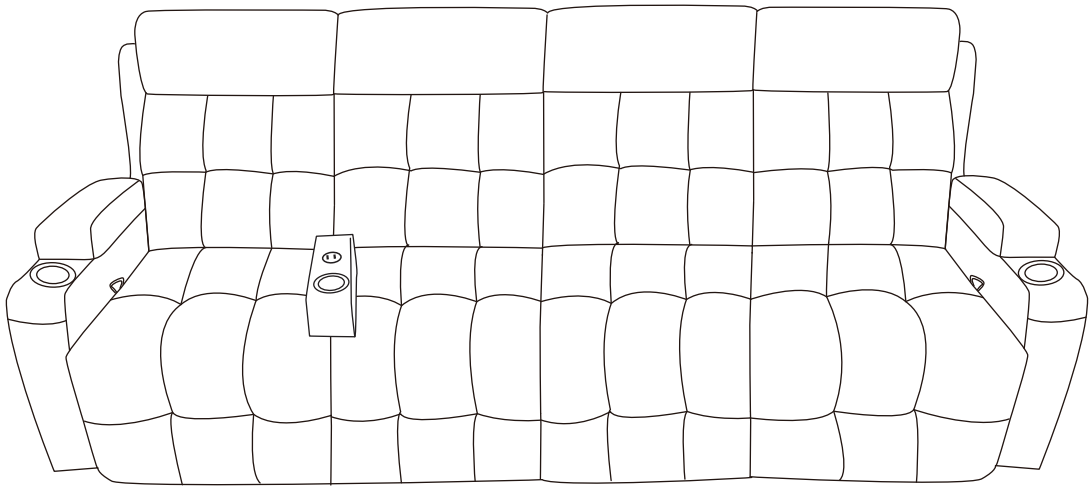
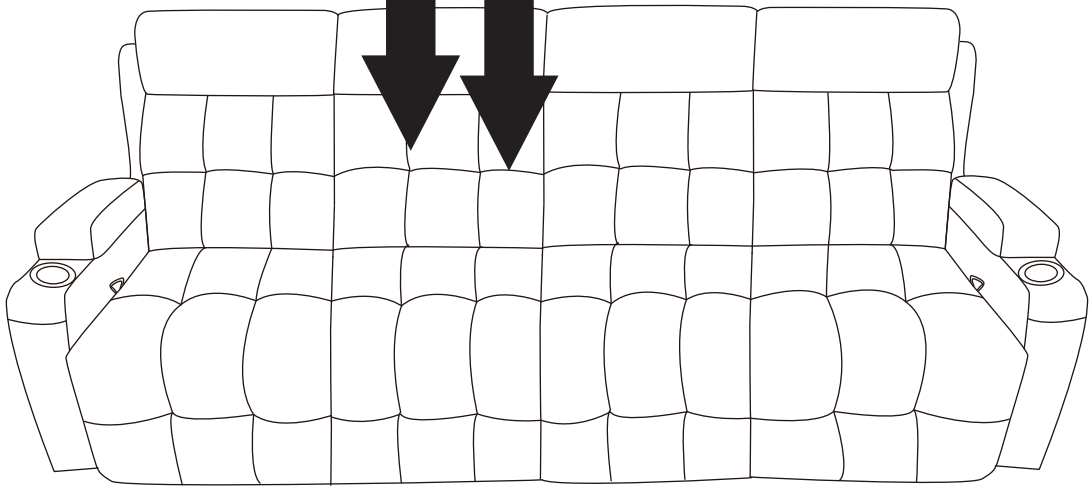
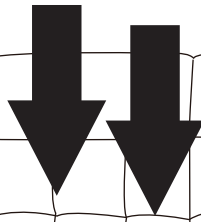
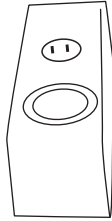

# Assembly Completed

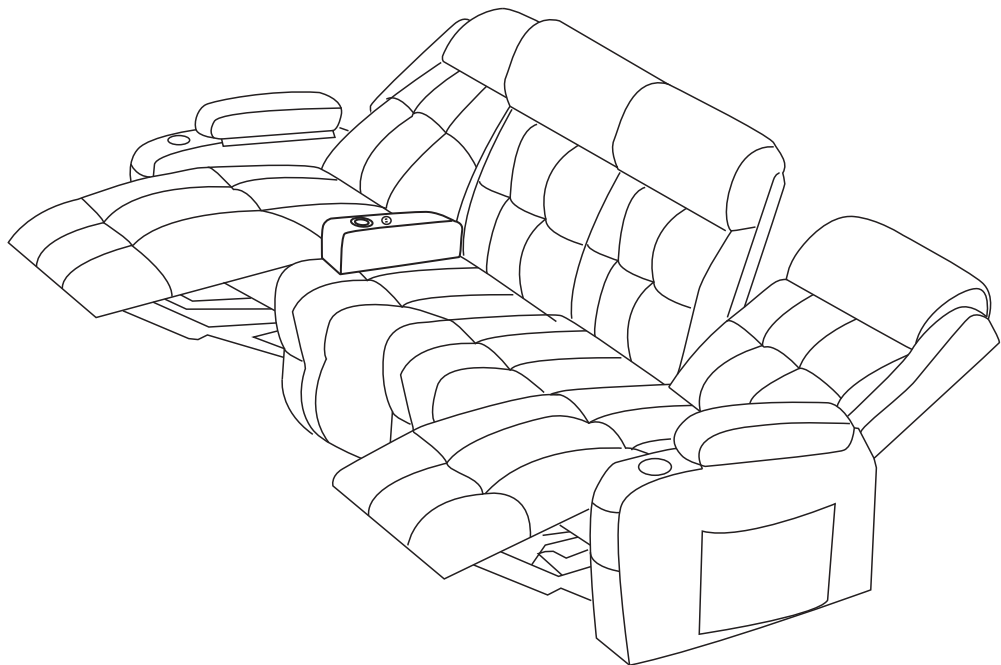
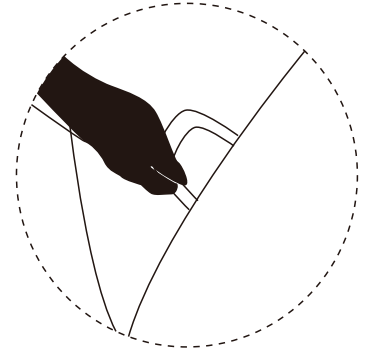
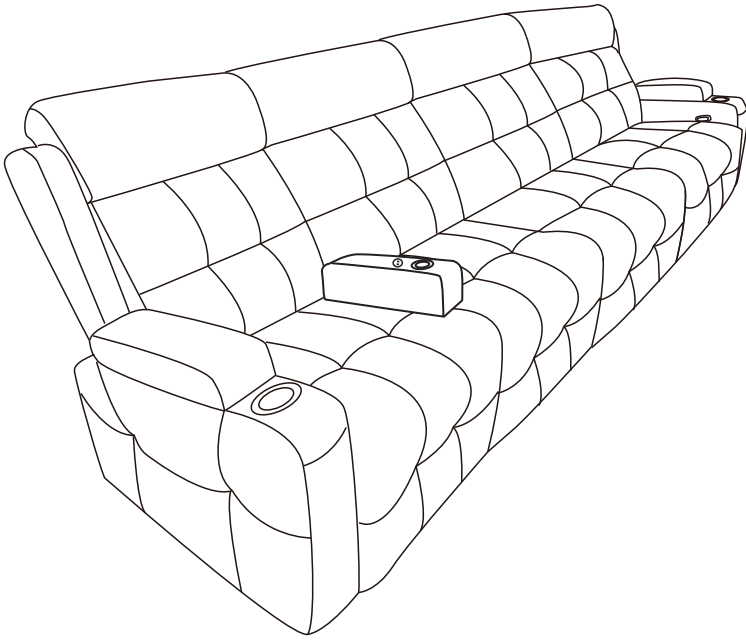

## WARRANTY

- The quality of our products has been strictly controlled. Each stage of the product upgrading has condensed the efforts of employees in various departments. We strive to minimize the probability of failure of new products and insist on providing customers with worry less after-sales service.
- If you have any damage or quality problems after receiving the goods, please contact us in time, our professional after-sales team will reply you as soon as possible and help you solve it.
- In order to save your time, please describe the problem in detail. If possible, we hope you can upload product pictures for our reference, and inform us the part number according to the instructions.

## AFTER-SALE POLICY

In order to better provide after-sales service experience, we provide the following after-sales policies. At the same time, we also hope that you can actively cooperate with us.

- Within the warranty period of the product, In case of product quality problems, you can contact us, we can provide you with parts replacement services, but for functional issues, we hope you could cooperate with us to complete the troubleshooting steps we told you and inform us the result so we could help you solve it.
- For the return problem, we do not accept unreasonable refunds. If you are not satisfied within 3 days after receiving the goods, we hope you can contact us as soon as possible. After we checked, you must return the product in their original status, so you could qualify for a refund.

# After-sales service

What problems did you encounter when using our products

Difficult to install the product

Damage caused by express delivery

Missing Fittings

**No matter What problem you encounter, please keep contact with our professional after-sales team:**

**Email: [SofaService@outlook.com](mailto:SofaService@outlook.com)**

We will give you a perfect solution within 12 hours

## How to contact us on Amazon?

