

# Assembly Instructions

## King Bed

N757P422860/861

### Case & Maintenance



Not for commercial use. For residential use only.



Furniture may scratch floors. We recommend using furniture pads to protect your floors.



Do not put hot items directly on furniture surface.



Do not clean furniture with harsh cleansers or polish.



Do not place furniture under direct sunlight.



Do not write on furniture near heating or cooling vents.



Do not write on furniture without a padded barrier to protect the surface.



Do not place furniture outside for indoor use only



Stains may be removed with mild soap solution and damp cloth.



Children should not climb or jump on the furniture.



Dust and pick-upspills using a clean, non-colored, lint-free cloth.



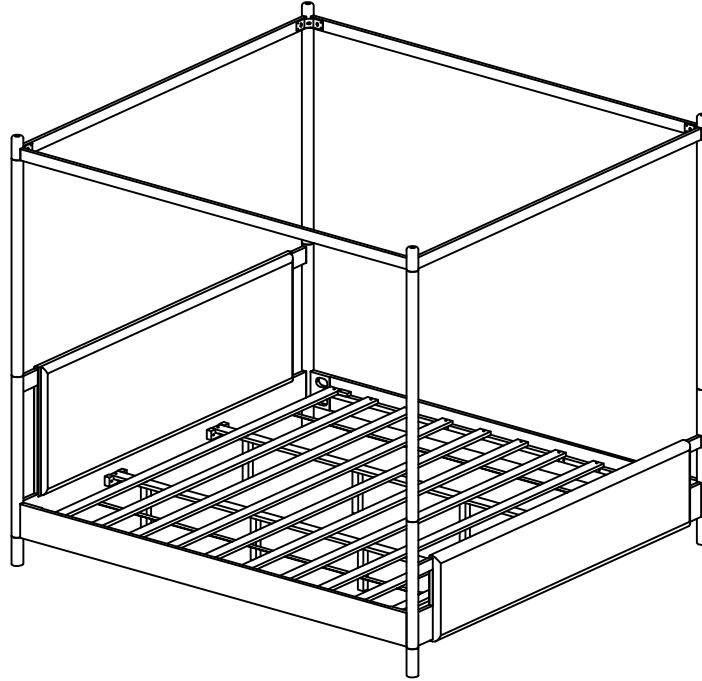

Please look in the box for hardware packs and legs.

Sets oftenship in multiple boxes and may arrive a day or two apart.

King Bed  
N757P422860

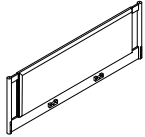
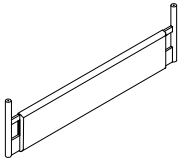
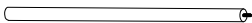
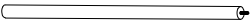

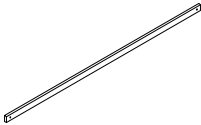
Part List : N757P422860

Label	Picture	Description	QTY
①		Headboard	1
②		Footboard	1
③		Bed Post	2
④		Bed Post	2
⑤		Bed Legs	4
⑥		Upper Cross Side Rail	2
⑦		Threaded Insert	4





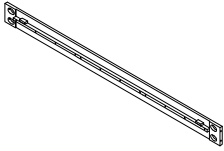
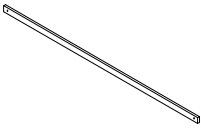
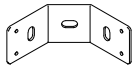
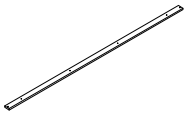
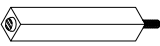
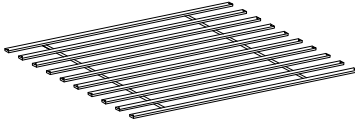

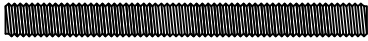
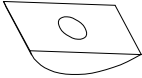

N757P422861

Part List : N757P422861

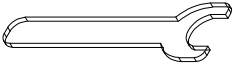
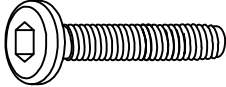
Label	Picture	Description	QTY
⑧		Side Rail	2
⑨		Upper Side Rail	2
⑩		Corner Bracket	4
⑪		Middle Support bar	2
⑫		Center Support Leg	8
⑬		Slats	1

# N757P422860/861

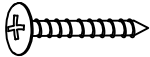
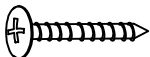







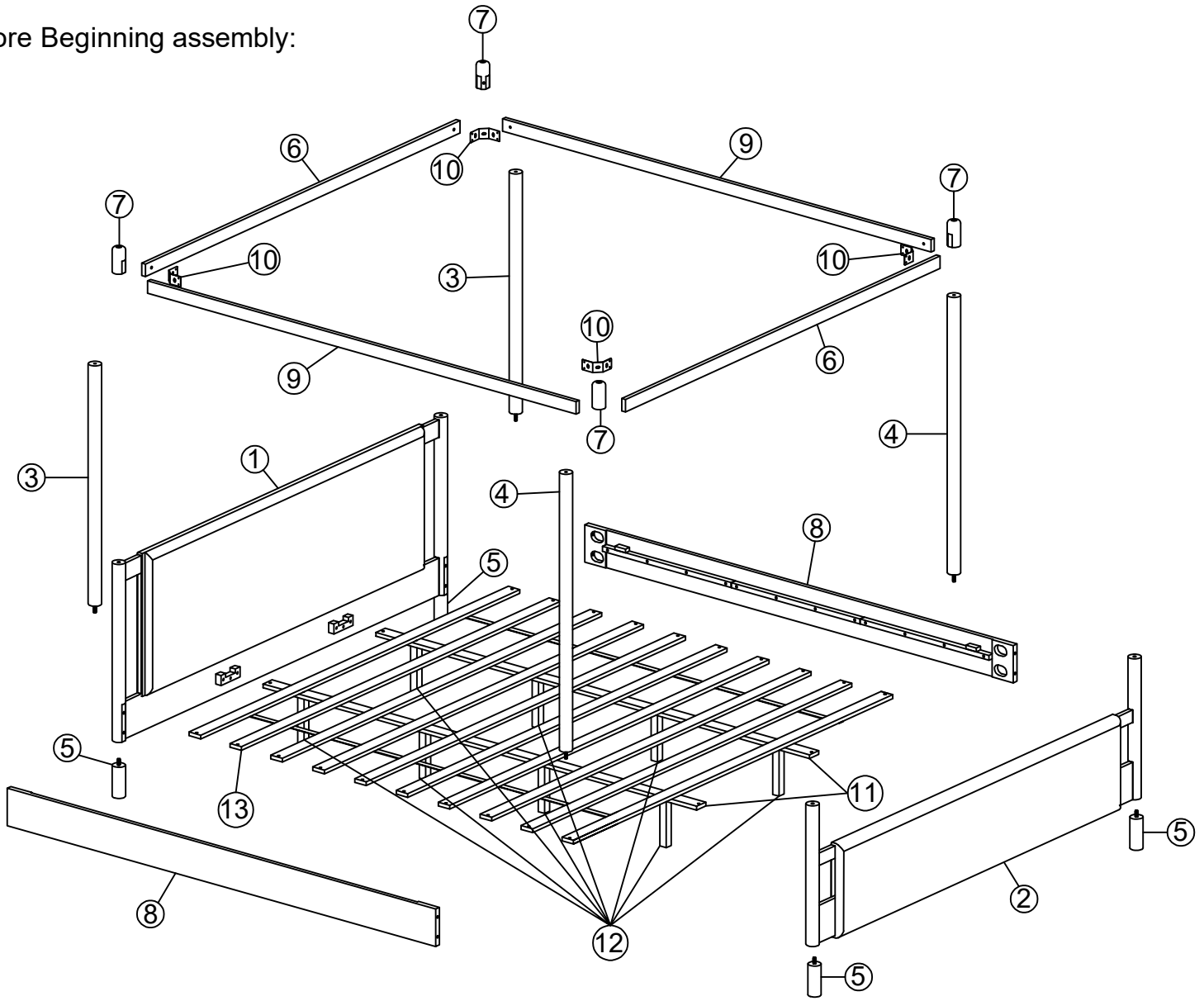

## Hardware

Label	Picture	Description	QTY
<b>A</b>		Bolts(5/16"x80mm)	<b>8+1</b>
<b>B</b>		Curved Washer (5/16")	<b>8+1</b>
<b>C</b>		Flat washer(5/16")	<b>12+1</b>
<b>D</b>		Hex Nut (5/16")	<b>8+1</b>
<b>E</b>		Wrench key	<b>1+1</b>
<b>F</b>		Bolts(1/4"x15mm)	<b>12+1</b>
<b>G</b>		Lock washer(1/4")	<b>12+1</b>
<b>H</b>		Flat washer(1/4")	<b>12+1</b>
<b>T</b>		Bolts(5/16"x100mm)	<b>4+1</b>
<b>K</b>		Lock washer(5/16")	<b>4+1</b>
<b>L</b>		Screw(4x12mm)	<b>16+1</b>
<b>M</b>		Screw(4x25mm)	<b>24+1</b>
<b>N</b>		Allen Key (M4)	<b>1+1</b>

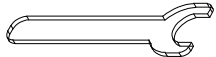

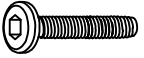

# Assembly Preparation

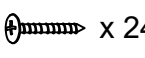
Before Beginning assembly:



<b>(A)</b>  x 8pcs+1	<b>(B)</b>  x 8pcs+1	<b>(C)</b>  x 12pcs+1	<b>(D)</b>  x 8pcs+1
<b>(E)</b>  x 1pcs+1	<b>(F)</b>  x 12pcs+1	<b>(G)</b>  x 12pcs+1	<b>(H)</b>  x 12pcs+1
<b>(T)</b>  x 4pcs+1	<b>(K)</b>  x 4pcs+1	<b>(L)</b>  x 16pcs+1	<b>(M)</b>  x 24pcs+1

<b>(N)</b>  x 1pcs+1
---

-  Read the instructions cover to cover
-  Have 2 adults on hand for assembly
-  Do not assemble on flooring or carpet
-  Assemble on a clean, non-marring surface (packing foam)
-  Save all packaging until finished

# Assembly Steps

## OVERVIEW

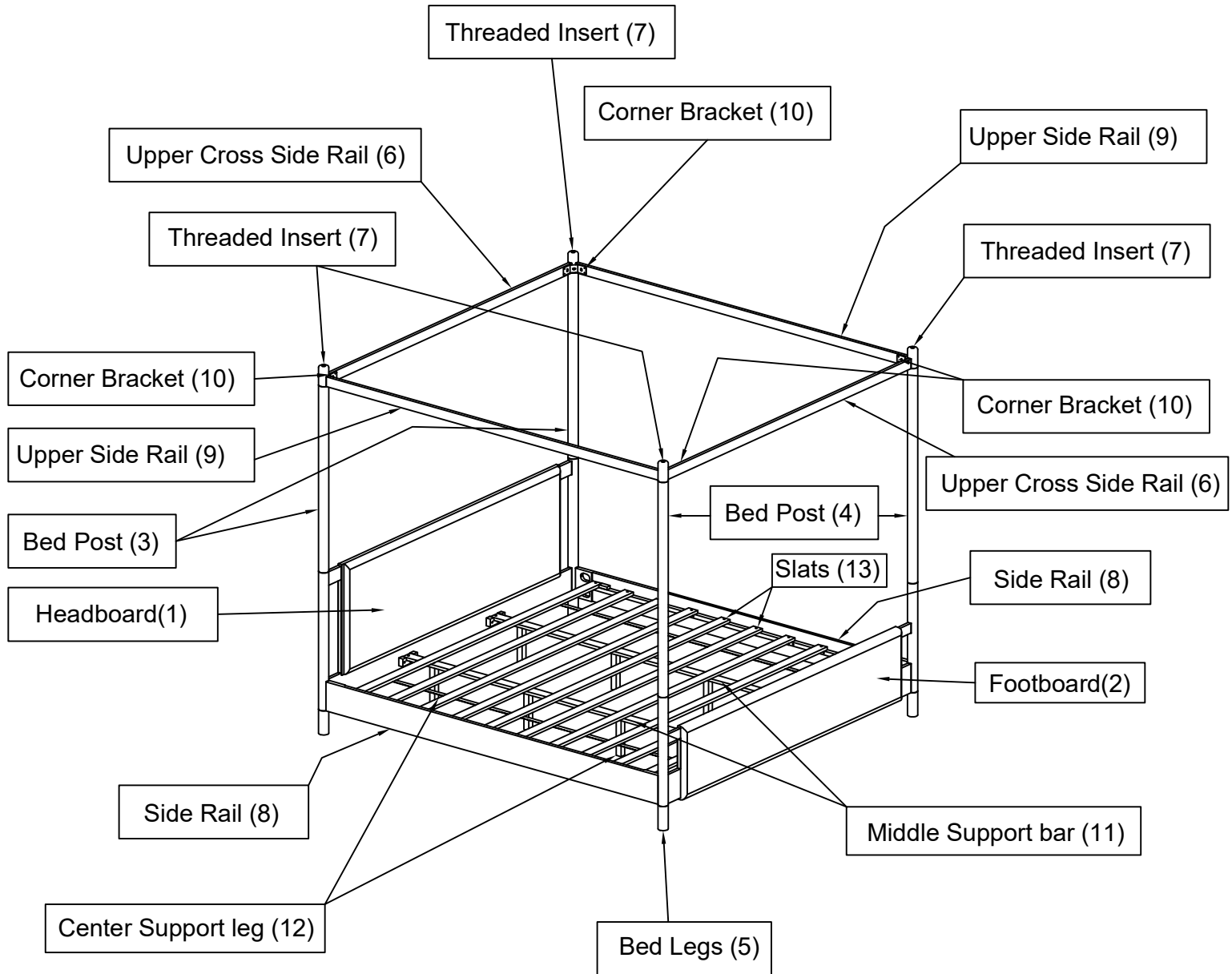

## FRONT FACING

This Bed have multiple parts and may require up to 30 minutes to assemble. To give you an overview of the Bed parts, the above picture is to help you put the various parts into perspective. Please read through the instructions below to familiarise yourself with the parts and steps before assembly.

Note: It is recommended that you have an adult partner to assist during the entire assembly process.

## Step 1

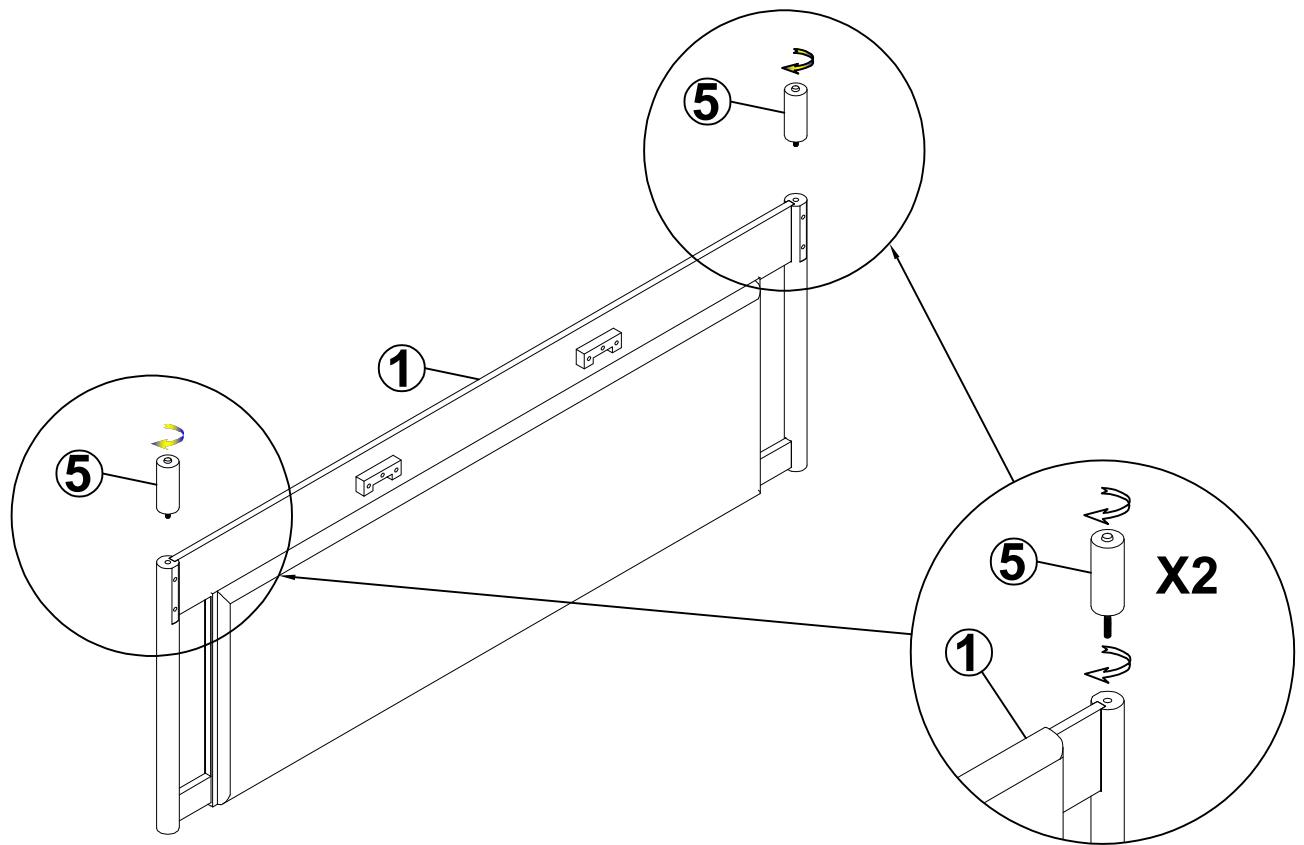

Connect the bed foot (5) with the head of the bed(1)  
(Note : Tighten the bed legs.)

## Step 2

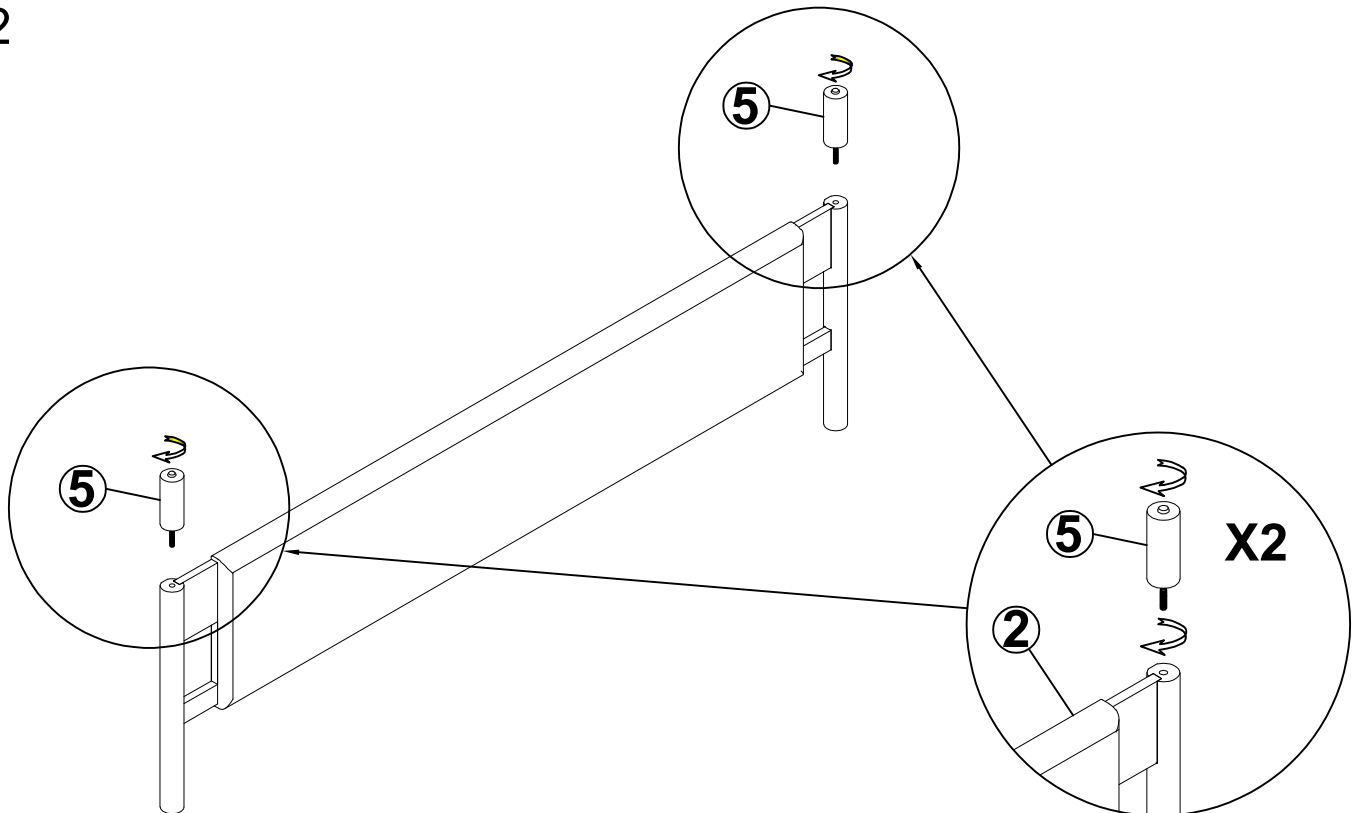

Connect the bed foot (5) with the foot of the bed(2)  
(Note : Tighten the bed legs.)

### Step 3

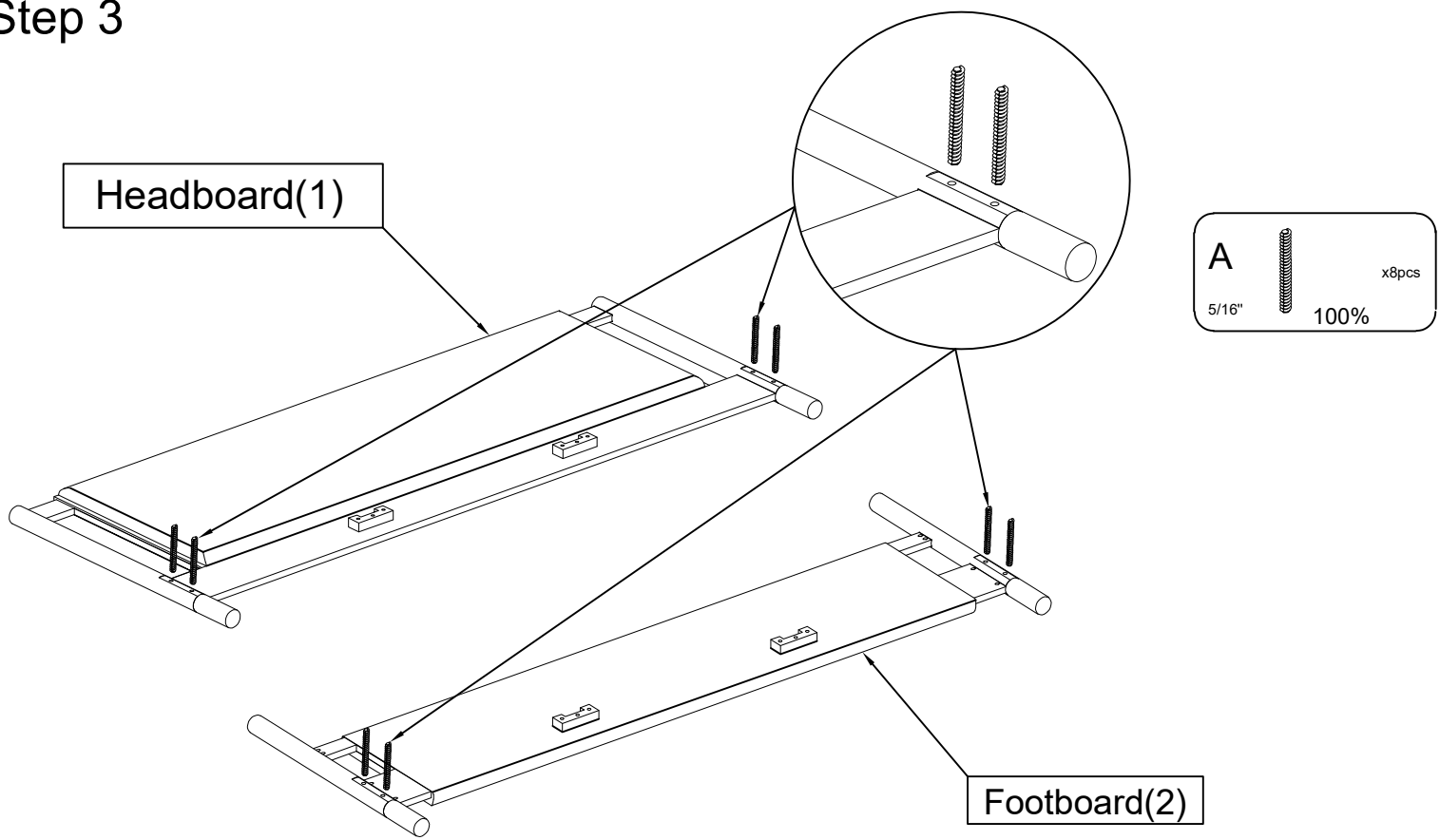

Use the Bolts (A), to connect to the headboard(1) and footboard(2)



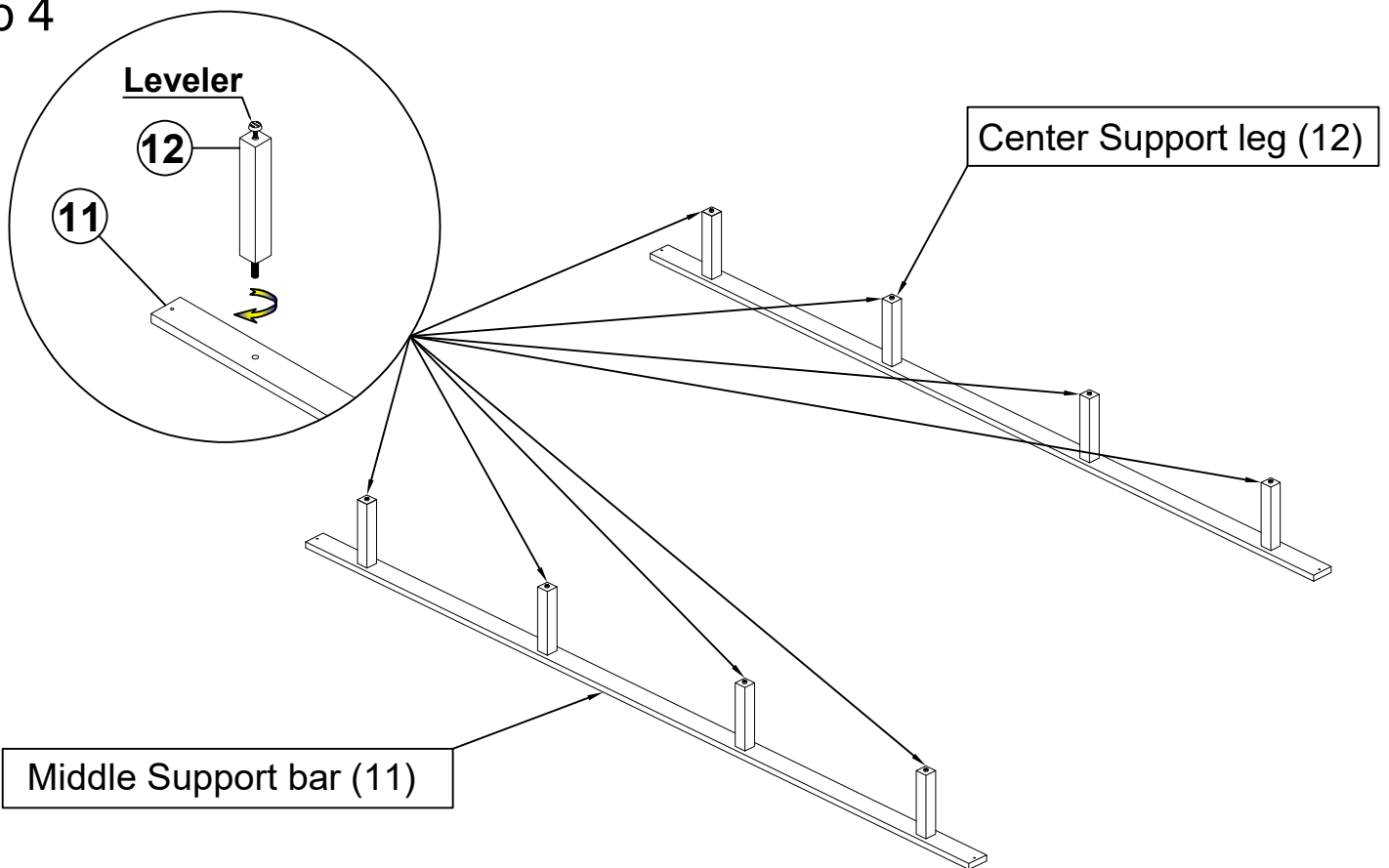

### Step 4

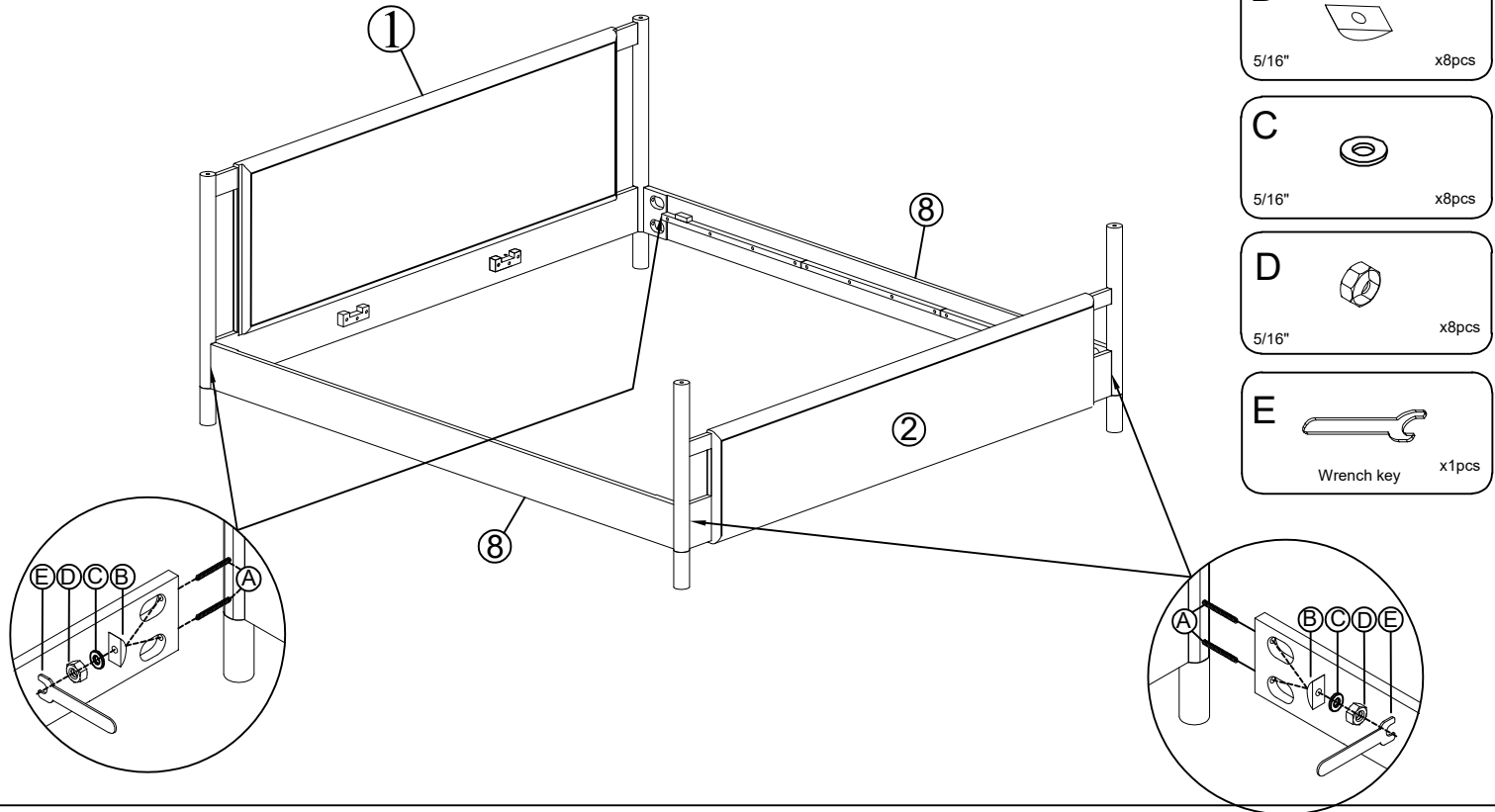

Use the Center Support (12), to connect to the Middle Support bar (11).

# Step 5



- B**  5/16" x8pcs
- C**  5/16" x8pcs
- D**  5/16" x8pcs
- E**  Wrench key x1pcs

Attach the Side Rail (8) to the Headboard (1) and footboard (2).  
by using Curved washer (B) and Flat washer (C) Hex Nut (D). Then use Wrench Key (E) to tighten the Hex Nut (D)

# Step 6

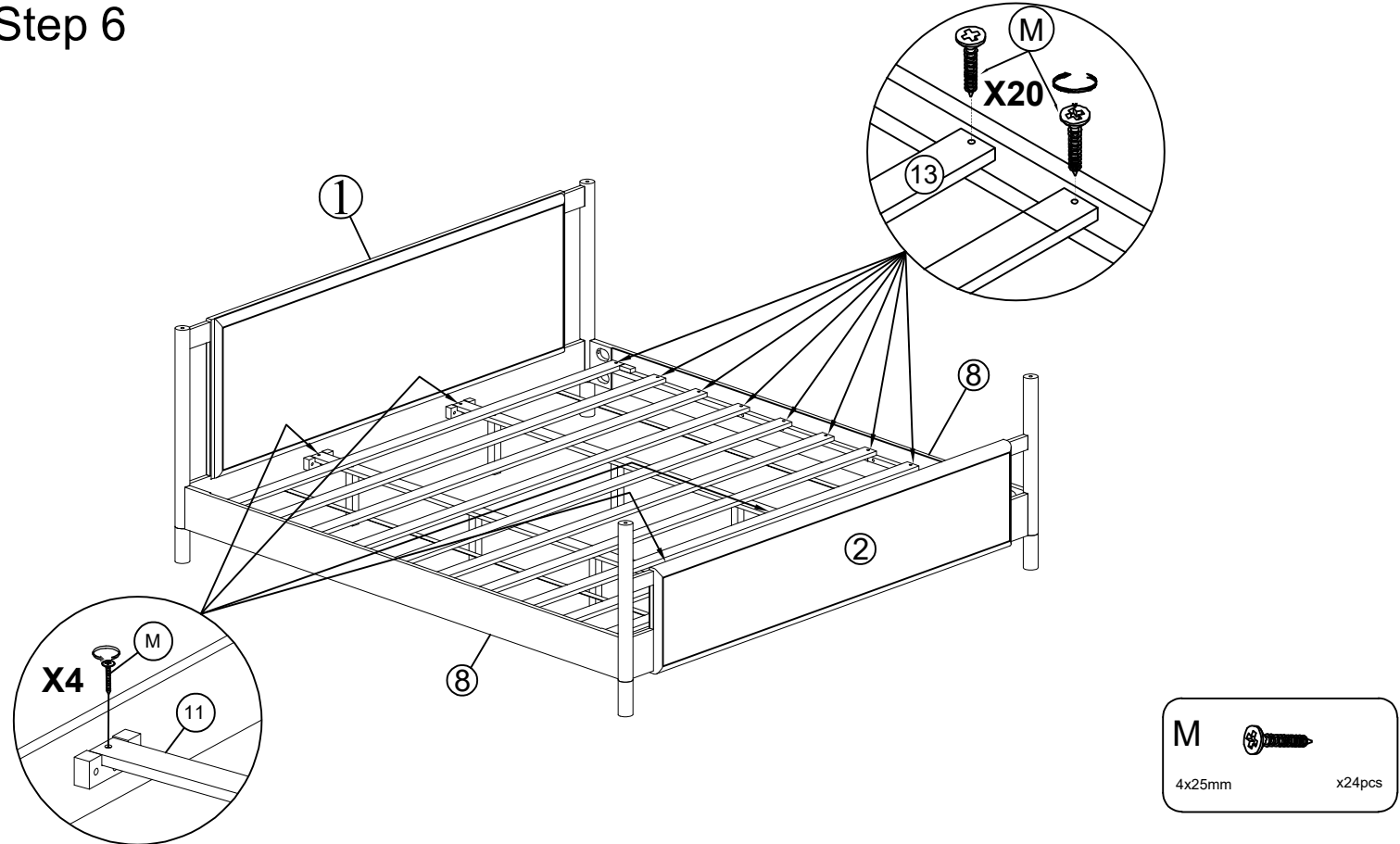

- M**  4x25mm x24pcs

Assemble the Middle Support bar (11) to the Headboard (1) and footboard (2). Use Screw (M)  
Assemble the Slats (13) to the bed Sides Rail (8). Use Screw (M)

# Step 7

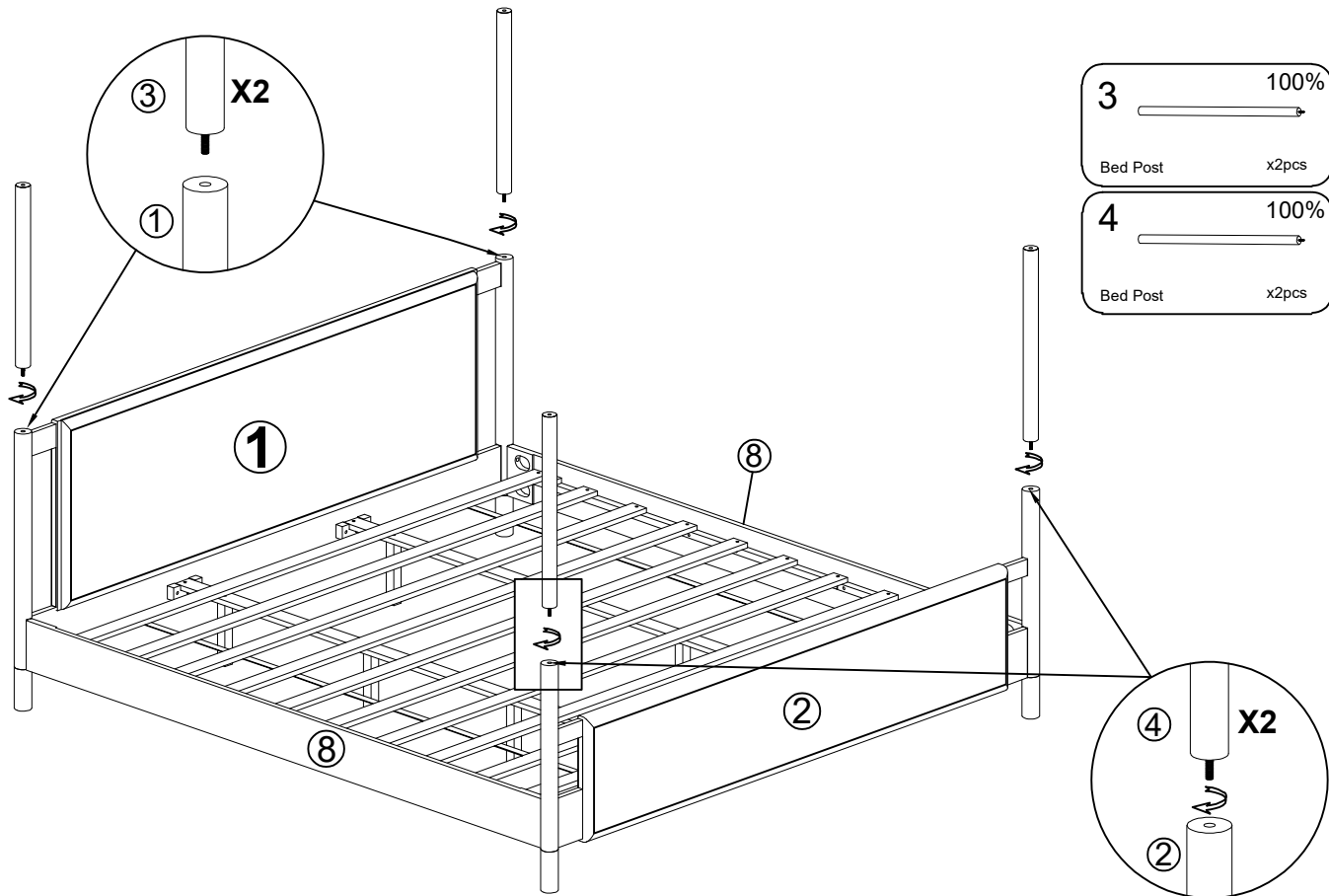

Attach the Bed Post (3) to the Headboard (1) and the Bed Post (4) footboard (2). Tighten.

# Step 8

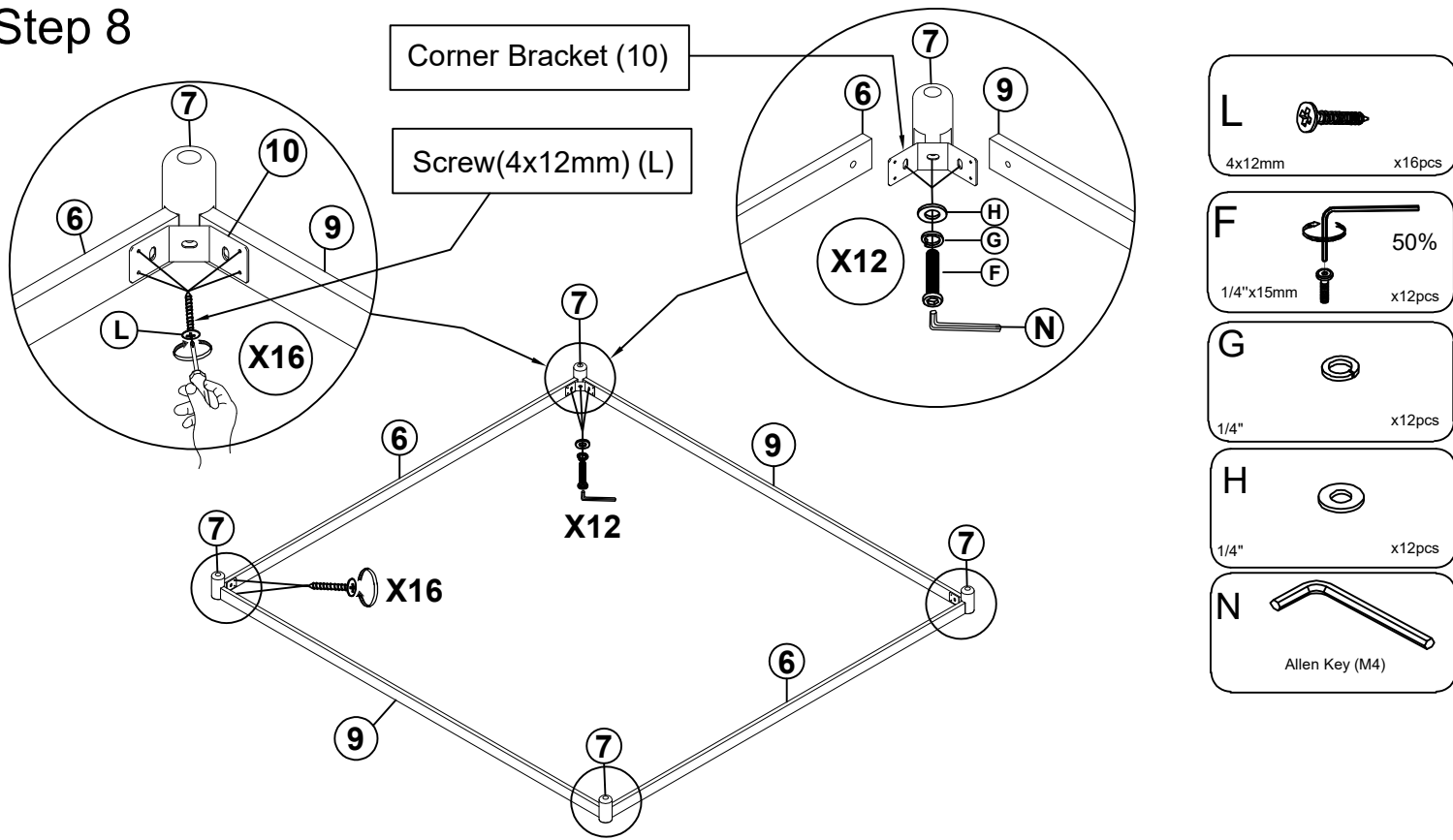

Attach the Corner Bracket (10) assemble with Threaded Insert (7) Upper Cross Side rail (6) and Upper Side Rail (9) Use Bolts (F) and Lock Washer (G) with Flat Washer (H). Then Use with Allen Key (N) Tighten

Use the Screw (L) Tighten Corner Bracket (7) with Threaded Insert Upper Cross Side rail (6) and Upper Side (9)

# Step 9

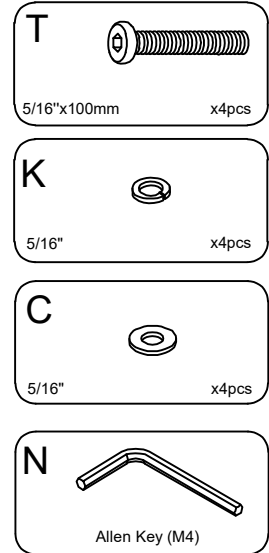
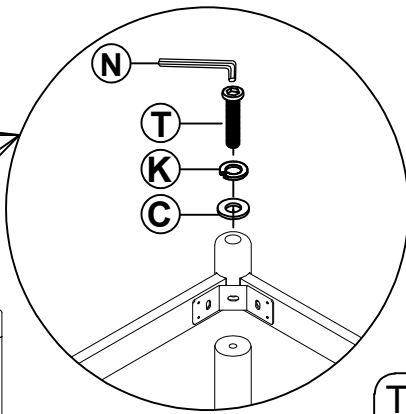
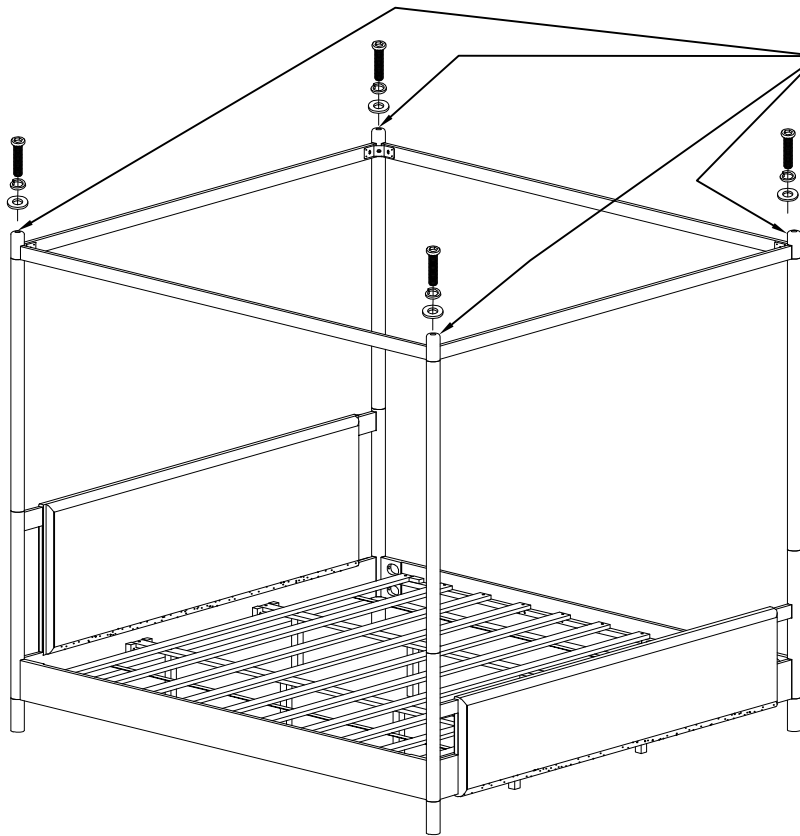

Use the Bolts (T), Lock washer (K) and Flat washer (C) to connect the Headboard (1) and the footboard (2) then tighten with Allen Key (N).

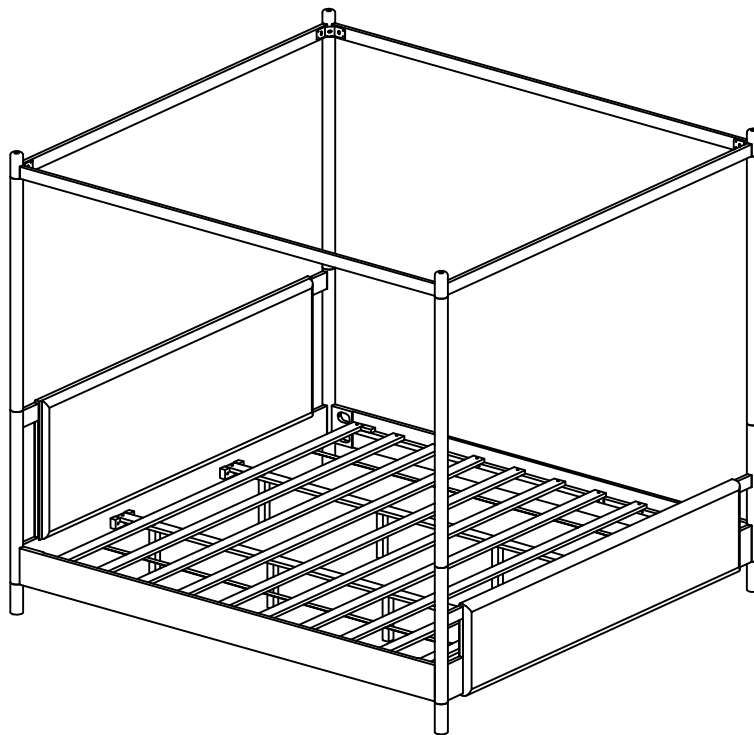

Thank you for your trust and preference in using our products.  
The product will bring you a peaceful sleep forever

## Finish

Place the Bed on a LEVEL SURFACE.

Inspect it and make sure all parts are adequately connected.

Don't push too hard,shake on the bed.

This would help to align all the parts at the joint areas.

**CAUTION 1:** When tightening these screws, tighten sequentially.

**DO NOT** tighten any screws fully and then towards the next one.

This would cause the frame to warp.

If there is still wobbles, loosen the screws and execute this same process.**DO NOT** tighten any screws fully and then towards the next one.

**WARNING!! IF BED IS NOT STABLE, IT COULD LEAD TO DAMAGING THE PRODUCT.**

Ensure all screws are fully locked into position.

The bed is ready to be used.

**Caution 2:** This bed can only be used on a flat,level surface.