

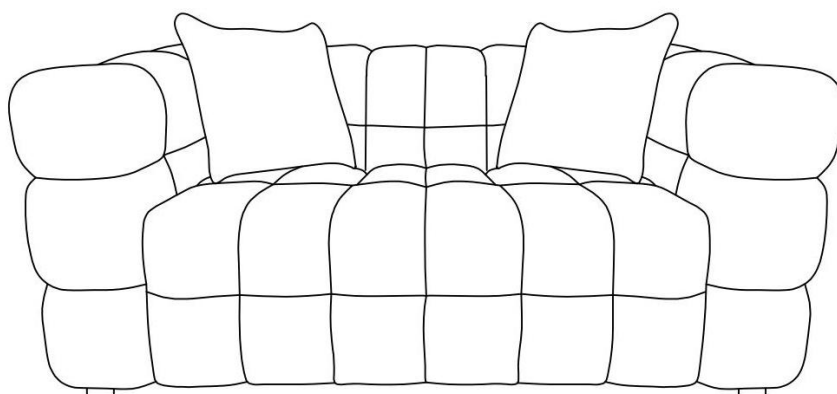



ASSEMBLY INSTRUCTION

LOVESEAT

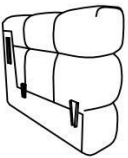
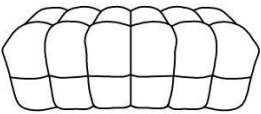
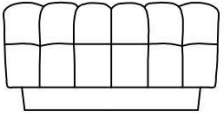

PART LIST

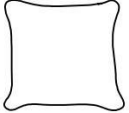
No.	Picture	Description	QTY
AL		Left Armrest	1
AR		Right Armrest	1
B		Seat	1
C		Backrest	1
D		Leg	4
E		Pillow	2

Assembly Preparation

Before Beginning
Assembly:

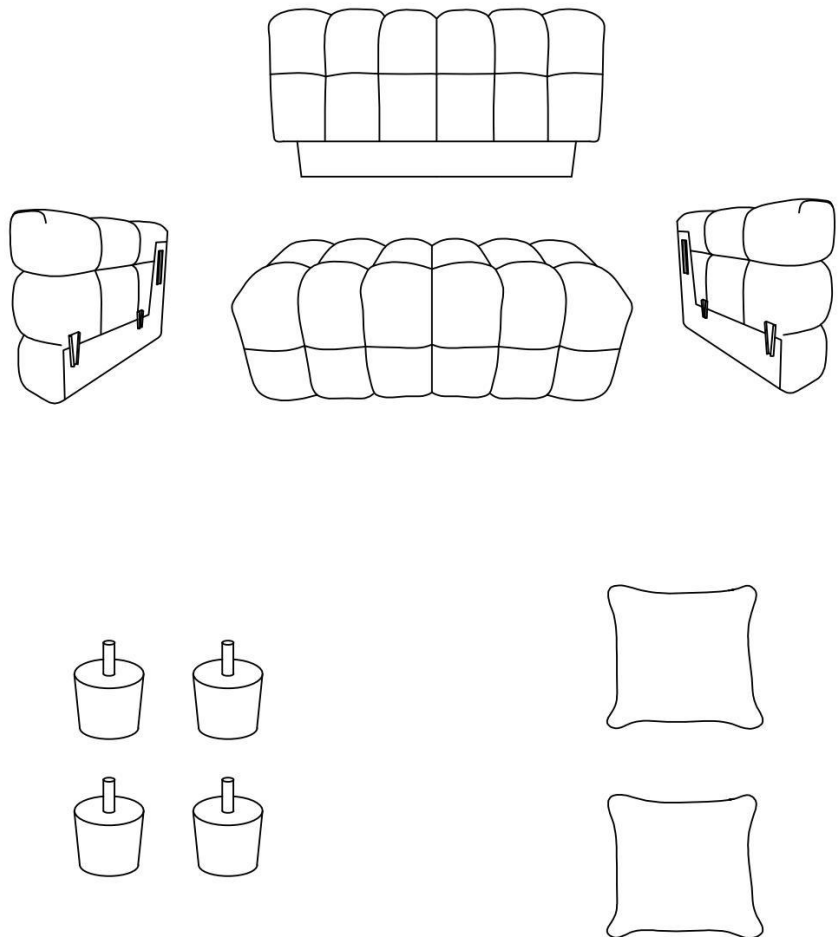

• Read instructions, cover to cover.



• Have 2 adults on hand for assembly.



• Do not assemble on flooring or carpet.



• Assemble on a clean non-marring surface (packing foam).



• Save all packaging until finished.

Step1

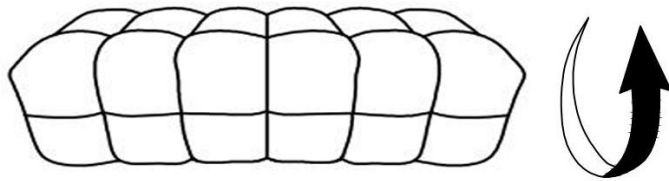

Turn the Seat over to face the bottom.

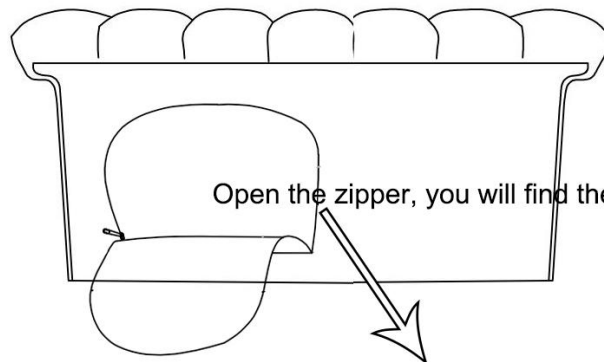

Open the zipper, you will find the sofa legs and pillows.

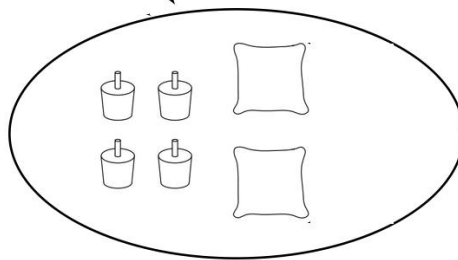

Step2

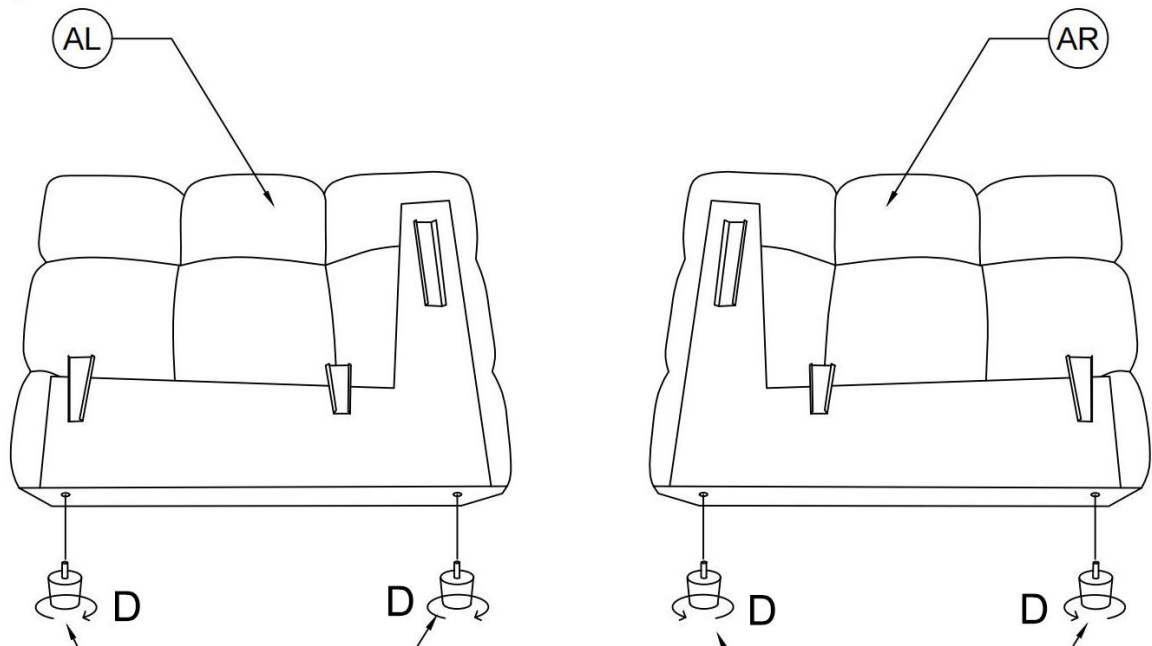

Rotate and screw the sofa feet into the pre-built screw holes in the armrests.

Step3

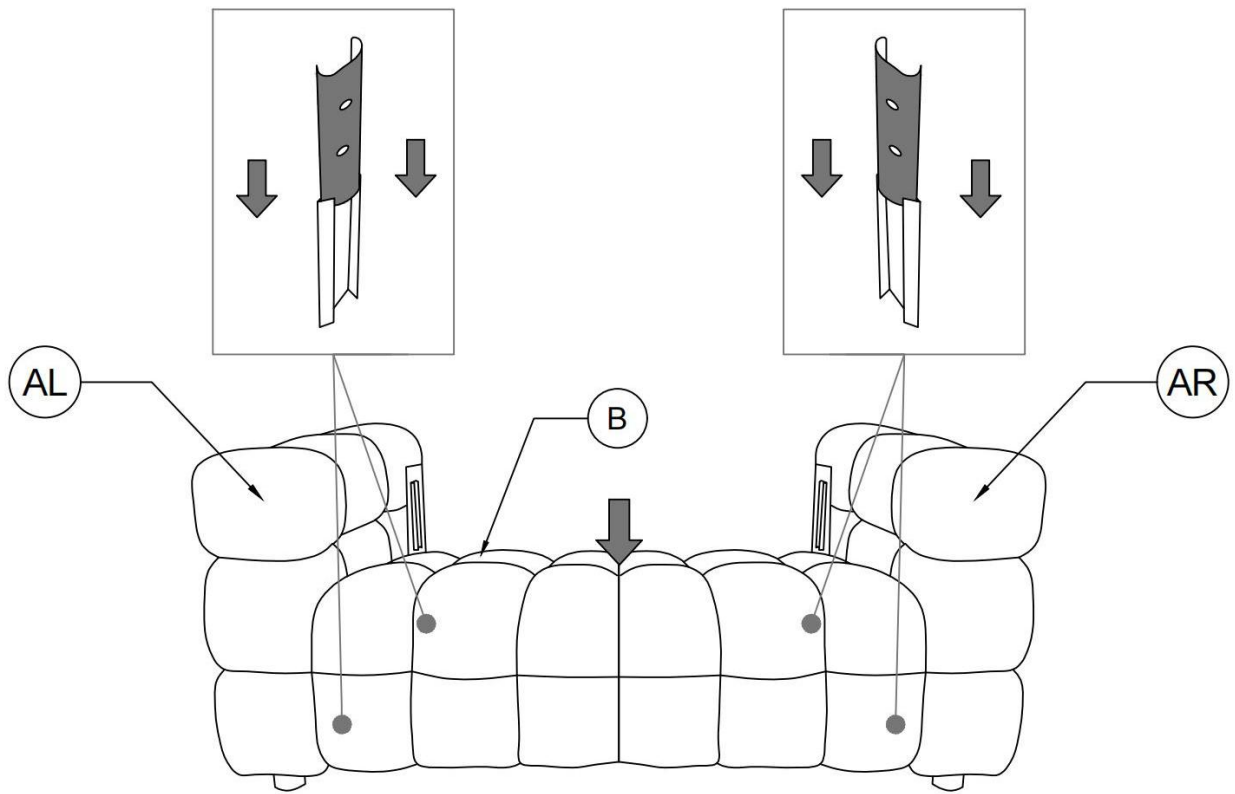

Step4

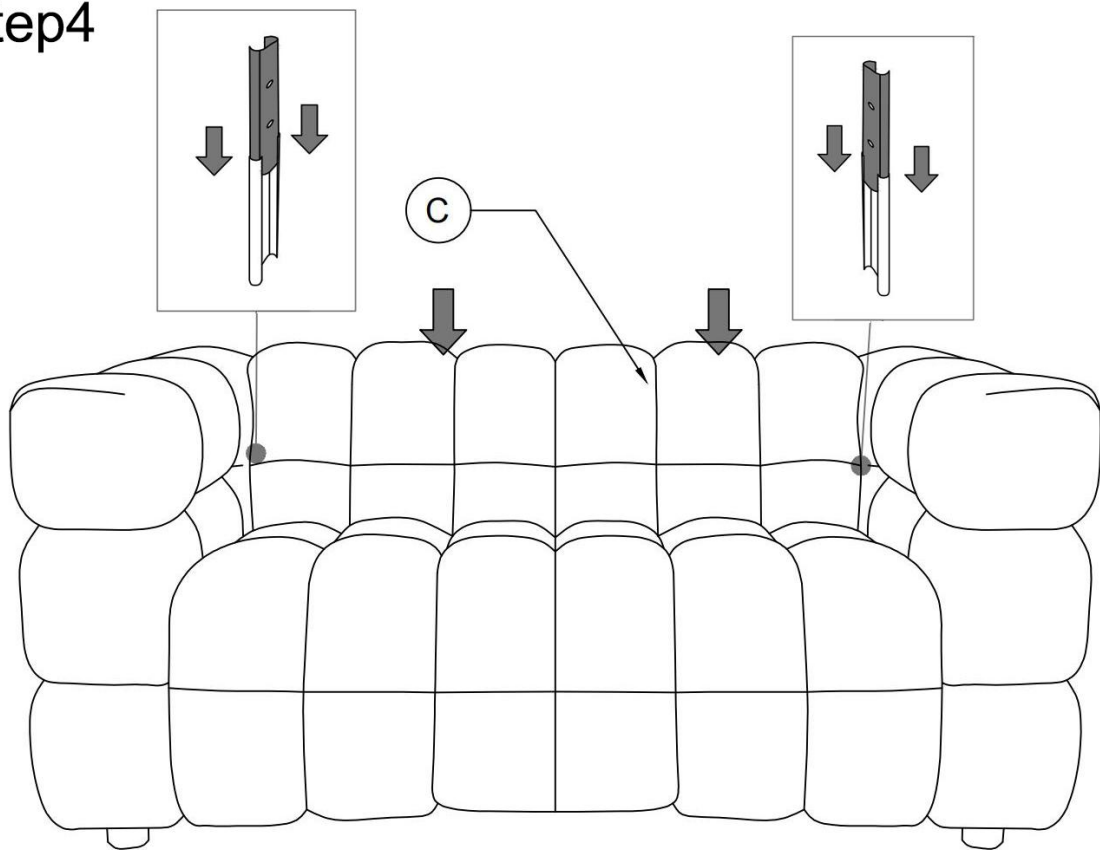

Step5

