

# ASSEMBLY INSTRUCTIONS

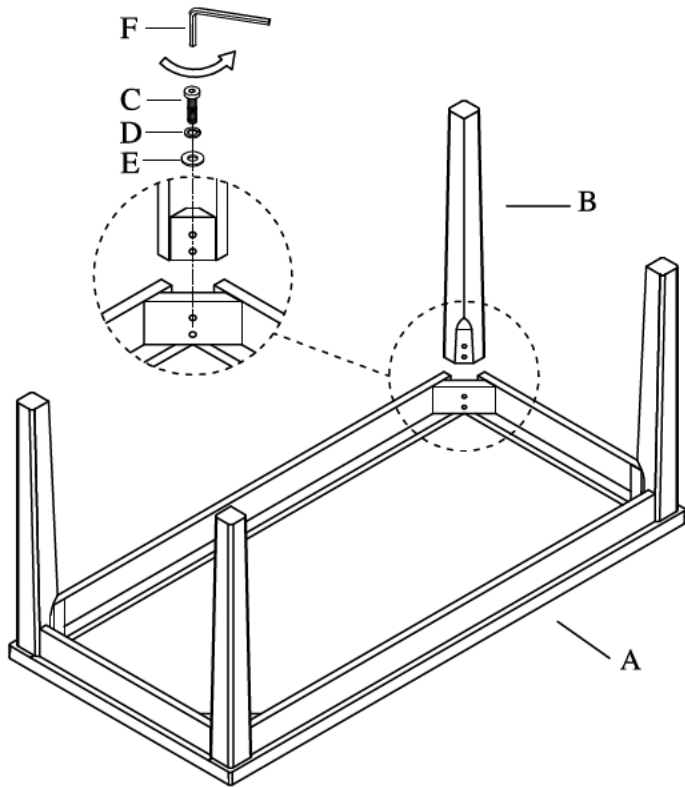

Thank you for purchasing this quality product .Be sure to check all packing material carefully for small parts that may have come loose inside the carton during shipment.

Step 1:Please follow chart to assembly table leg B and table top A,But don't tinghamten the long blot.





**TOOLS REQUIRED(NOT PROVIDED):**  
**PHILLIPS SCREWDRIVER** 





**PARTS LIST:**

NO.	Description	Sketch	Quantity
A	Top		1PC
B	Leg		4PCS

**PARTS LIST:**

NO.	Description	Sketch	Quantity
A	Top		2PCS
B	Leg		8PCS

**HARDWARE LIST:**

NO.	Description	Sketch	Size	Quantity
C	Long Blot		φ1/4"*2"L	24 PCS
D	Lock Washer		φ1/4"	24 PCS
E	Spring Washer		φ1/4"	24 PCS
F	Allen Key		4mm	1PC

NOTE: Straight Allen Key(k)is for use with a power drill.

