

Outdoor Storage Shed 10X14 ft Manual

Dear customer,

Thank you for your support. If you have any questions or concerns, please don't hesitate to contact us. Our customer service team is always here to help and assist you in any way we can. Thank you again for choosing our chicken coop.

Street: 8 The Green Suite A

City: Dover State: DE

Post code: 19901

Phone: 3022415039/
6605538327

Email: easyhelpservice@yahoo.com

Scan the code on your phone and
contact us via email.



sannwsg.com

After-sales phone service hours:

US Central Time: 19:00-23:00

Seattle time: 17:00-21:00





US Eastern Time: 20:00-00:00

Toronto time: 20:00-00:00



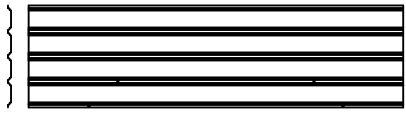

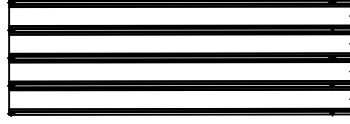

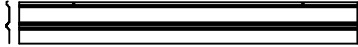
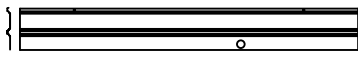













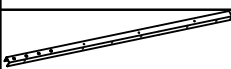

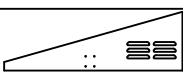

Germany time: 8:00-11:00











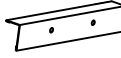

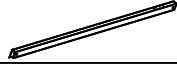

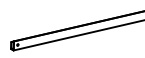





After-sales mailbox service time:
7*24 hours

K1014parts list(A)

PART	NO.	QTY.
	W5-D	25
	W5-KD	2
	W3-D	2
	K1014-7L	2
	K1014-7M	8
	K1014-7R	2
	K1014-7MM	2
	W2-HLD	1
	W2-HRD	1

K1014parts list(B)

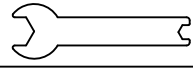
PART	NO.	QTY.
	W5-CD	4
	K1014-7MM	14
	K810-1	2
	K810-1R	2
	K1014-2L	2
	K1014-2R	2
	K1014-2M	2
	K810-3L	2
	K810-3	2
	K1014-4L	2
	K1014-4R	2
	K1014-4M	2
	K1014-5L	2
	K1014-5R	2
	K1014-6L	6
	K1014-6R	6
	K1014-6M	6
	K810-8	4
	K1014-9L	2
	K1014-9R	2
	K1014-9M	2
	K1014-10	2
	K1014-10M	1
	UAD	2

PART	NO.	QTY.
	C3	4
	K1012-11	8
	DAD	2
	DLAD	1
	DRAD	1
	DDA	4
	DBD	4
	GC	4
	GE	2
	T-F	4
	DC	2
	C2	4
	DH	4
	F1	608
	F2	104
	F3	32
	V2	238
	F4	4
	GL	1
	SL	112
	M20	1
	ST	2

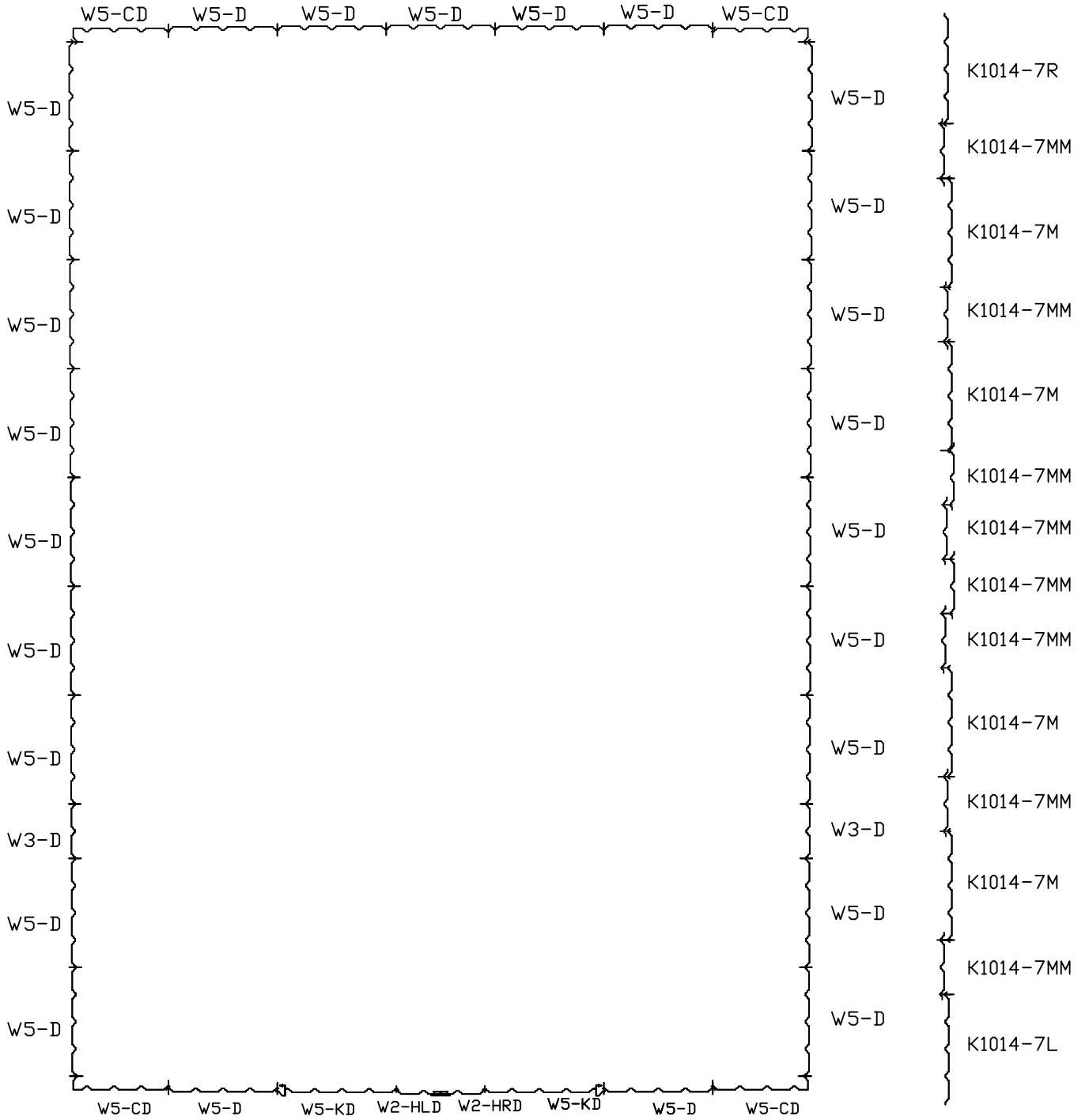

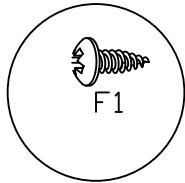



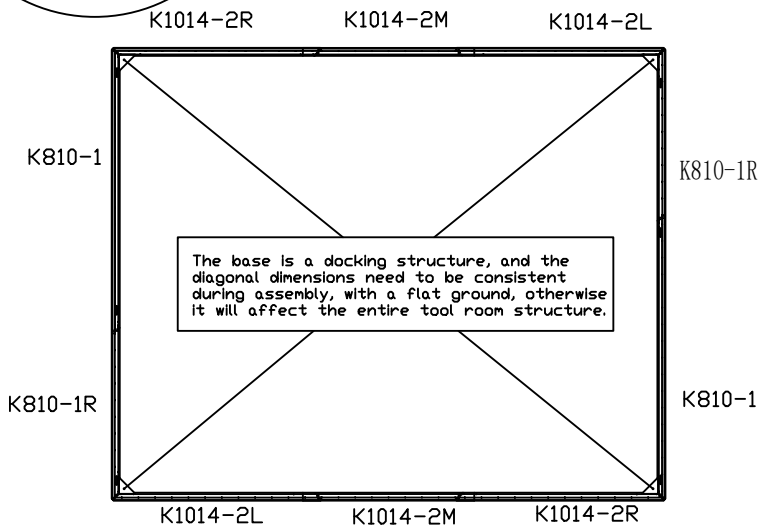
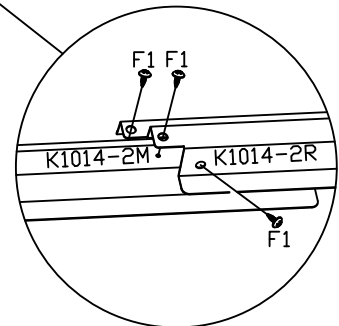
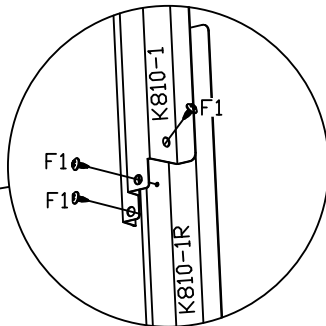
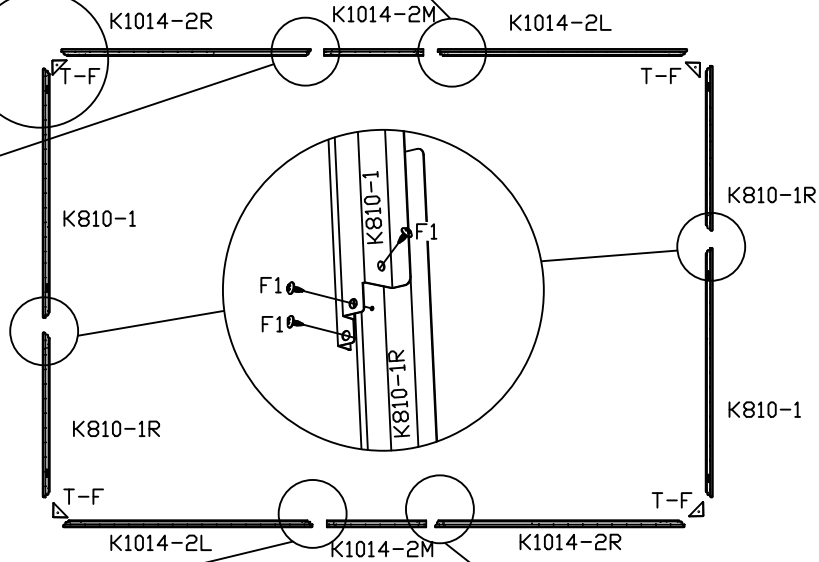
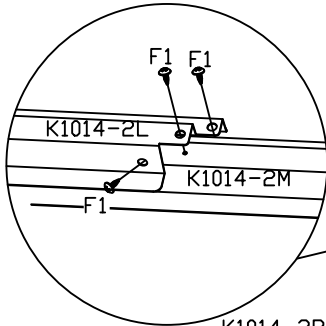
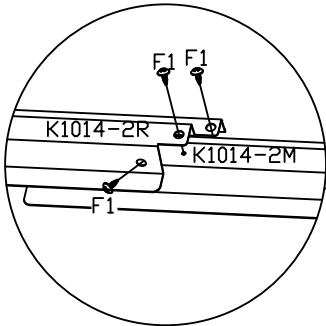
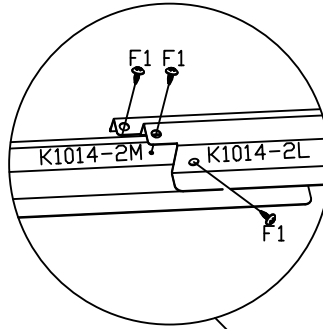
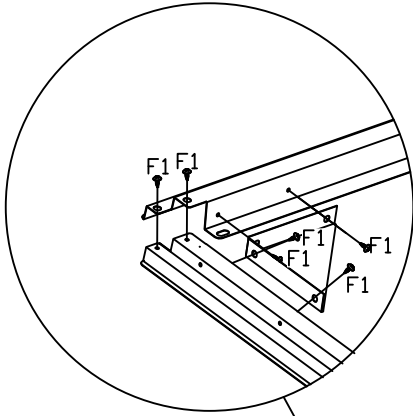

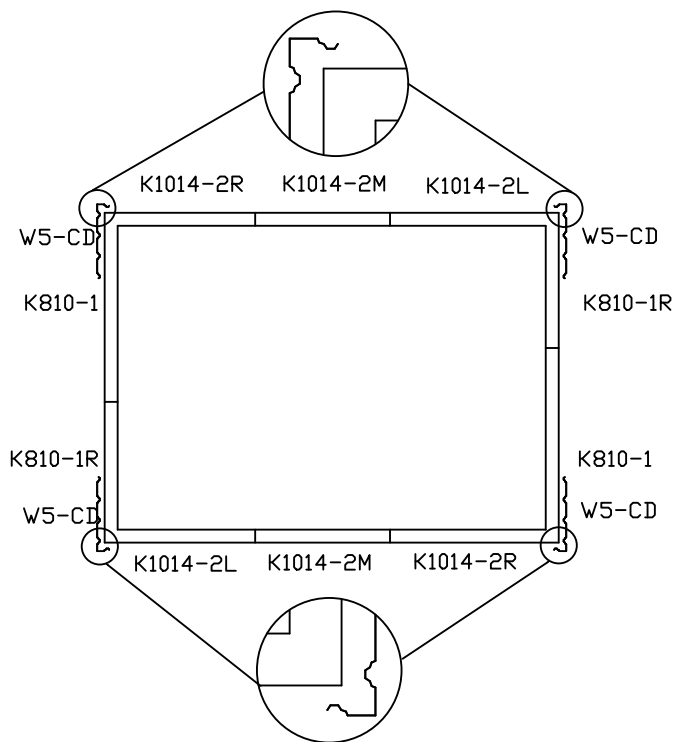

PART	NO.	QTY.
	K1014-2L	2
	K1014-2M	2
	K1014-2R	2
	K810-1	2
	K810-1R	2
	T-F	4
	F1	42



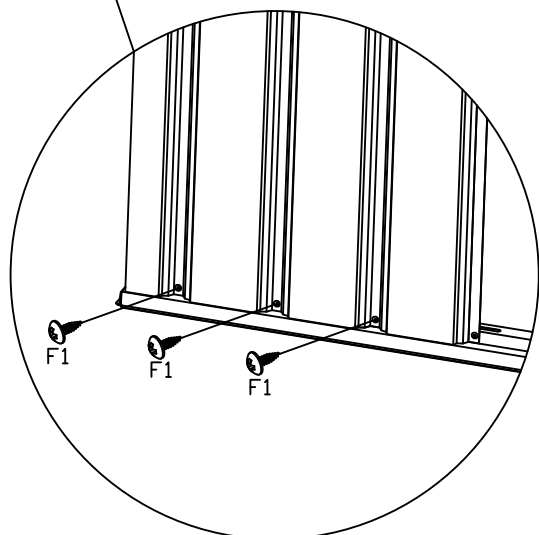
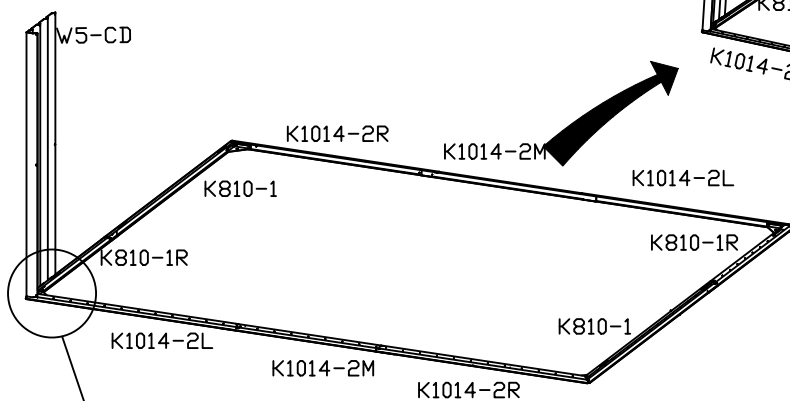
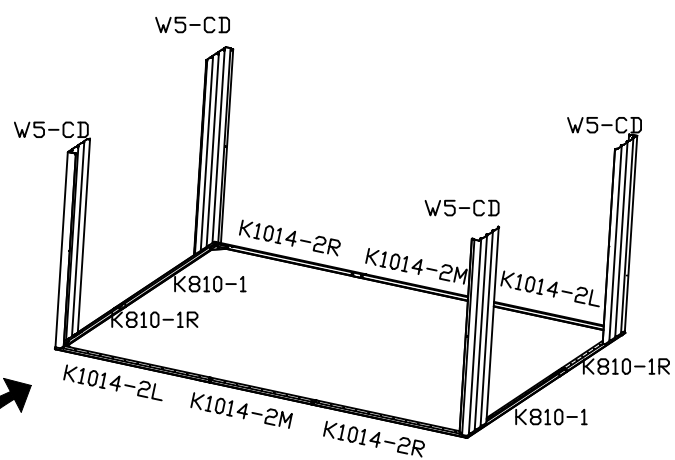





PART	NO.	QTY.
	W5-CD	4
	F1	12

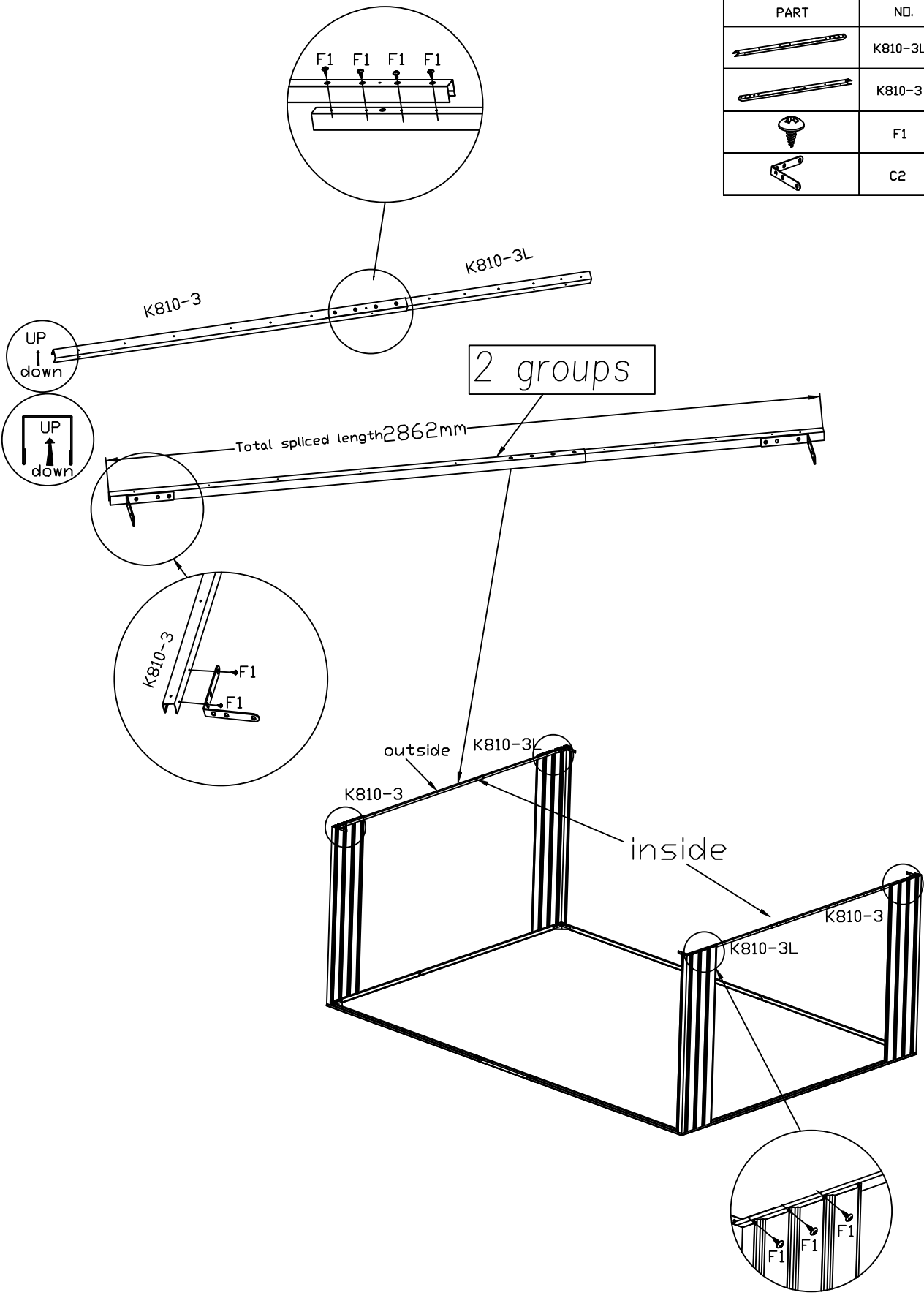





PART	NO.	QTY.
	K810-3L	2
	K810-3	2
	F1	28
	C2	4

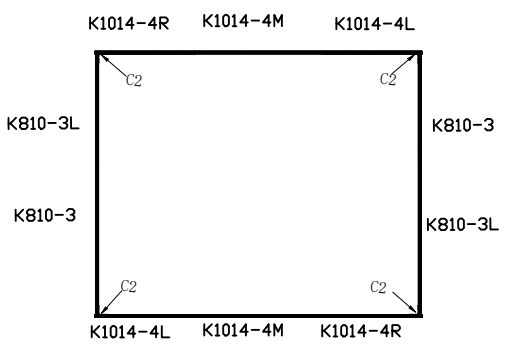
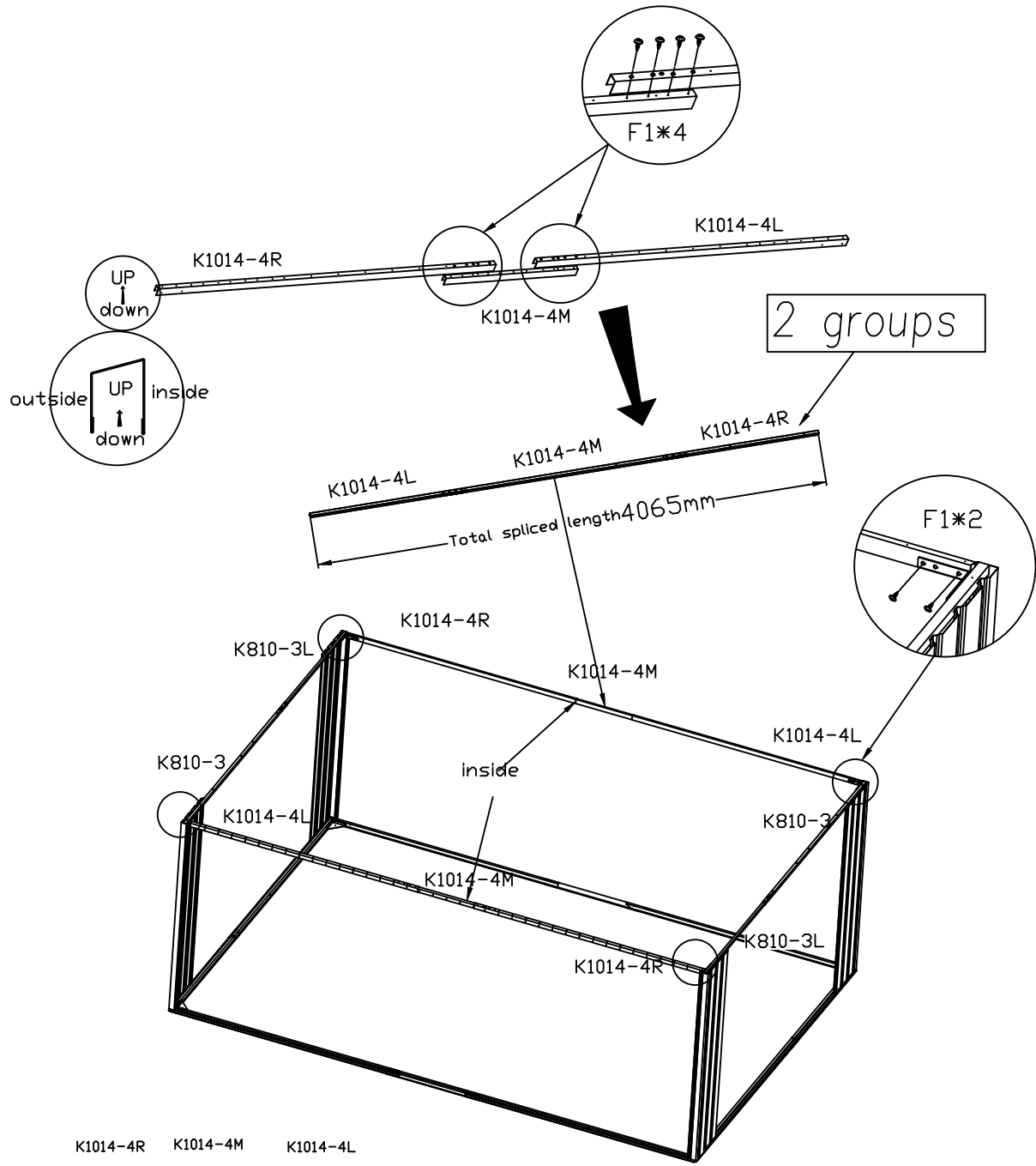

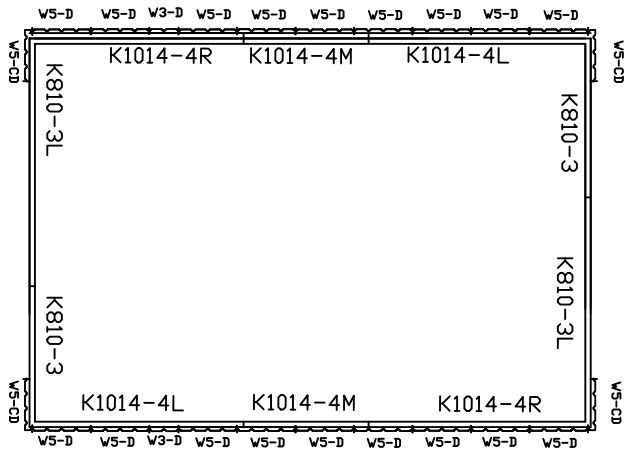
PART	NO.	QTY.
	K1014-4M	2
	K1014-4L	2
	K1014-4R	2
	F1	24





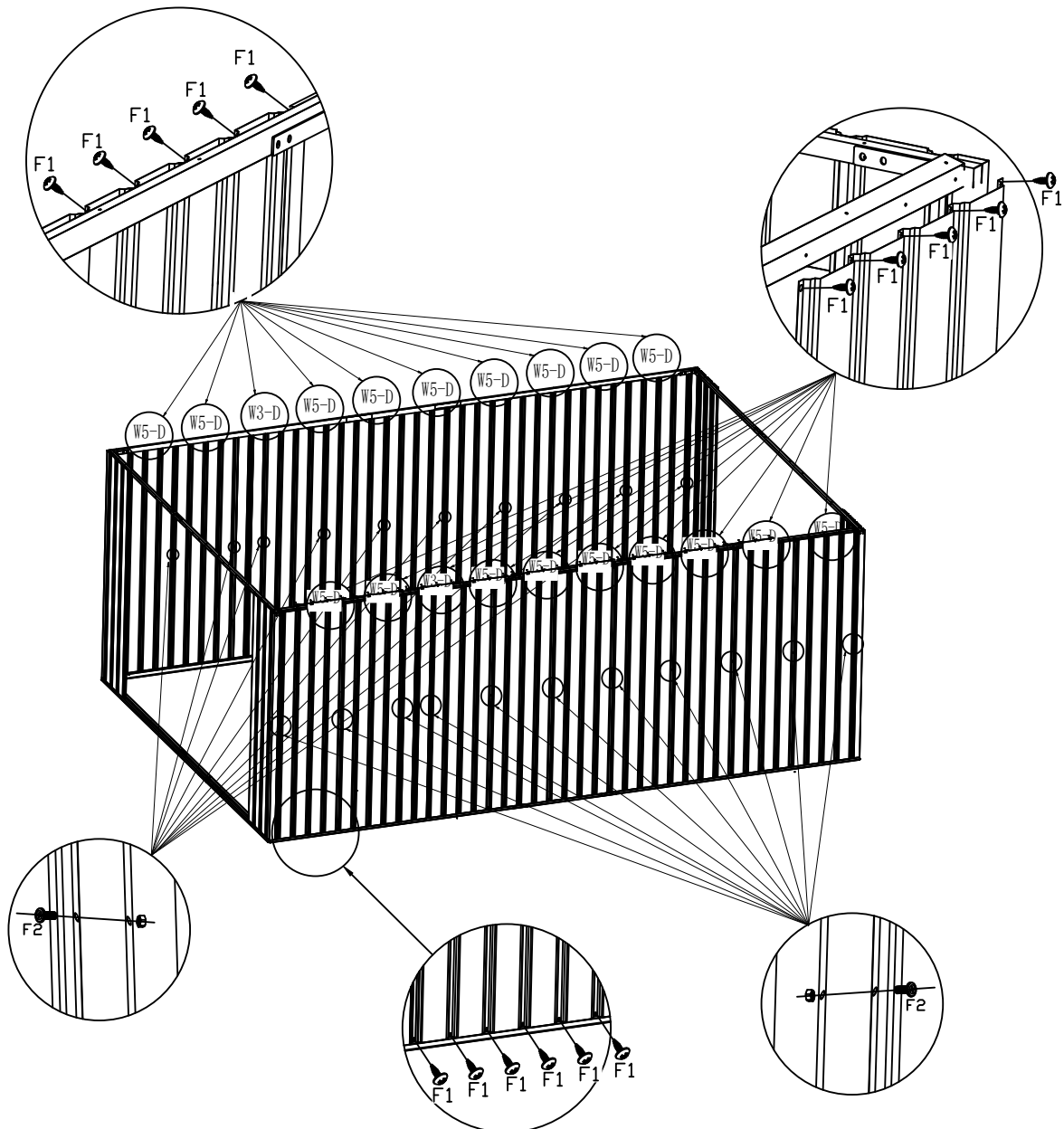

PART	NO.	QTY.
	W5-D	18
	W3-D	2
	F1	156
	F2	22

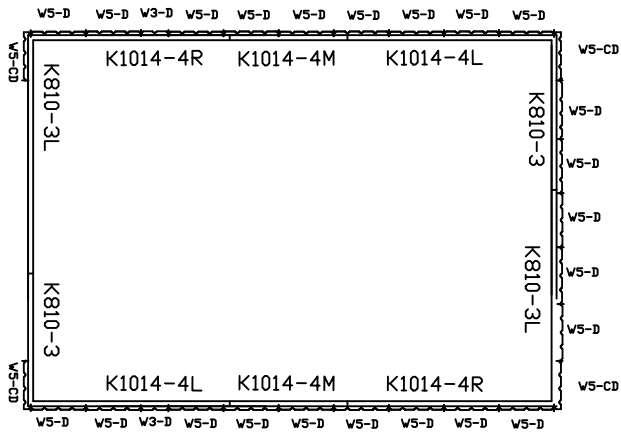



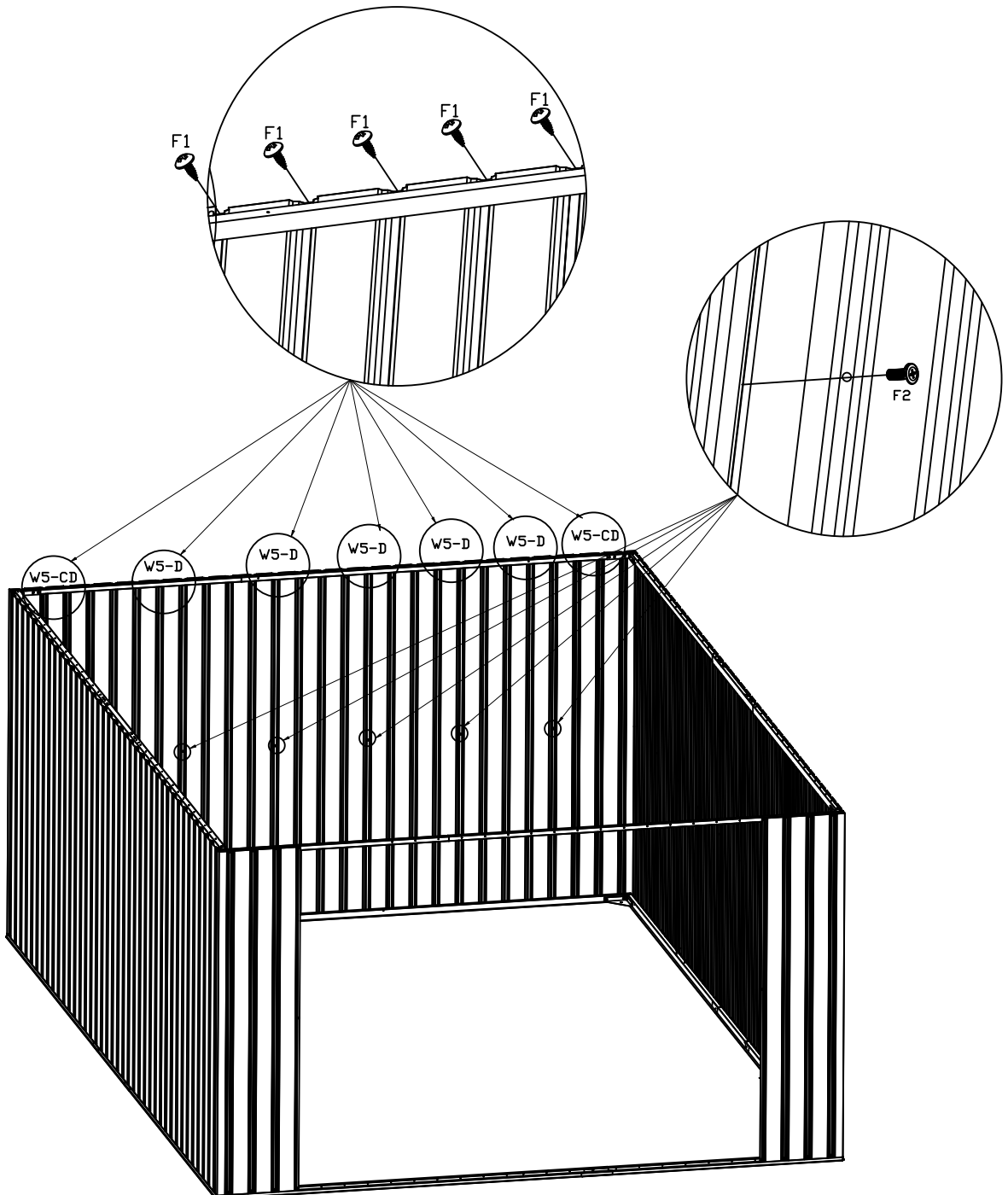

PART	NO.	QTY.
	W5-D	5
	F1	42
	F2	6

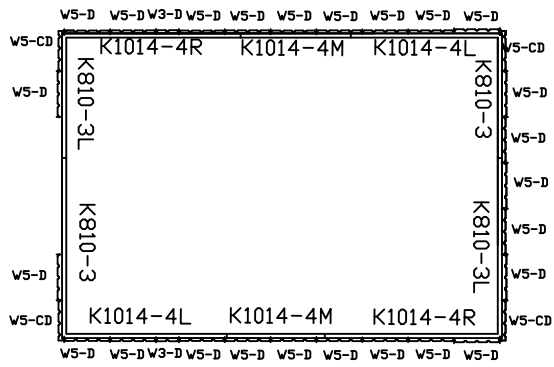





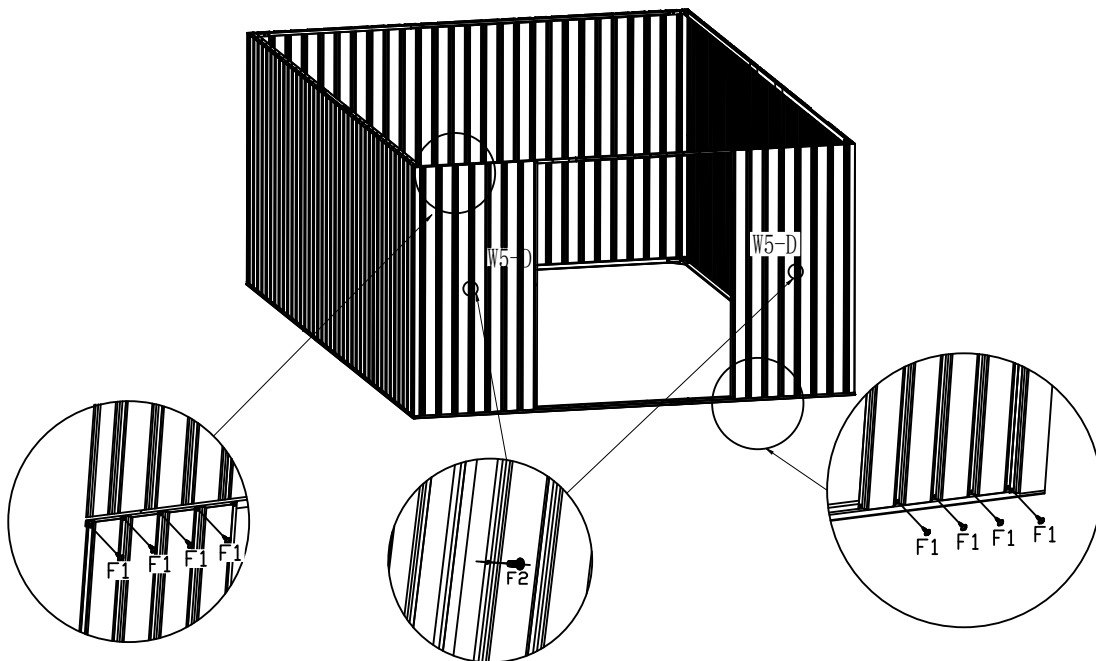

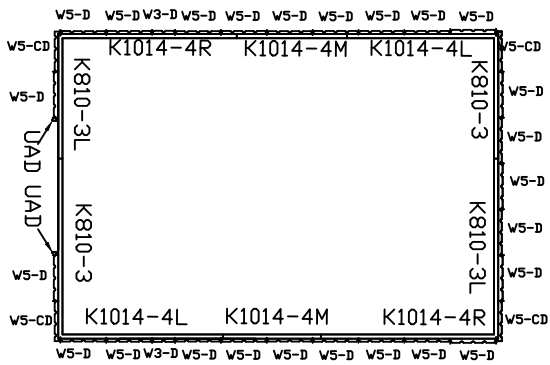
PART	NO.	QTY.
	W5-D	2
	F1	16
	F2	2





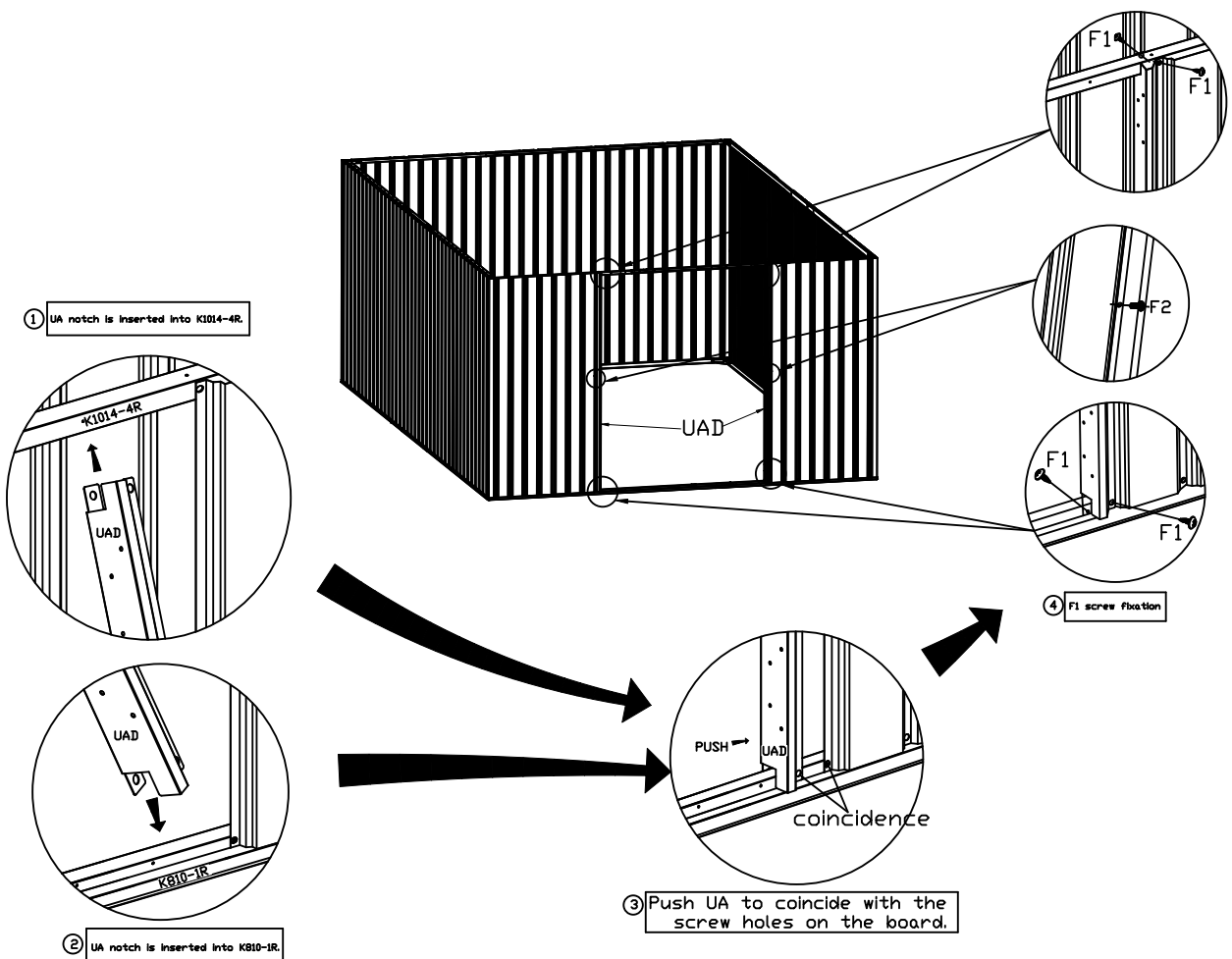

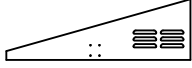
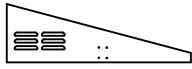
PART	NO.	QTY.
	UAD	2
	F1	8
	F2	2



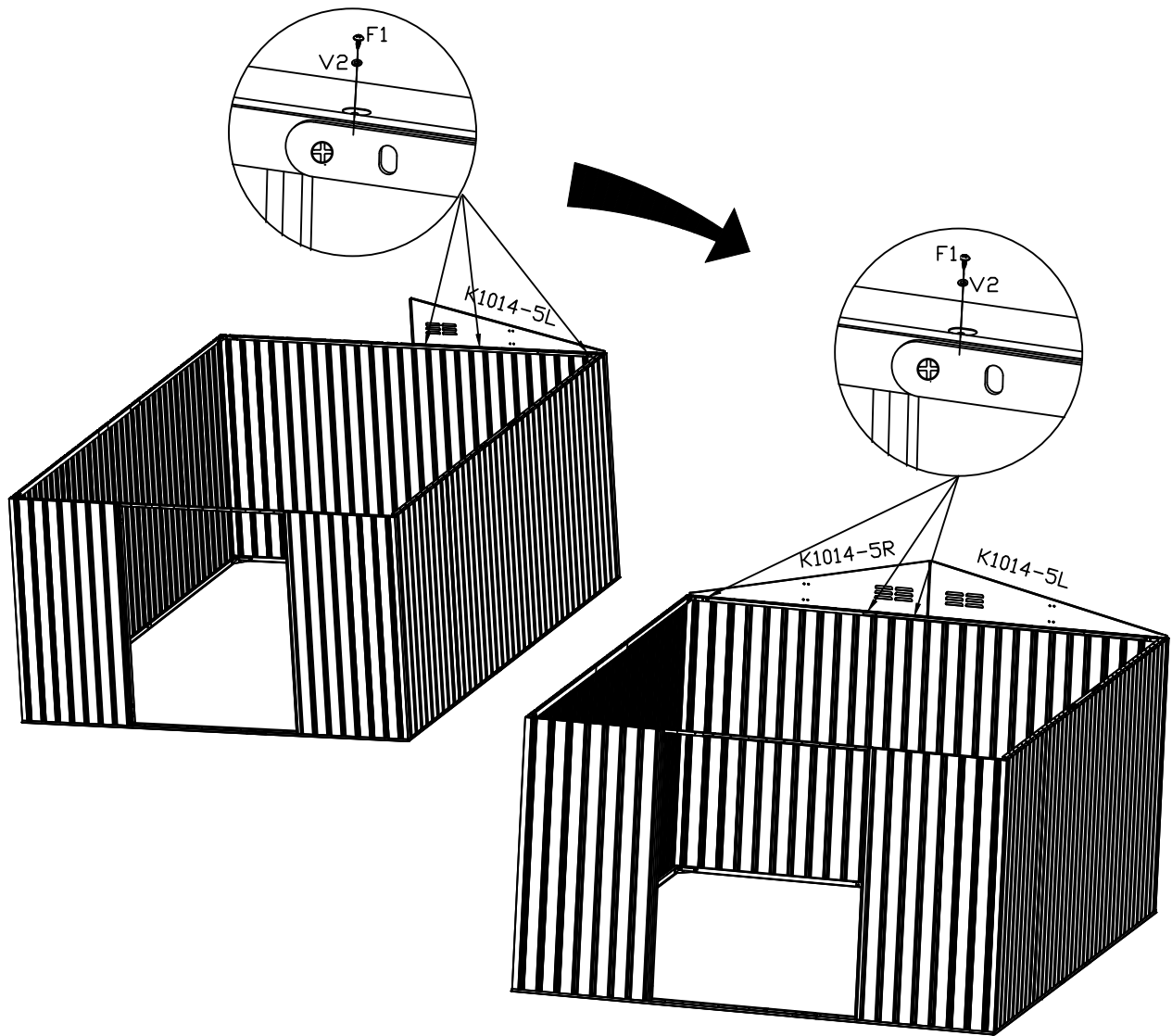

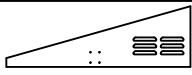
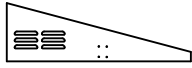

PART	NO.	QTY.
	K1014-5L	1
	K1014-5R	1
	F1	8
	V2	8

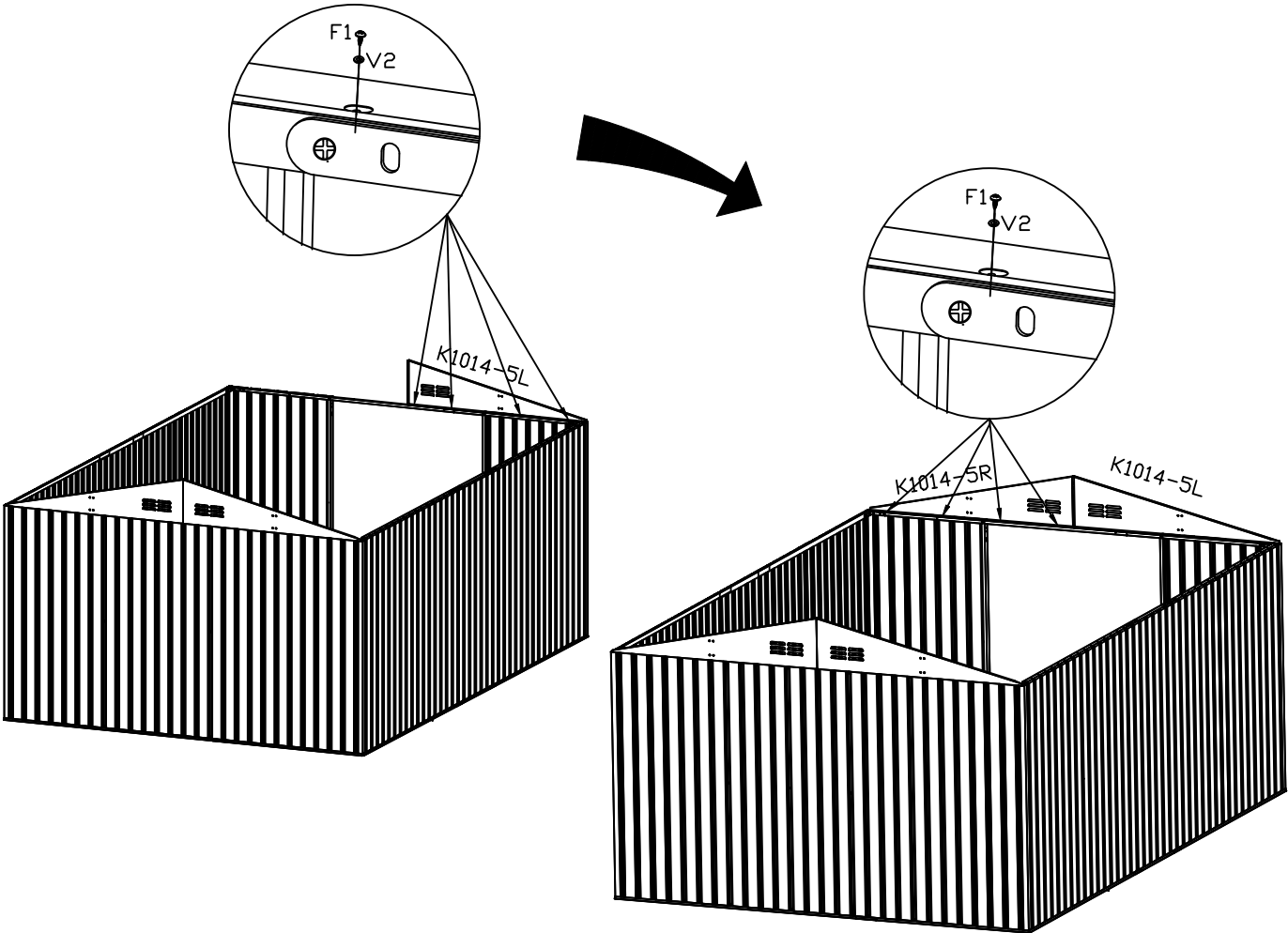

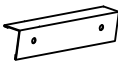



PART	NO.	QTY.
	K1014-5L	1
	K1014-5R	1
	F1	8
	V2	8

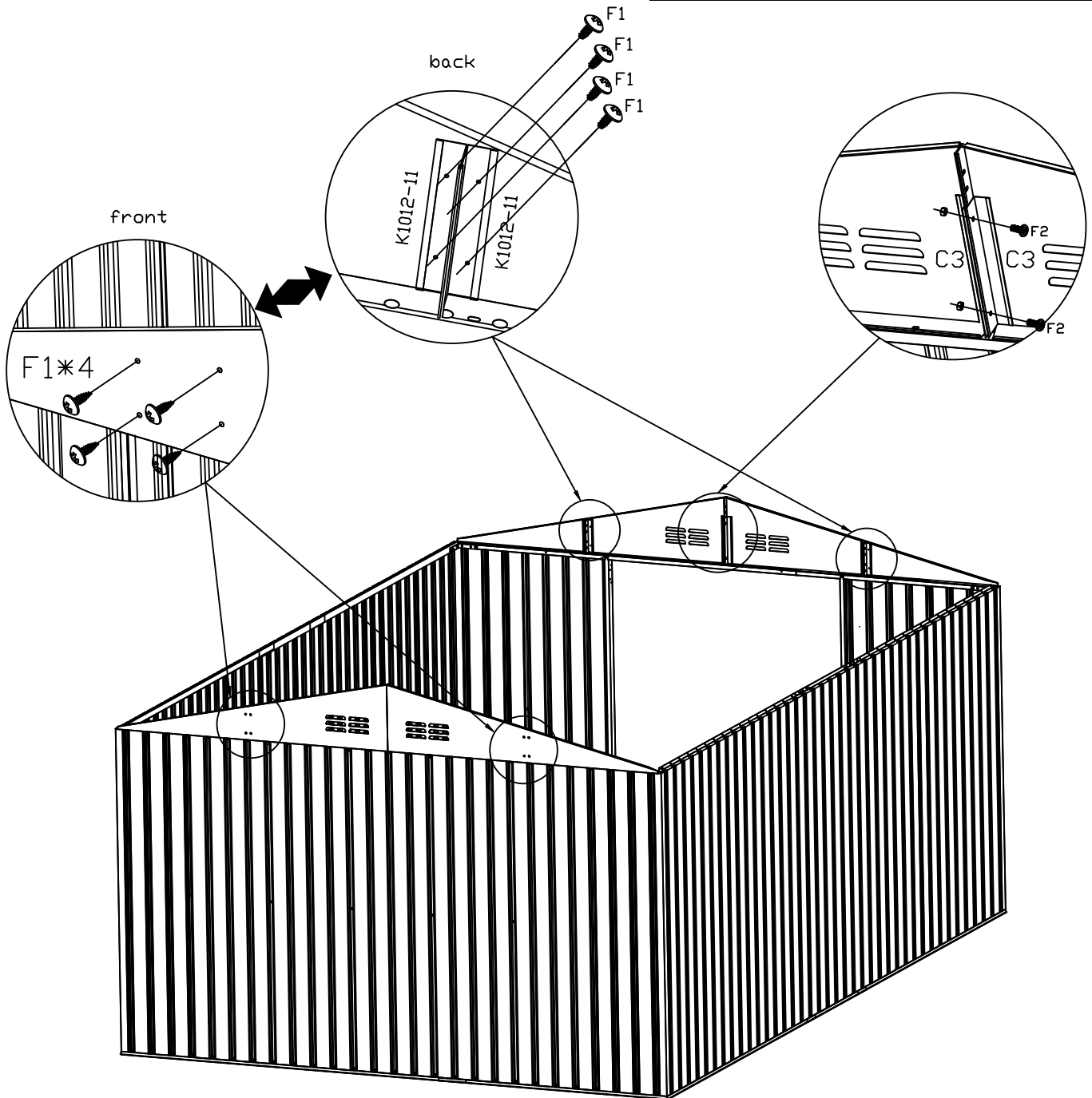
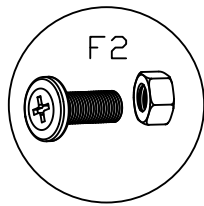



PART	NO.	QTY.
	C3	4
	K1012-11	8
	F2	4
	F1	16

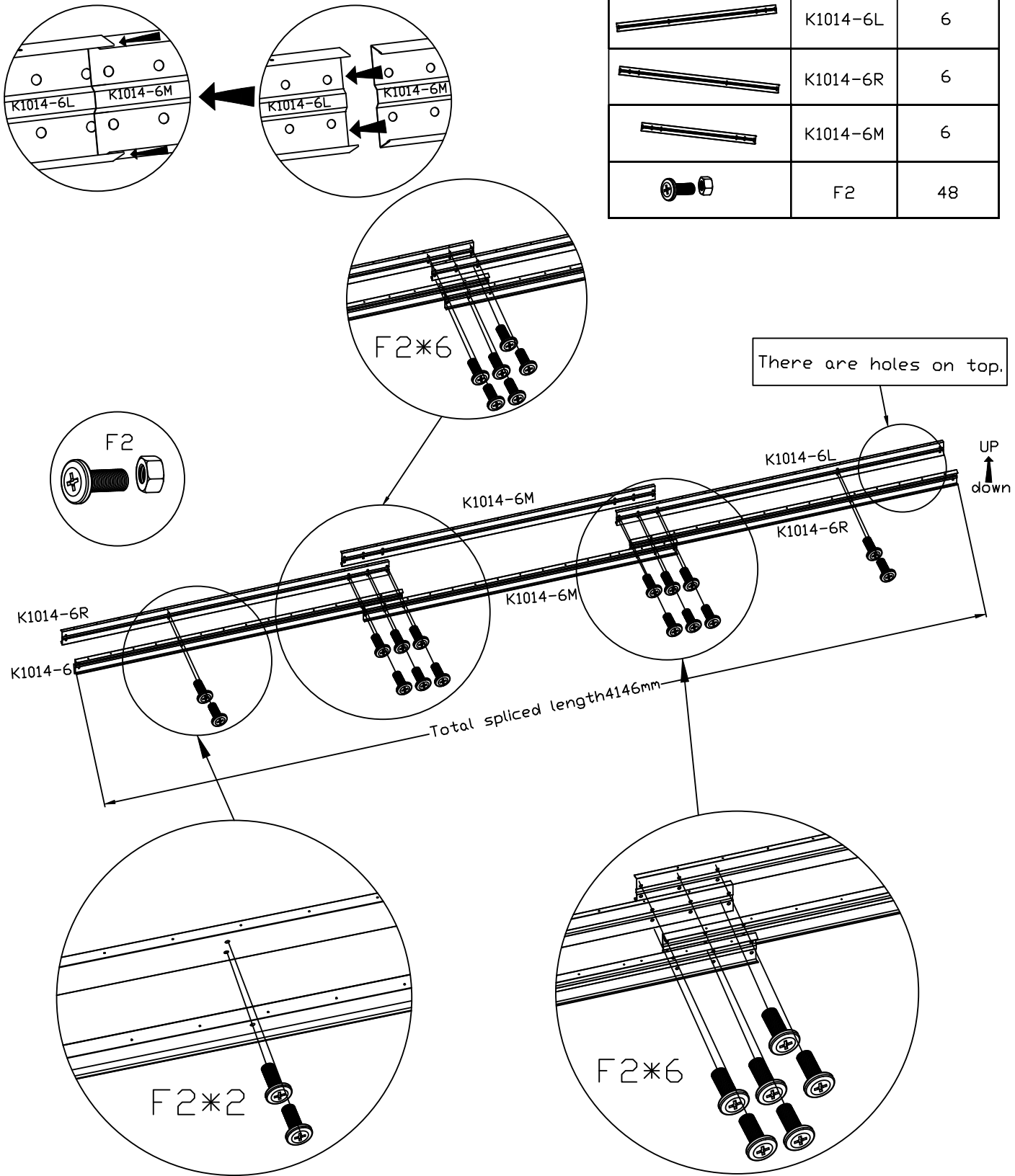

K1014-6M is narrower and should be inserted into K1014-6L and K1014-6R with the holes aligned.

PART	NO.	QTY.
	K1014-6L	6
	K1014-6R	6
	K1014-6M	6
	F2	48



PART	NO.	QTY.
	F2	12

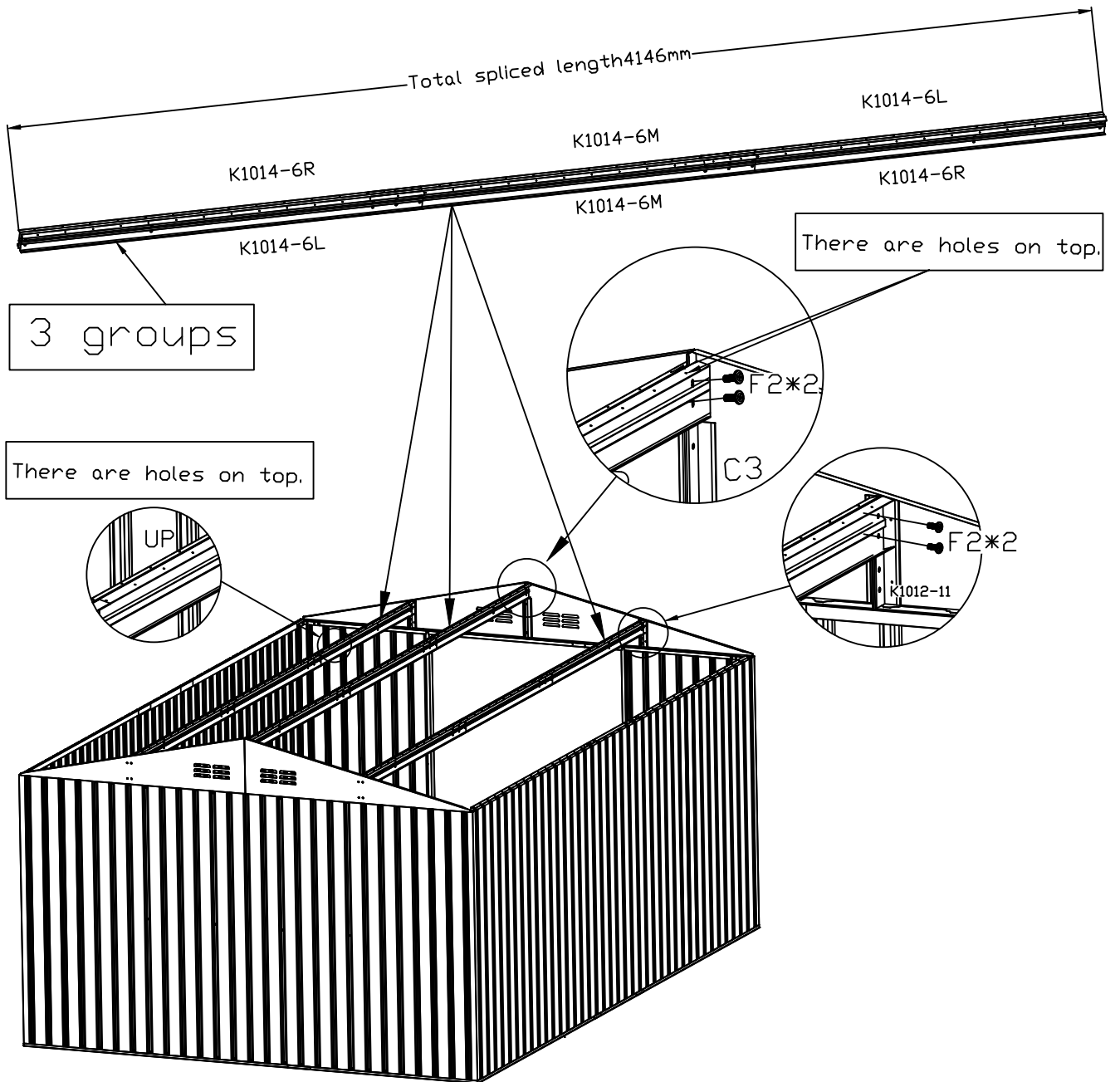

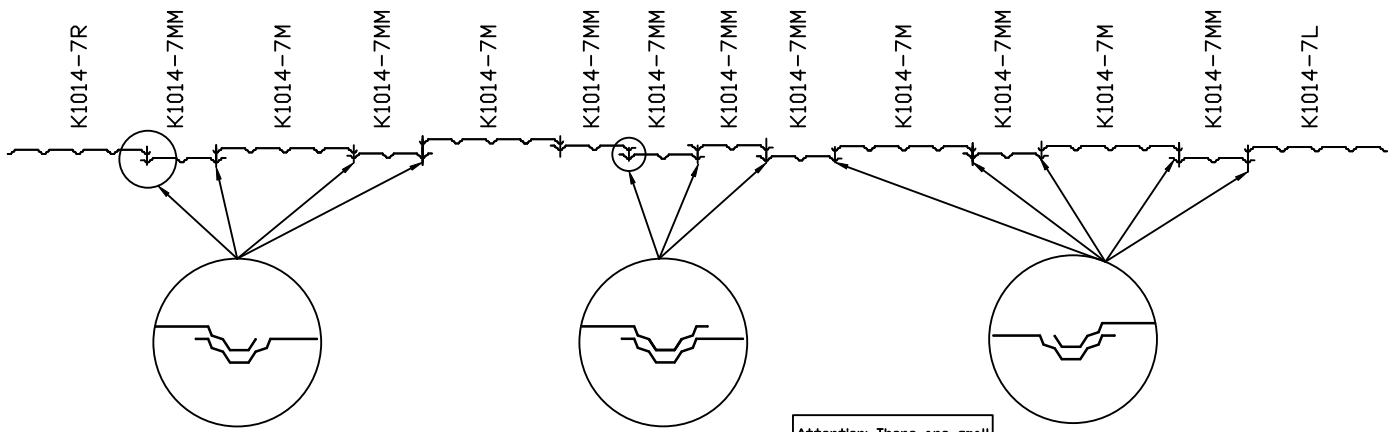

Attention! There are small holes on the outside for assembly with K810-8.

PART	NO.	QTY.
	K1014-7L	1
	K1014-7M	4
	K1014-7R	1
	K1014-7MM	8
	F1	91
	V2	91

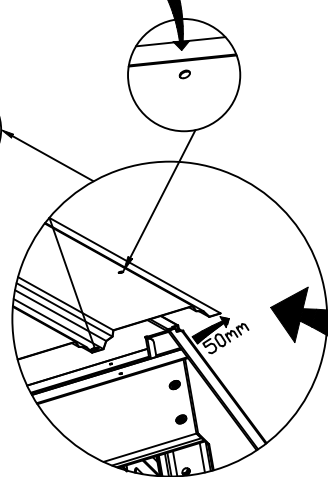
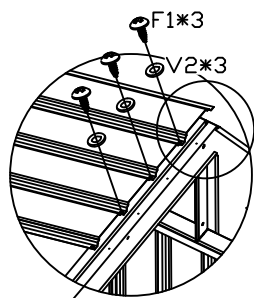
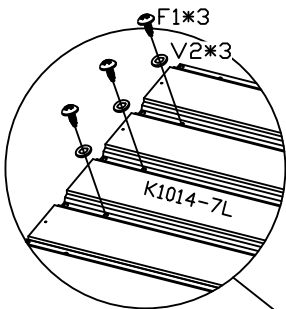

Installation according to the illustration! Extend the edge outward by approximately 50mm.

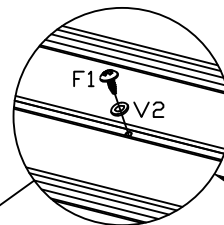
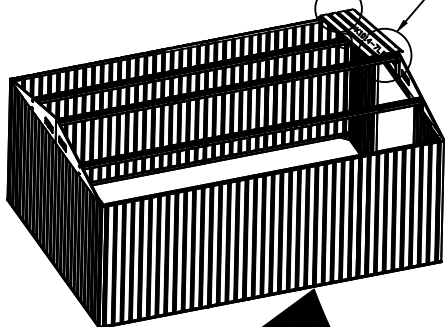

According to the installation diagram, the two plates at the center of the board are connected to the supporting beams K1014-6L, K1014-6M and K1014-6R using F1 screws.

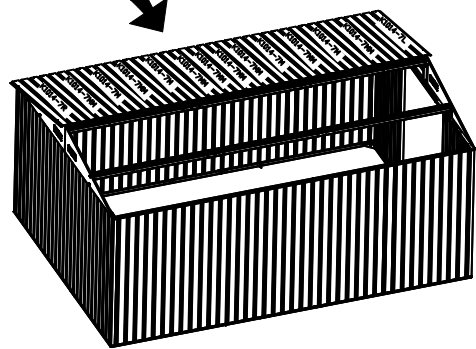
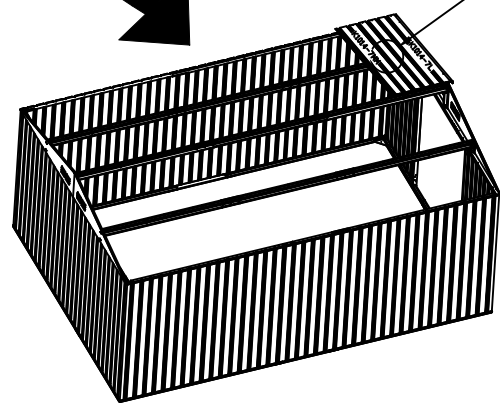

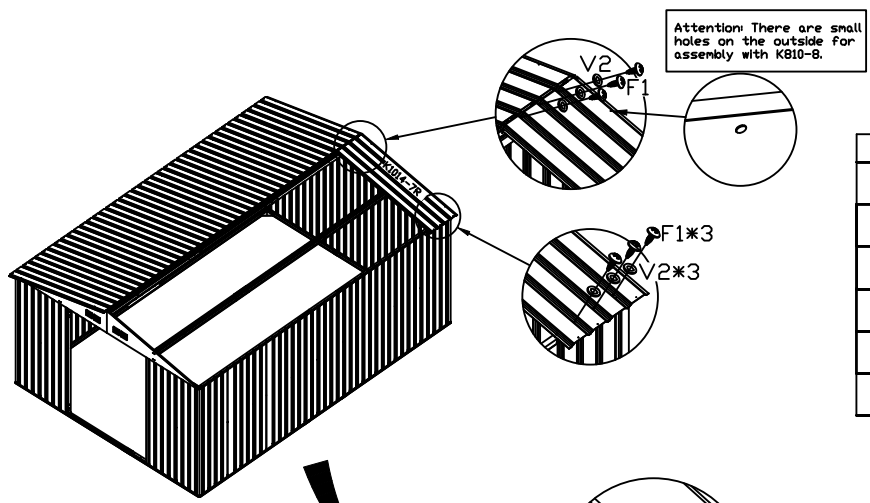
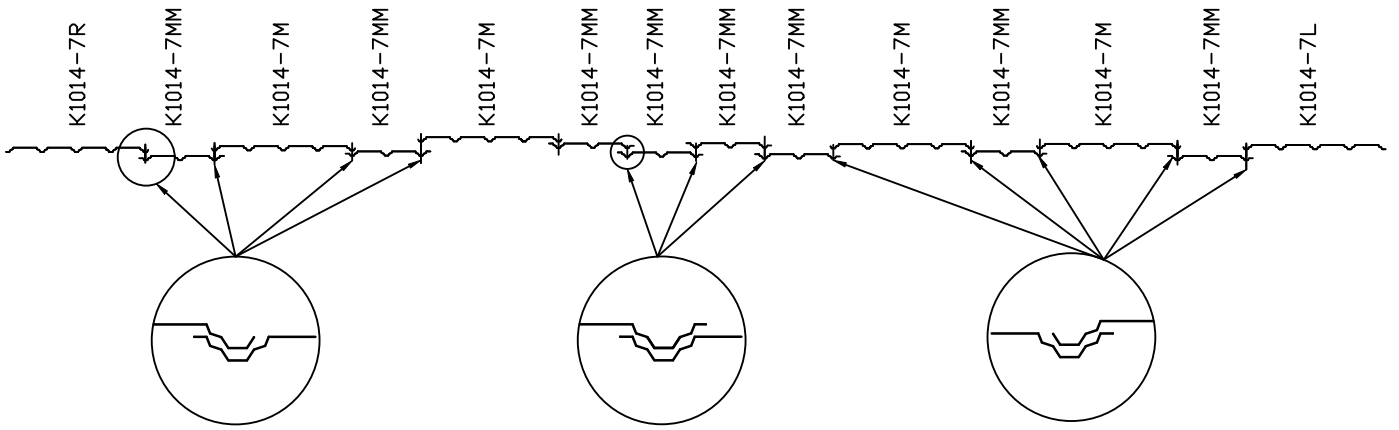

Attention: There are small holes on the outside for assembly with K810-8.



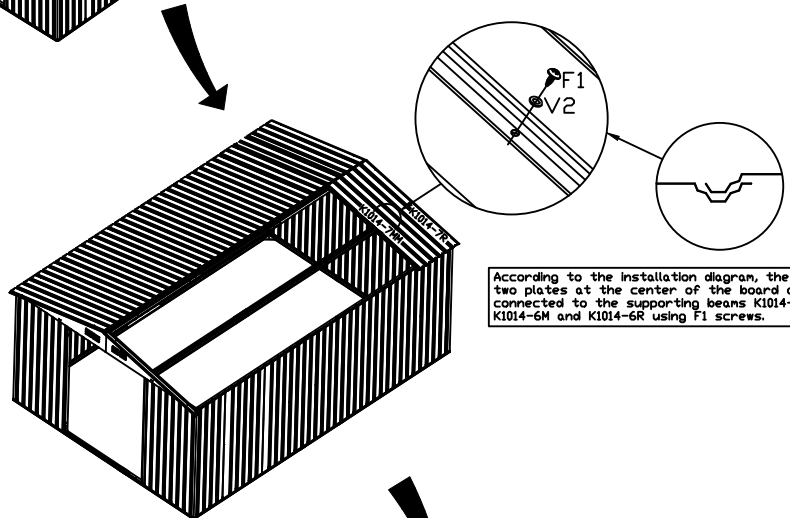

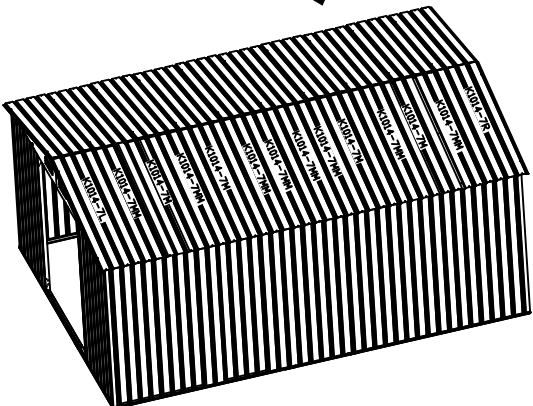

PART	NO.	QTY.
	K1014-7L	1
	K1014-7M	4
	K1014-7R	1
	K1014-7MM	8
	F1	91
	V2	91

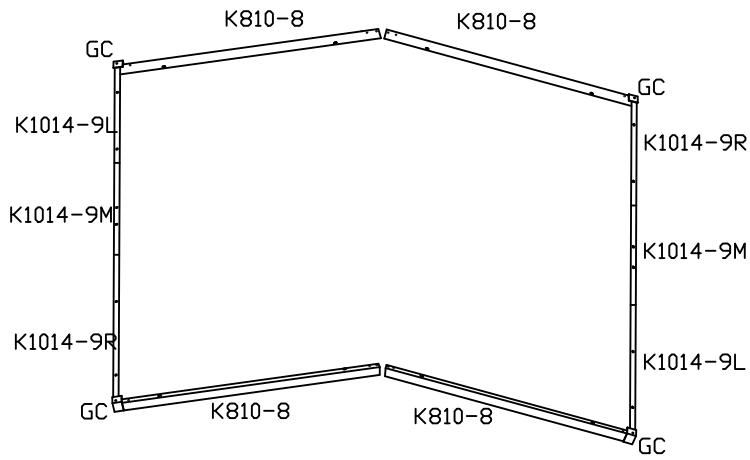





According to the installation diagram, the two plates at the center of the board are connected to the supporting beams K1014-6L, K1014-6M and K1014-6R using F1 screws.



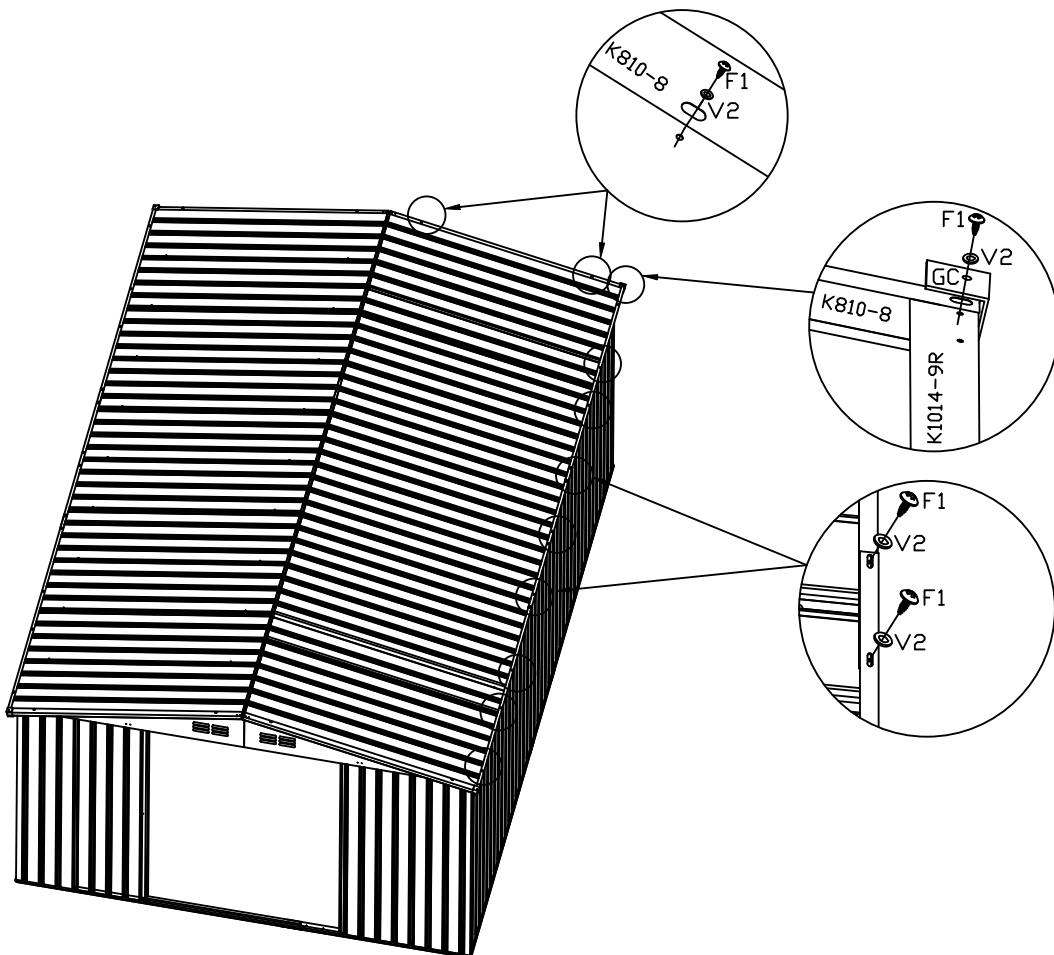





PART	NO.	QTY.
	K810-8	4
	K1014-9L	2
	K1014-9R	2
	K1014-9M	2
	GC	4
	F1	36
	V2	36

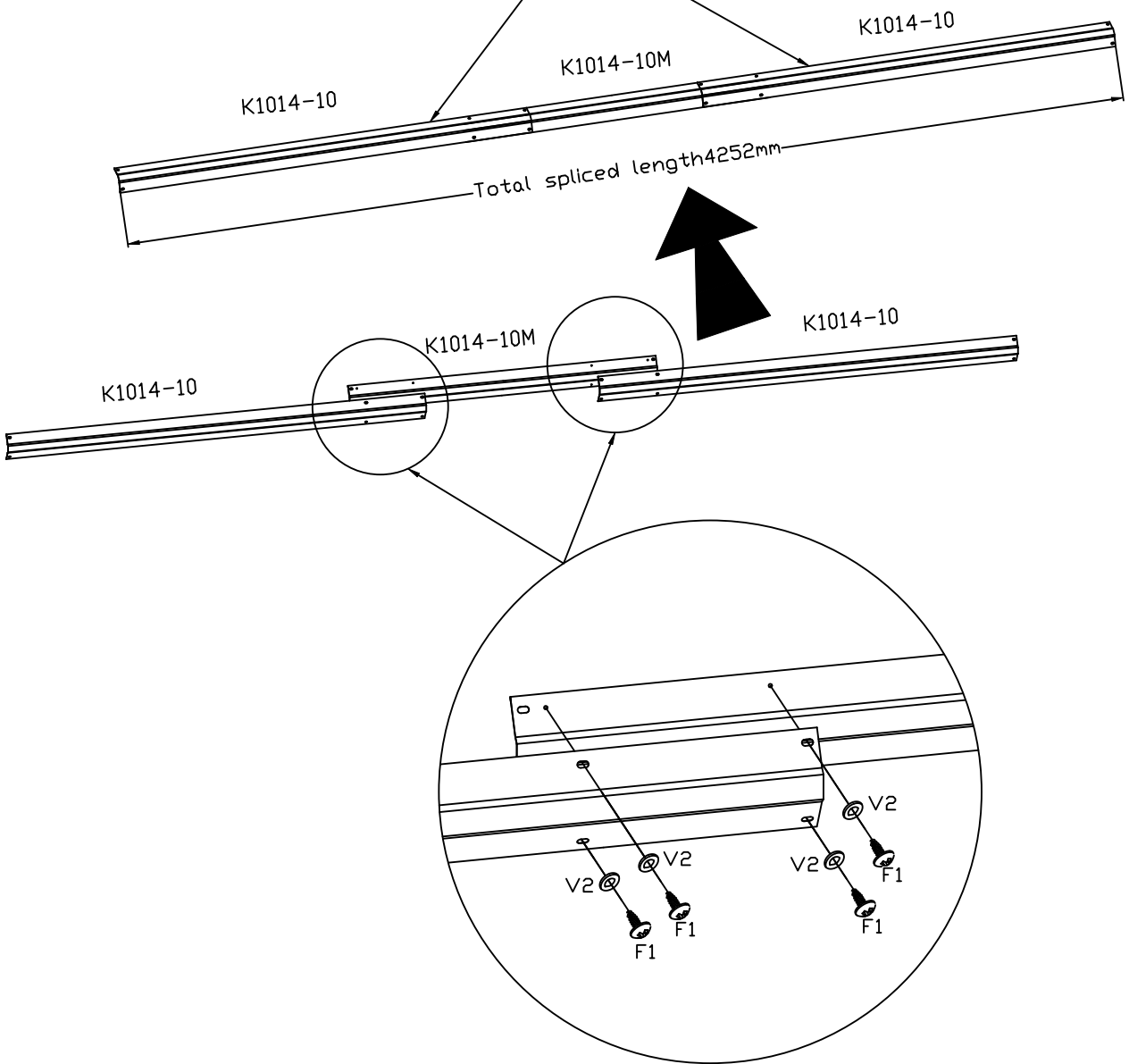

PART	NO.	QTY.
	K1014-10	2
	K1014-10M	1
	F1	8
	V2	8

According to the illustration: The three components of the roof rain shield must be connected using F1 self-tapping screws before proceeding with the subsequent installation.



PART	NO.	QTY.
	GE	2
	V2	4
	F4	4

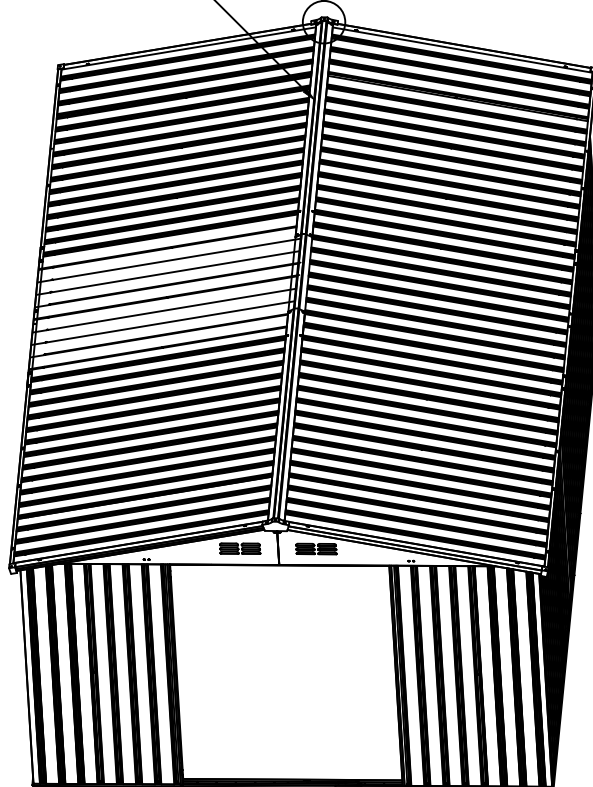
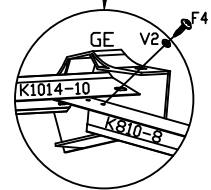
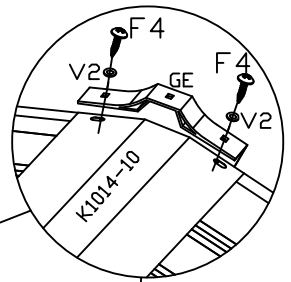
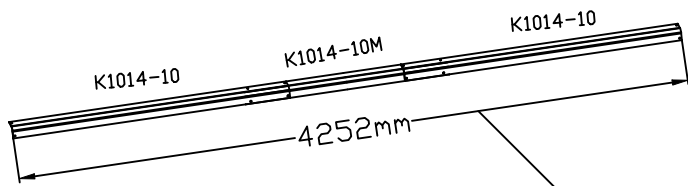
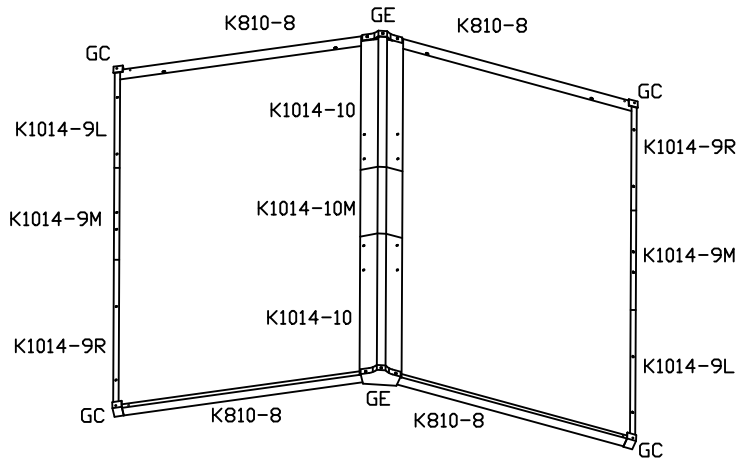

Left door panel splicing

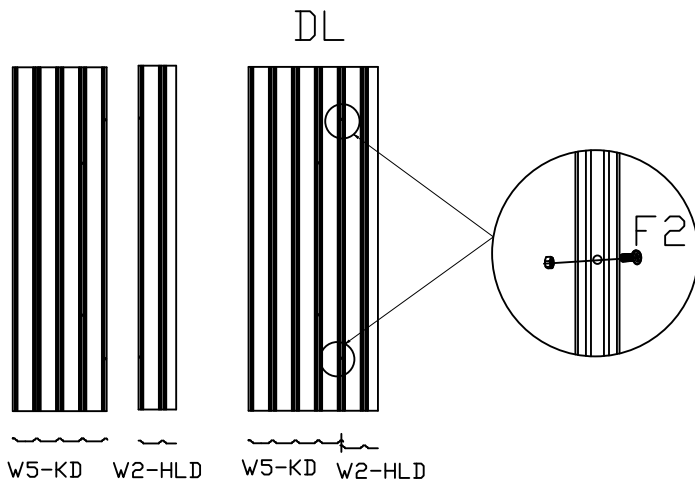

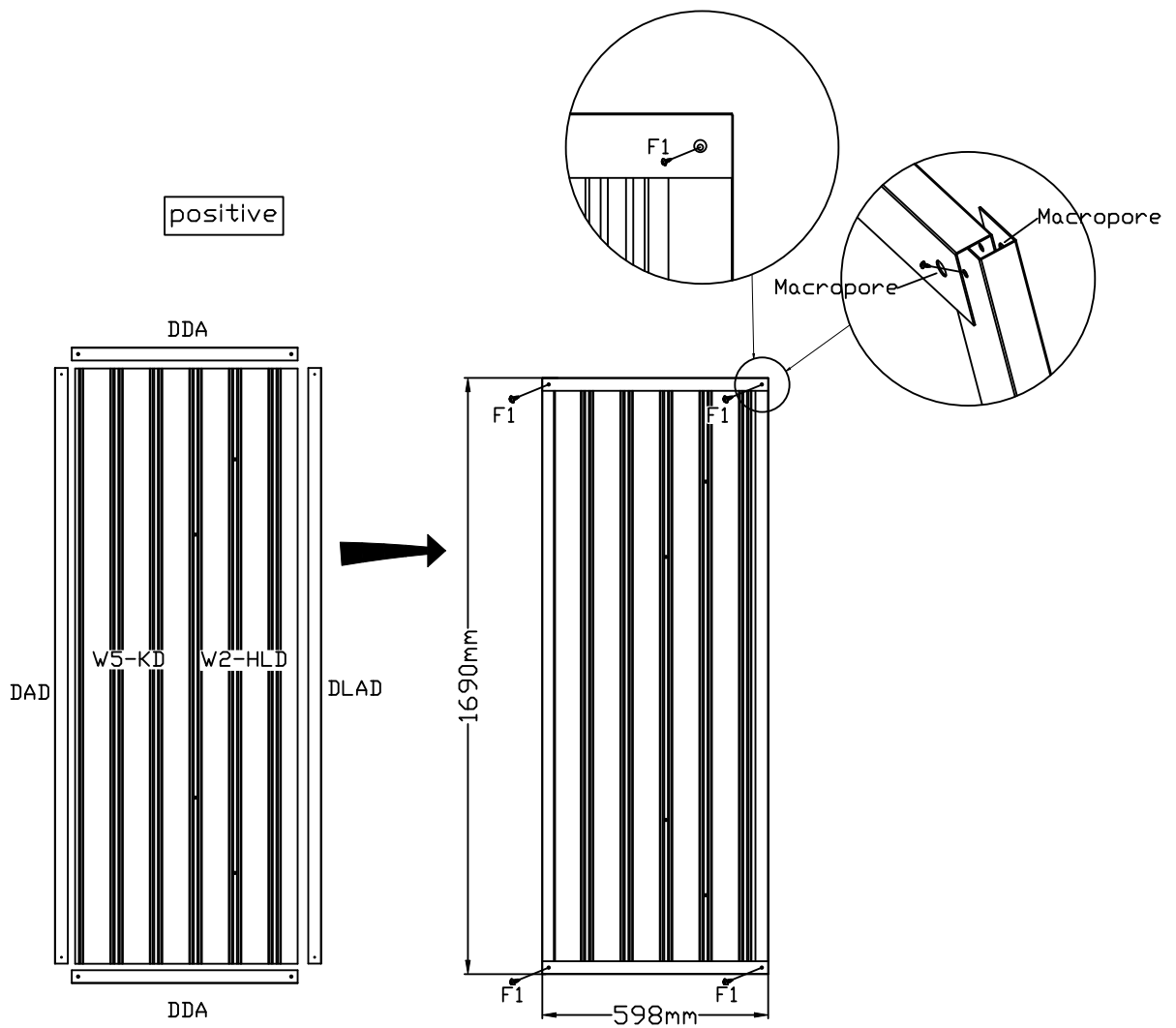

PART	NO.	QTY.
	W5-KD	1
	W2-HLD	1
	DAD	1
	DLAD	1
	DDA	2
	F1	4
	F2	2



Left door panel splicing

Attention: Installation sequence of screws ① → ② → ③ → ④ → ⑤ → ⑥ → ⑦

PART	NO.	QTY.
	DBD	2
	F1	5
	F2	2

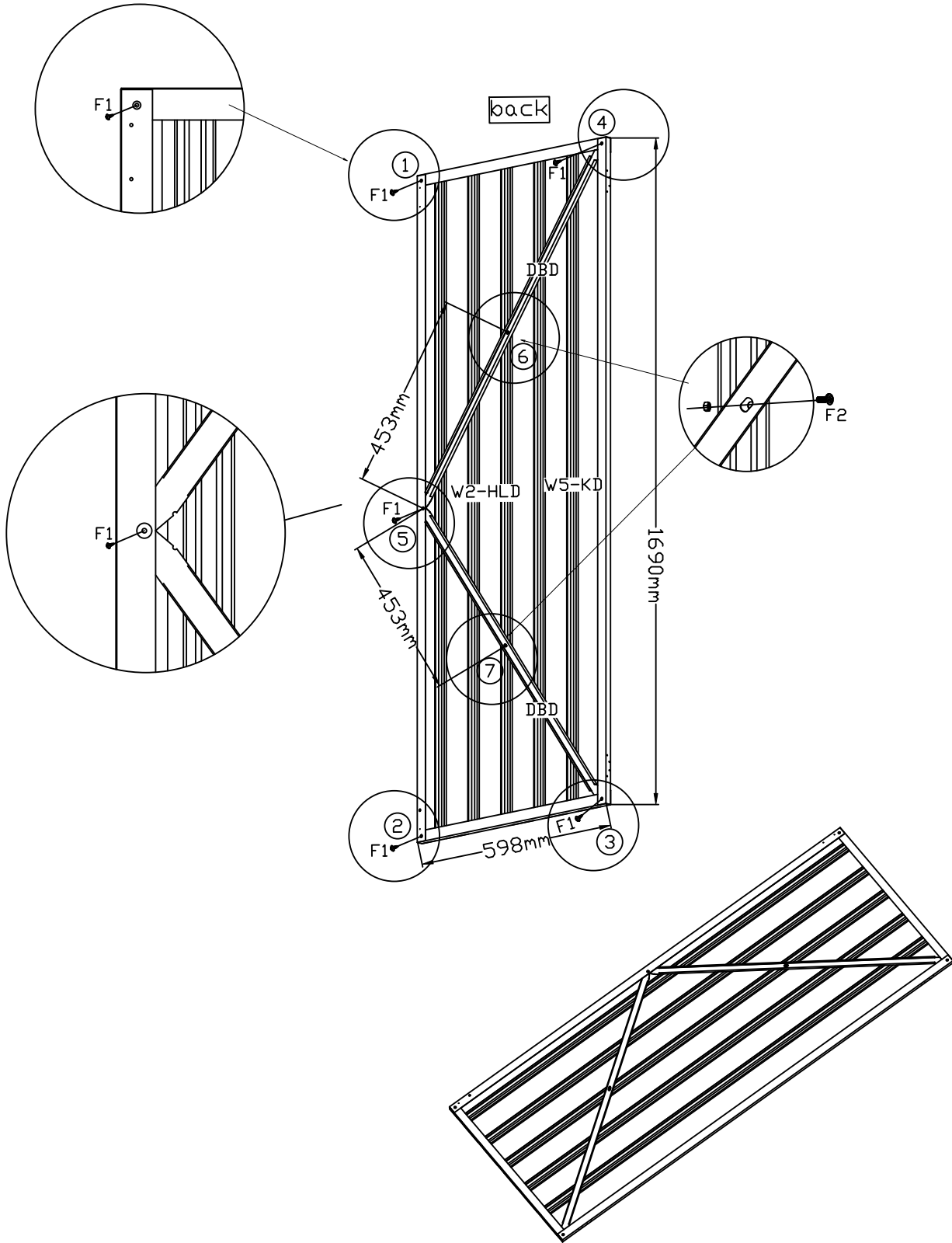

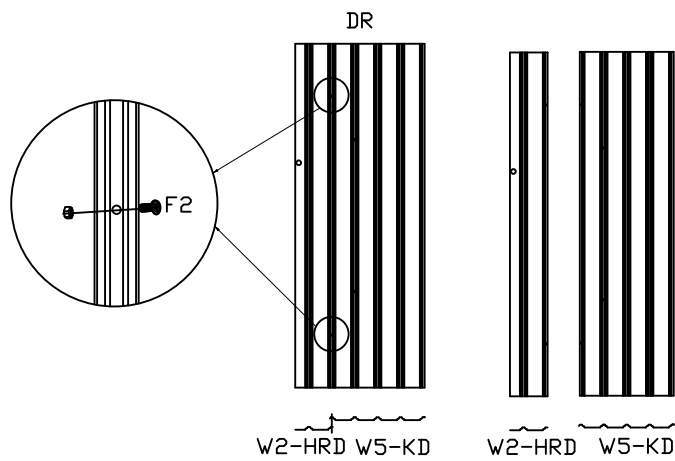

Right door panel splicing

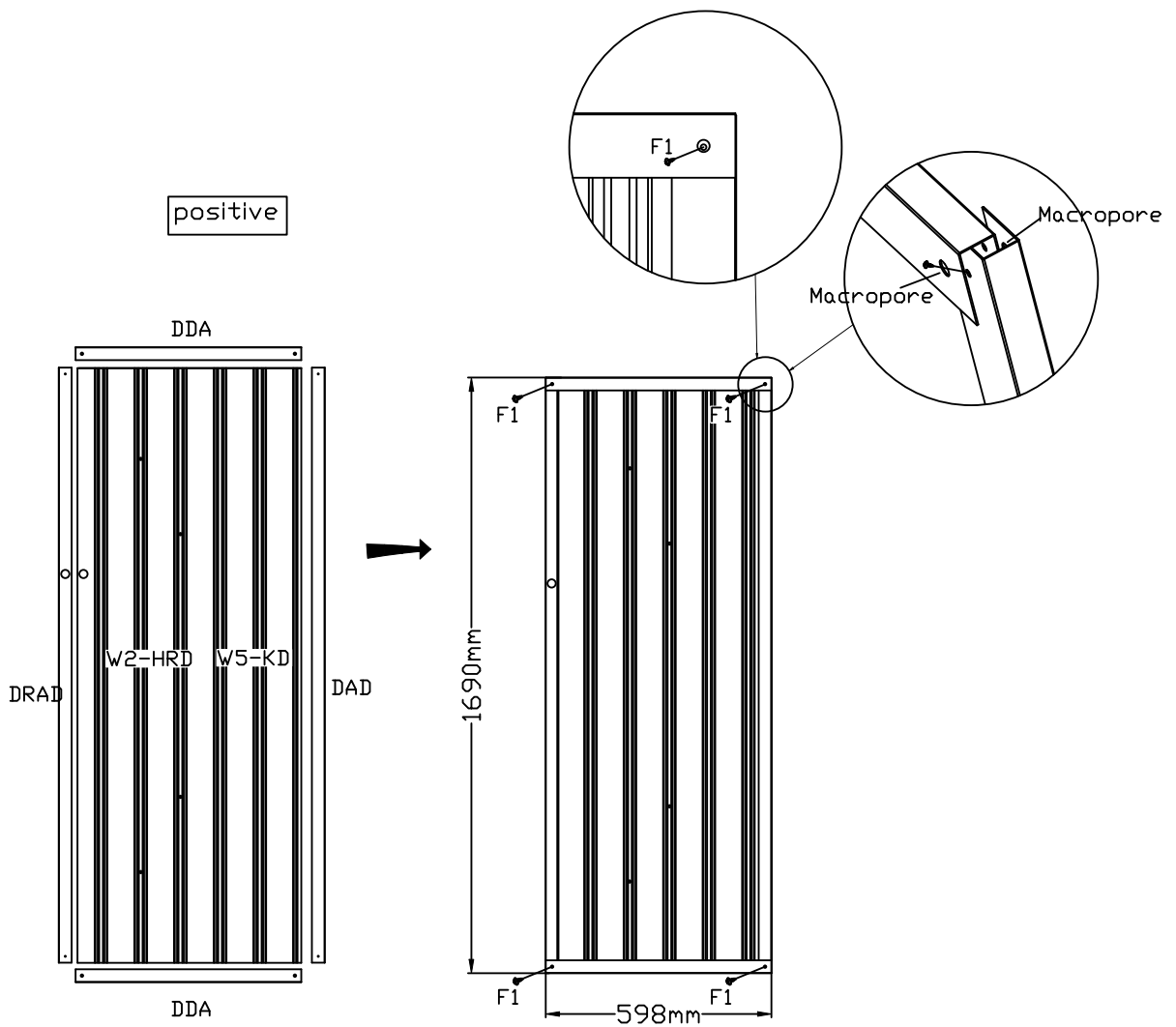

PART	NO.	QTY.
	W5-KD	1
	W2-HRD	1
	DAD	1
	DRAD	1
	DDA	2
	F1	4
	F2	2







Right door panel splicing

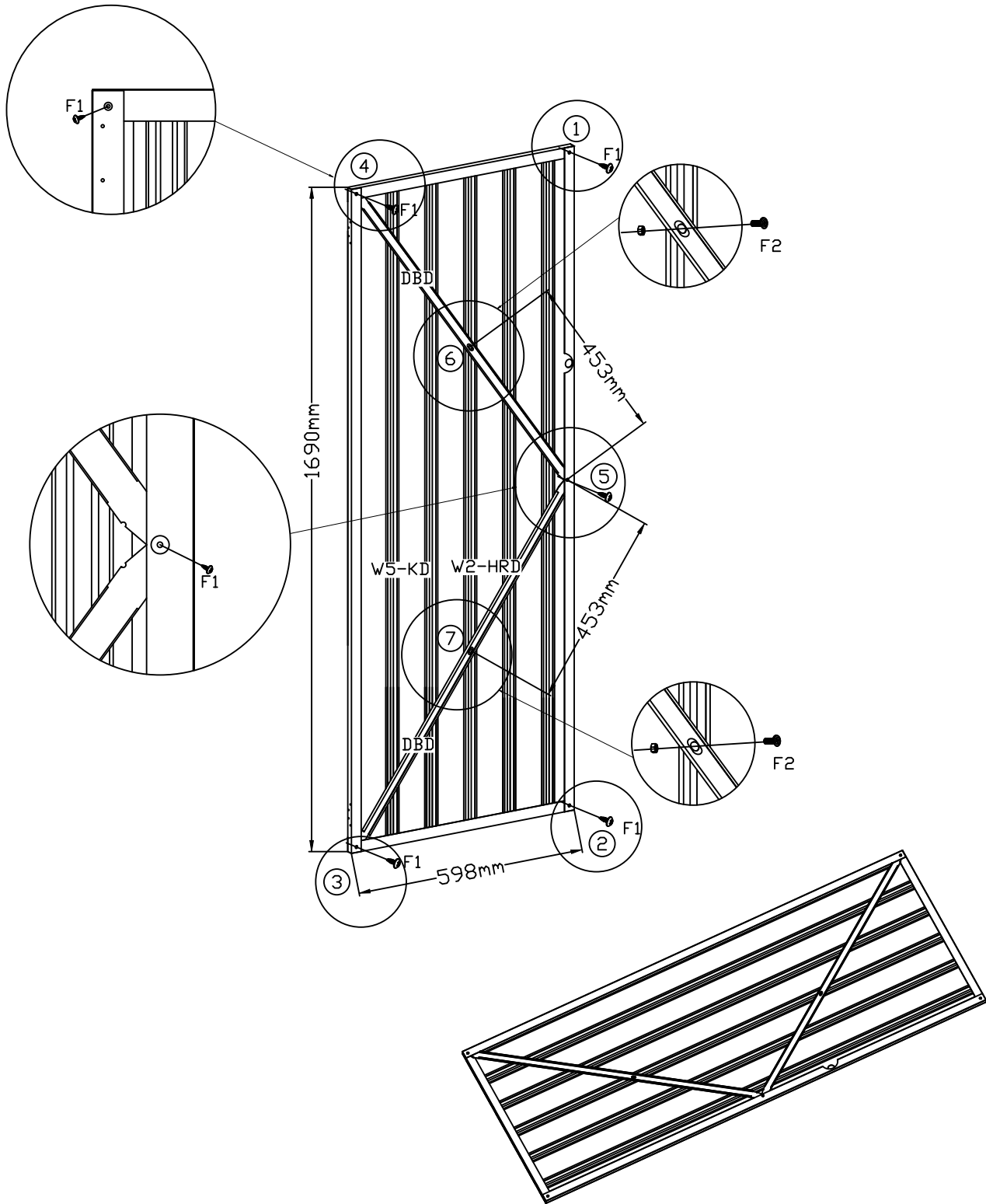

PART	NO.	QTY.
	DBD	2
	F1	5
	F2	2

Attention: Installation sequence of screws ① → ② → ③ → ④ → ⑤ → ⑥ → ⑦

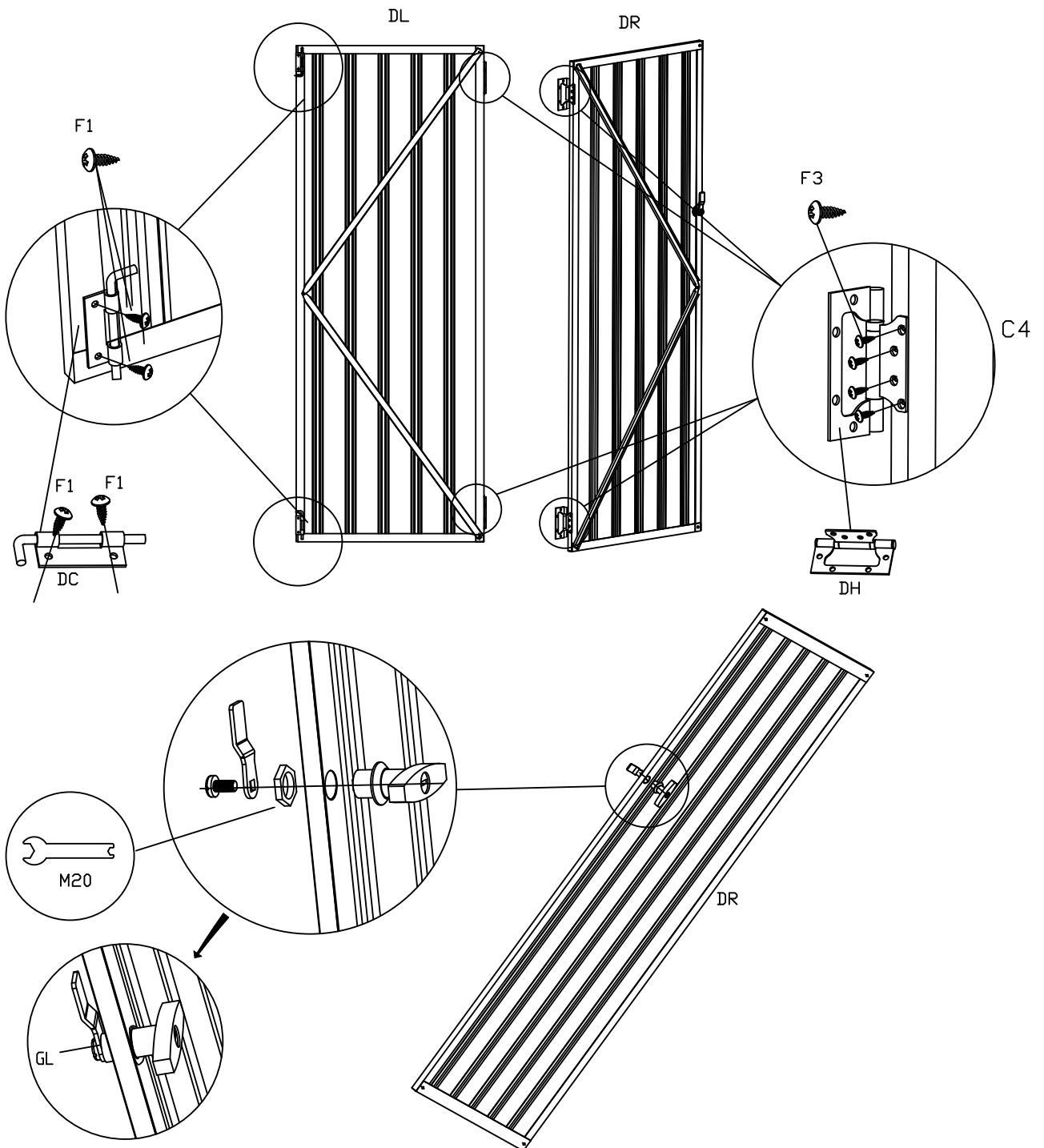

PART	NO.	QTY.
	DH	4
	DC	2
	F3	16
	GL	1
	F1	4



PART	NO.	QTY.
	DL	1
	DR	1
	F3	16

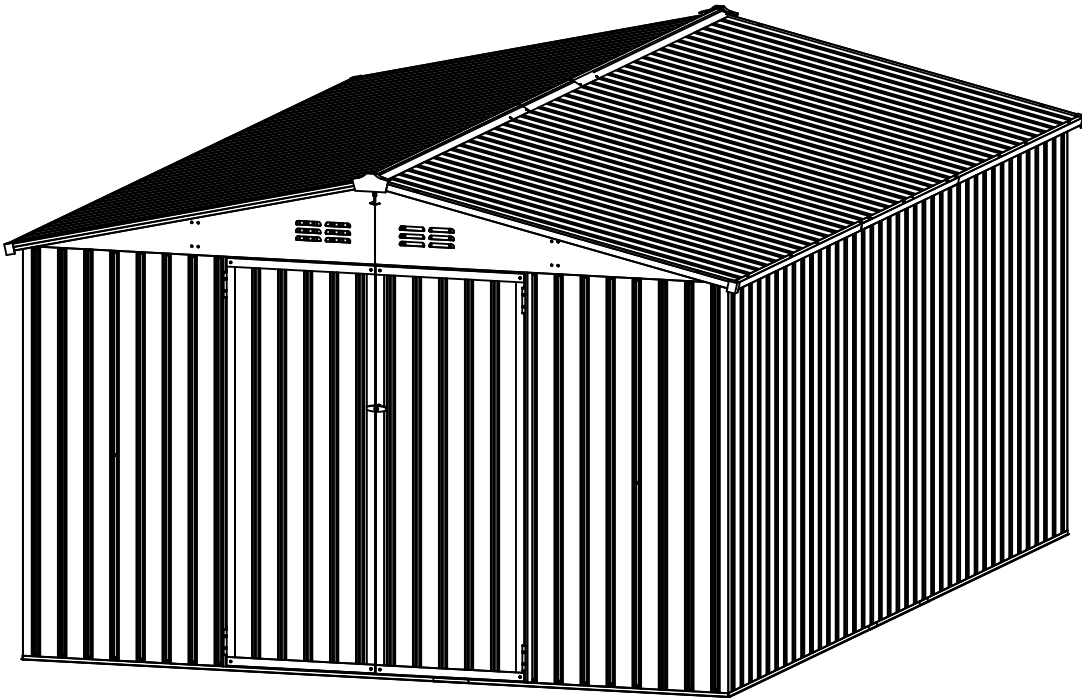
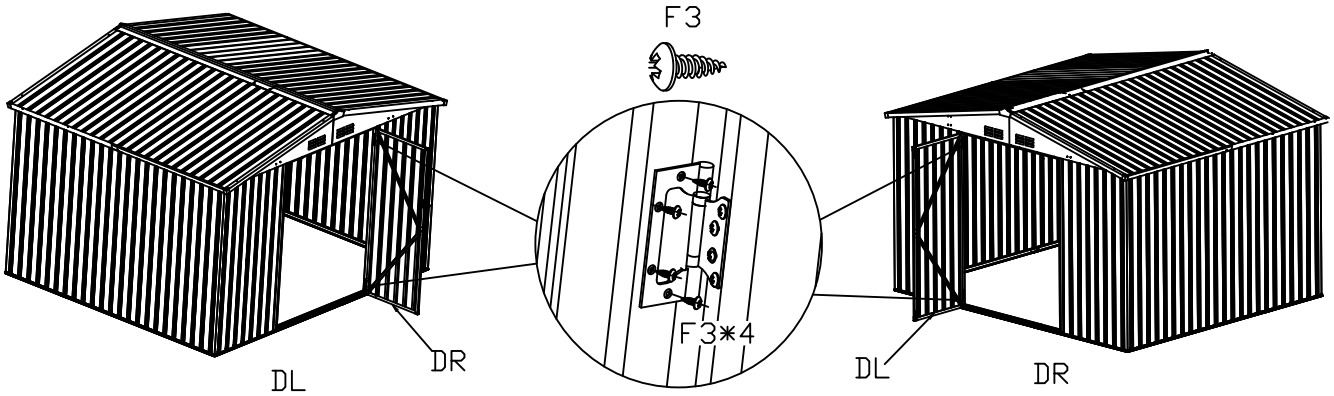

PART	NO.	QTY.
	SL	112

