

ASSEMBLY INSTRUCTIONS

ASSEMBLY TIPS:

1. Remove hardware from box and sort by size.
2. Please check to see that all hardware and parts are present prior to start of assembly.
3. Please follow attached instructions in the same sequence as numbered to assure fast & easy assembly.



Warning!

1. Don't attempt to repair or modify parts that are broken or defective. Please contact the store immediately.
2. This product is for home use only and not intended for commercial establishment.

PARTS IDENTIFICATION:

A CHAIR FRAME

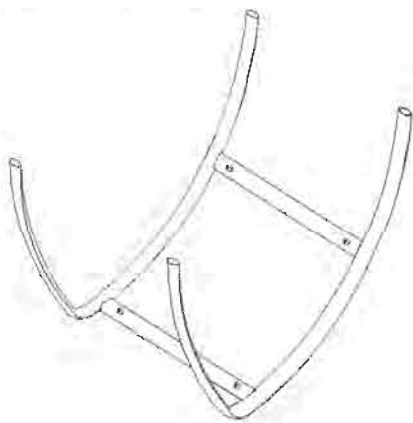

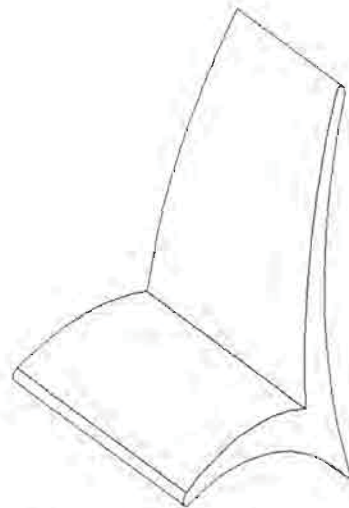

2PCS

B CHAIR SEAT AND BACKREST



2PCS

Z	HARDWARE IDENTIFICATION		
	DESCRIPTION		QTY
1	BOLT Φ8mmx30mm		8PCS
2	ALLEN WRENCH 5mm		2PCS
3	WASHER Φ18mm		8PCS

NOTE: QUANTITIES SHOWN ARE FOR TWO CHAIRS

ATTENTION:IT NEED ONE PERSON AND IT WILL TAKE ABOUT FIVE MINUTES TO ASSEMBLE THE ITEM.

STEP 1

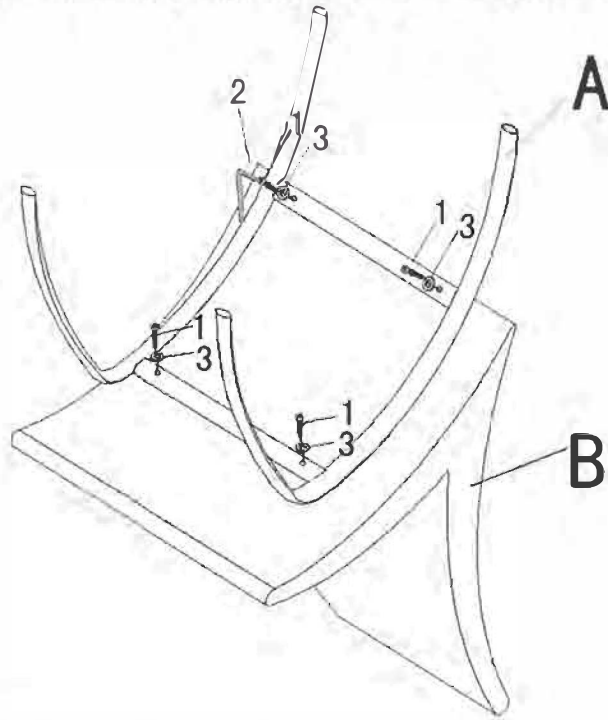

TAKE CHAIR FRAME (A) TO CHAIR BACKREST (B) LIKE THE FIGURE.
FASTEN BOLT (1) AND WASHER (3) BY ALLEN WRENCH (2).

STEP 2

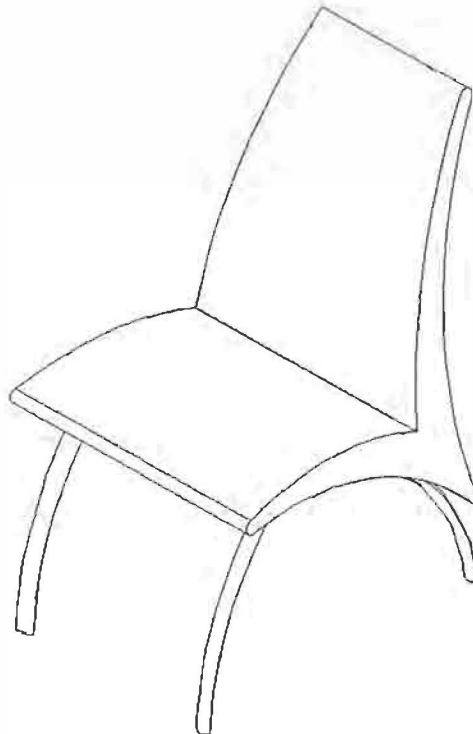

CHECK STABILITY OF THE CHAIR AND OVERTURN IT.