

TUMBLE DRYER

Execution standards

IEC60335-1:2010+A1:2013+A2:2016

IEC60335-2-11:2019



- Please read this manual carefully before use
- Our company reserves the final interpretation right of the instruction manual
- Please refer to the actual product for its appearance

USER MANUAL

Catalogue

Product features	3
Part name	3
Pre-Use Precautions(Very Important)	4
Electrical Safety(Electrical Safety Tips)	4
Usage requirement	5
Installation	6
1.Vent Pipe Connector Installation	6
2. Install the clothes dryer horizontally	6
3.Optionalinstallation Methods	7
Daily Maintenance	8
1.Cleaning the Exhaust Air Filter	8
2.Intake Air Filter(Clean every ten uses)	8
3.Machine Cleaning	9
Common Troubleshooting	10
Fault Alarm Handling	11
Product Specifications	12
Packaging List	12
Specification	Back cover

Product features

This series of drum dryers features a temperature auto-control function, which significantly improves drying efficiency while also enhancing the fluffiness and softness of the clothes, maintaining afresh, shiny appearance and a gentle care for the garments.

1. Easy to operate, one click access, convenience-providing
2. Easy to use, automatic sensing, time-saving.
3. Easy to install with various options, satisfying.
4. Multiple program selections, easily comprehensible, fulfilling

Part name

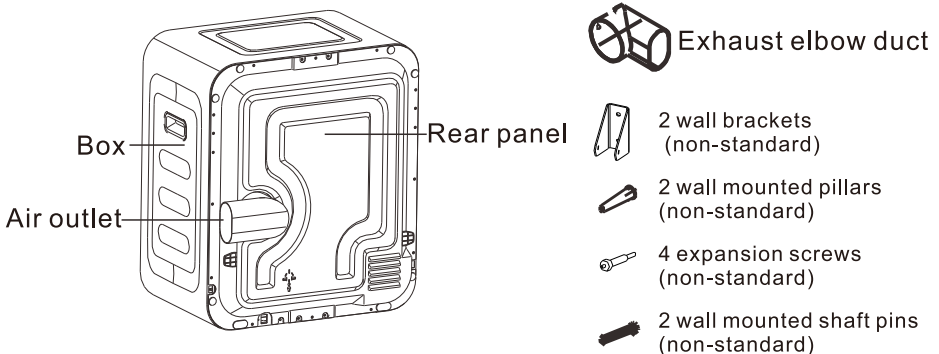
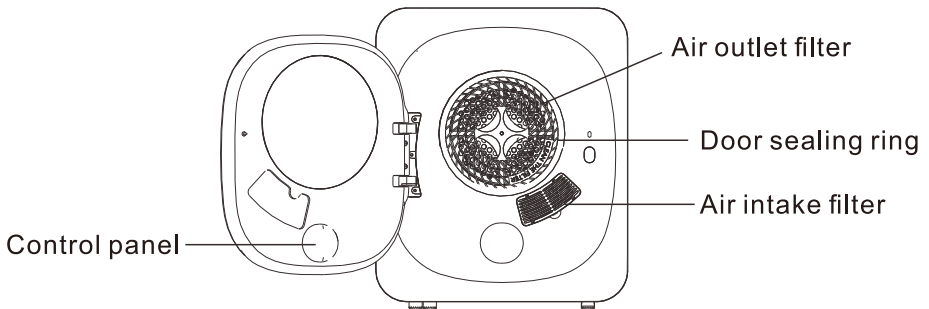

Pre-Use Precautions(Very Important)

I. Electrical Safety(Electrical Safety Tips)



- Read the instructions.
- Please insert the power cord plug into a dedicated socket with a single-phase three-wire 220V AC power supply and a current of 10A or above. The grounding terminal of the socket must be reliably grounded. It is recommended to use a residual current device(RCD)for added safety.
- During the operation of the dryer, do not place flammable or volatile substances(such as gasoline, alcohol)near the dryer to prevent fire.
- Never install the dryer in damp or potentially wet areas such as bathrooms to avoid electrical shocks or leakage accidents.
- When the dryer is in normal use, the power cord plug should be easily accessible for insertion and removal. In case of a power outage, movement, non-use, or cleaning, always unplug the power cord. Do not use wet hands to insert or remove the plug.
- It is strictly forbidden to operate the dryer on top of packaging foam. This can lead to fire due to poor heat dissipation or other external factors.
- When the drum interior or the exterior of the dryer is dirty, clean it with a soft, damp cloth. Do not rinse with water directly and do not use volatile oils (such as alcohol, gasoline)for cleaning.
- This appliance can be used by children aged from 8 years and above and persons with reduced physical, sensory or mental capabilities or lack of experience and knowledge if they have been given supervision or instruction concerning use of the appliance in a safe way and understand the hazards involved. Children shall not play with the appliance. Cleaning and user maintenance shall not be made by children without supervision.
- Children of less than 3 years should be kept away unless continuously supervised.
- If the supply cord is damaged, it must be replaced by the manufacturer, its service agent or similarly qualified persons in order to avoid a hazard.
- The tumble dryer is not to be used if industrial chemicals have been used for cleaning.
- The lint trap has to be cleaned frequently.
- Lint must not to be allowed to accumulate around the tumble dryer.
- Adequate ventilation has to be provided to avoid the back flow of gases into the room from appliances burning other fuels, including open fires.
- Fill steam generators only with liquids specified by the manufacturer.
- **WARNING:** Never stop a tumble dryer before the end of the drying cycle unless all items are quickly removed and spread out so that the heat is dissipated.
- **WARNING:** The appliance must not be supplied through an external switching device, such as a timer, or connected to a circuit that is regularly switched on and off by a utility.

- A carpet must not obstruct the openings.
- Exhaust air must not be discharged into a flue that is used for exhausting fumes from appliances burning gas or other fuels.
- The appliance must not be installed behind a lockable door, a sliding door or a door with a hinge on the opposite side to that of the tumble dryer, in such a way that a full opening of the tumble dryer door is restricted.

II. Usage Requirements

- Garments should be thoroughly dehydrated before being placed in the dryer for drying. (Clothes that are wrung by hand may contain a amount of moisture, which can lead to leaking and increased drying time. This should be avoided.)
- Remove all objects from pockets such as lighters and matches.
- Fasten zippers, buttons, etc., and turn the clothes inside out before drying. (This can reduce noise from collision with the drum.)
- Garments labeled "Do not wash with water" or "Dry clean only" should not be dried in the dryer.
- Do not dry knitted fabrics, woolen clothes, or leather materials in the dryer, as plush and leather can be damaged, and woolen fabrics may shrink or deform.
- It is best to dry clothes of the same or similar texture in one session.
- Do not dry clothes that have the following care instructions: not suitable for tumble drying, hang drying, drip drying, flat drying, or air drying.
- During normal operation, do not cover the surface of the machine with any textiles. The surface temperature of the machine may be slightly higher than body temperature during operation, which is a normal phenomenon.
- Do not dry unwashed items in the tumble dryer.
- Items that have been soiled with substances such as cooking oil, acetone, alcohol, petrol, kerosene, spot removers, turpentine, waxes and wax removers should be washed in hot water with an extra amount of detergent before being dried in the tumble dryer.
- Items such as foam rubber (latex foam), shower caps, waterproof textiles, rubber backed articles and clothes or pillows fitted with foam rubber pads should not be dried in the tumble dryer.
- Fabric softeners, or similar products, should be used as specified by the fabric softener instructions.
- Remove all objects from pockets such as lighters and matches.

Installation

The dryer should be placed on a level and sturdy floor, table, or dedicated stand. When installing the dryer, it should be kept 10-15 cm away from the rear wall. If used in a confined space, a ventilation fan can be installed or a vent pipe can be attached to the exhaust outlet to expel the moist hot air to the outdoors.

1. Vent Pipe Connector Installation

Adjust the direction of the exhaust outlet connector as needed and secure it with a screw.

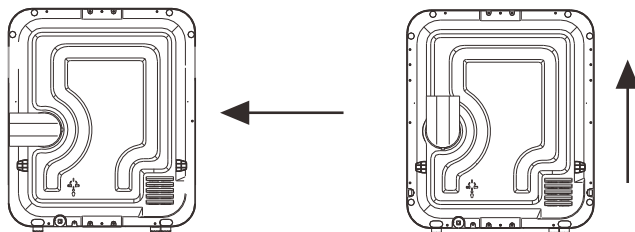

2. Install the clothes dryer horizontally

This dryer must not be placed upside down. When the dryer is installed on a level floor or table, make sure the surface is sturdy, secure, and not tilted to keep the dryer level.

3. Optional installation Methods

3.1 Dryer Bracket Installation

When using the dryer with a stand, it must be ensured that the stand is sturdy and reliable. When the stand is installed on the ground, it must be stable and secure, with a strong connection between the stand and the wall to ensure the stability of the stand. There should be at least 13 cm of distance between the stand and the wall (the stand is an optional accessory).

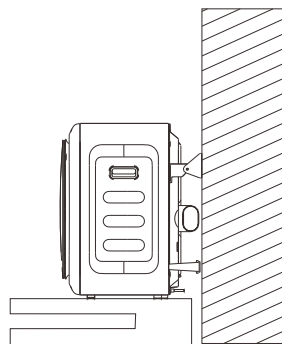

3.2 Wall-Mounted Dryer Installation

Determine the wall mounting position for the dryer, taking care to ensure that the space between the top of the dryer and the ceiling is recommended to be greater than 100mm. If the installation location is above a washing machine, leave enough space to open the washing machine's lid.

- Secure the hooks to the wall using expansion bolts (M6).
- Use 4 cross-head flat countersunk self-tapping screws (4x10, provided) to fix the cabinet hooks to the cabinet.
- Hang the dryer safely on the hooks.

Distance between
hook screw holes

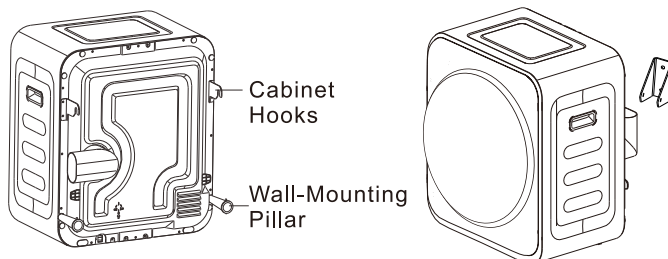
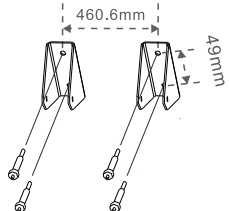

Note: Before wall-mounted installation, please measure the distance between the hook screw holes and then proceed with the installation.

Daily Maintenance

To ensure the normal operation of the dryer, it is necessary to clean the exhaust and intake air filters in a timely manner and also to clean the body of the dryer regularly. Before cleaning, please unplug the power plug from the socket!

1. Cleaning the Exhaust Air Filter (Clean after each use)

A. Removing the Filter: insert your hand into the drum and reach for the four holes next to the centre of the exhaust air mask, then pull the filter outwards to remove it.

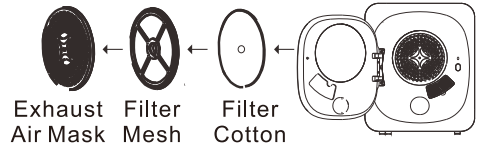

B. Cleaning Lint: Dismantle the exhaust air mask, filter cotton, and filter mesh separately. Use a soft-bristle brush or a vacuum cleaner to remove lint from the filter mesh and filter cotton, taking care not to damage the filter mesh



C. Installing the Filter: After cleaning assemble the filter in the order of the exhaust air mask, filter mesh, and filter cotton. Place the filter inside the drum, align the central concave part of the exhaust air mask with the central convex part of the drum to ensure it is properly installed

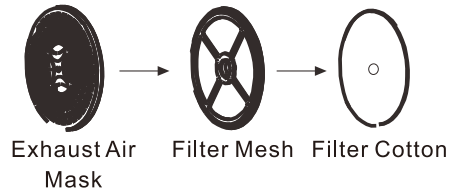

2. Intake Air Filter (Clean every ten uses)

1) Gently push the outer side of the middle part of the intake air filter cover upwards and pull it outward to remove it.

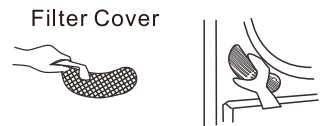

2) Use a soft-bristle brush or a vacuum cleaner to clean any dust or debris adhered to it.

3) After cleaning, replace the filter cover back on the machine

3. Machine Cleaning



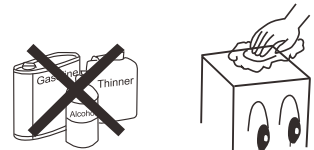



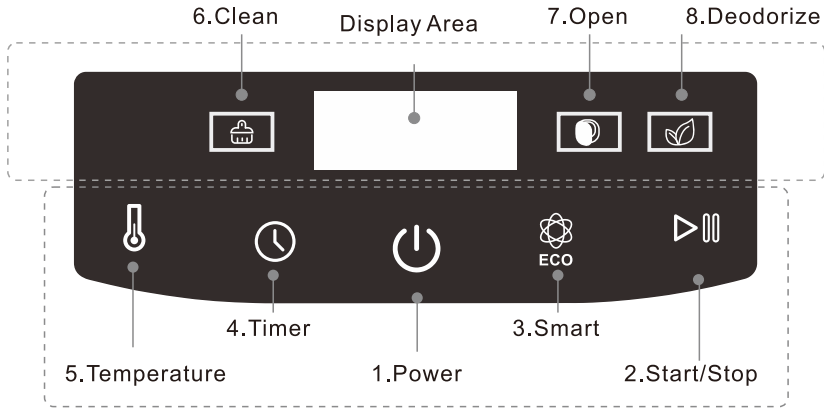

• Clean the interior of the drum or the exterior of the dryer with a damp, soft cloth. If the dirt is difficult to remove, a small amount of kitchen cleaner can be used to wipe, then wipe clean with a dry cloth.



• **Note: Do not use thinners, gasoline, or alcohol to clean the machine.**

Introduction to Control Panel



Button	Function
1.Power 	Press and hold the "Power" button for 0.5 to 1 second to turn on (off) the power.
2.Start/Stop 	Press the "Start/Stop" button and the dryer will start operating 2 seconds later. During operation, pressing this button will pause the dryer.
3.Smart  ECO	The machine intelligently determines the required program based on the condition of the clothing Energy Efficiency Label and the Time in ECO Mode.
4.Timer 	Press the "Timer" button to select from six settings: 20 minutes, 30 minutes, 1 hour, 1 hour and 30 minutes, 2 hours, or 3 hours. Choose the appropriate drying time based on the condition of the clothing.
5.Temperature 	Press the "Temperature" button to select from four different temperature settings: 40°C, 50°C, 60°C, and --°C. When the display shows --°C, it indicates natural air, and this temperature setting can only be displayed and selected when the "Timer" function is activated, followed by pressing the "Temperature" button.
6.Clean 	When this light flashes, it is a reminder to clean the filter.
7.Open 	This light indicates that the door needs to be closed, and pressing the start button again will continue the operation.
8.Deodorize 	Select any temperature and set a drying time of 30 minutes or less, and deodorizing will be applied to the clothing, indicated by this light.

• **Note:** Press and hold the power button for 0.5 to 1 second to turn on the power. Press the start button to begin default operation of the smart program!

Common Troubleshooting

If the dryer malfunctions, please disconnect the power cord from the power source before checking. In the following cases, sometimes it is not a malfunction. Before repairing, please reconfirm. If it is a malfunction, please contact our after-sales service department by dialing our nationwide customer service hotline. Do not attempt to repair it yourself.

Abnormal Phenomenon	Abnormal Cause	Solutions
Dryer Not Starting	<ul style="list-style-type: none"> • Check if there is a power outage or a circuit breaker trip. • Ensure that the power connection is secure and tight. • Check if the drying load exceeds the dryer's capacity. • Verify that the temperature controller is not disconnected 	<ul style="list-style-type: none"> • Resume use after power restoration. • Check the power connection to ensure it is securely fastened. • Clothes must be properly dehydrated before loading, and the drying weight (weight of wet clothes) should not exceed 5.0kg. Have a maintenance technician replace the temperature controller.
Dryer Externally Heating Up or Smelling Hot	<ul style="list-style-type: none"> • The lint filter's mesh is clogged with fluff. • The exhaust outlet or vent duct is blocked. 	<ul style="list-style-type: none"> • Clean the lint filter of any lint before and after each use. Clear any blockages.
The clothes are difficult to dry	<ul style="list-style-type: none"> • The clothes inside the machine are too full • The filter is blocked, affecting airflow in and out • The clothes are too full, causing tangling • The machine is installed in a narrow, poorly ventilated location. 	<ul style="list-style-type: none"> • Dry clothes in multiple batches. • Regularly clean the inlet and outlet air filters. • Shake out clothes and dry them again. • Rearrange the machine.
Excessive wrinkles on clothing	<ul style="list-style-type: none"> • The clothes inside the machine are too full • The clothes were not removed promptly after the cycle ended • The clothes were not properly sorted • The temperature was set too high. 	<ul style="list-style-type: none"> • Do not overfill the dryer with clothes. • Remove clothes immediately after the cycle ends. • Sort clothes before drying. • Follow the care instructions on the clothing labels.
Clothing shrinkage	<ul style="list-style-type: none"> • Excessive Drying 	<ul style="list-style-type: none"> • Follow the care label instructions on the clothing. If this garment is prone to shrinking, check it frequently during drying. Remove the clothing while it is still slightly damp to avoid over-drying, and then hang or lay the clothing flat to allow it to dry completely.

Clothing Has Lint Ball	<ul style="list-style-type: none"> Lint balls formed from synthetic fibers and wrinkle-free fibers are normal, as they are caused by normal friction. 	<ul style="list-style-type: none"> Use fabric softener to soften fibers. When ironing clothes, spray starch on the collar and cuffs. Alternatively, turn the garment inside out to reduce friction.
The machine exhibits a failure to start after prolonged operation.	<ul style="list-style-type: none"> The drum inside the machine experiences an overheating protection shutdown after prolonged operation. 	<ul style="list-style-type: none"> The machine will automatically reset and resume normal operation after about 30 minutes of automatic protection.

Fault Alarm Handling

Fault Display	Fault Cause	Fault Phenomenon	Buzzer Alarm	Fault Resolution
Door Open Alarm	Door opened after program start.	“Open door” indicator light flickers	With buzzer alarm	Close the door to resolve the fault.
Communication Fault	Circuit Fault or Connector Fault	E1 indicator light flickers	With buzzer alarm	inspect the connector.
Temperature sensor malfunction	Circuit Fault.	E2 indicator light flickers	With buzzer alarm	Replace the temperatures ensor.

Product Specifications

Specifications Model	Exterior size	Product weight	Rated drying capacity	Rated input power	Rated voltage /frequency
1	480×400×560mm	14.5kg	4.0kg	800W	220-240V~50-60Hz
Off mode power			P _o	0.5	W
Standby mode power			P _{so}	[N/A]	W
Power management function			[N/A]		
Time to enter automatically off mode			T _o	[N/A]	Min
Time to enter automatically standby mode			T _{so}	[N/A]	Min

Packaging List

Model	Whole machine	Manual	Air outlet tube
B61-016V70	1 unit	1 piece	1 piece