

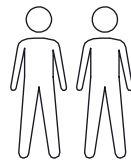

1 : 30

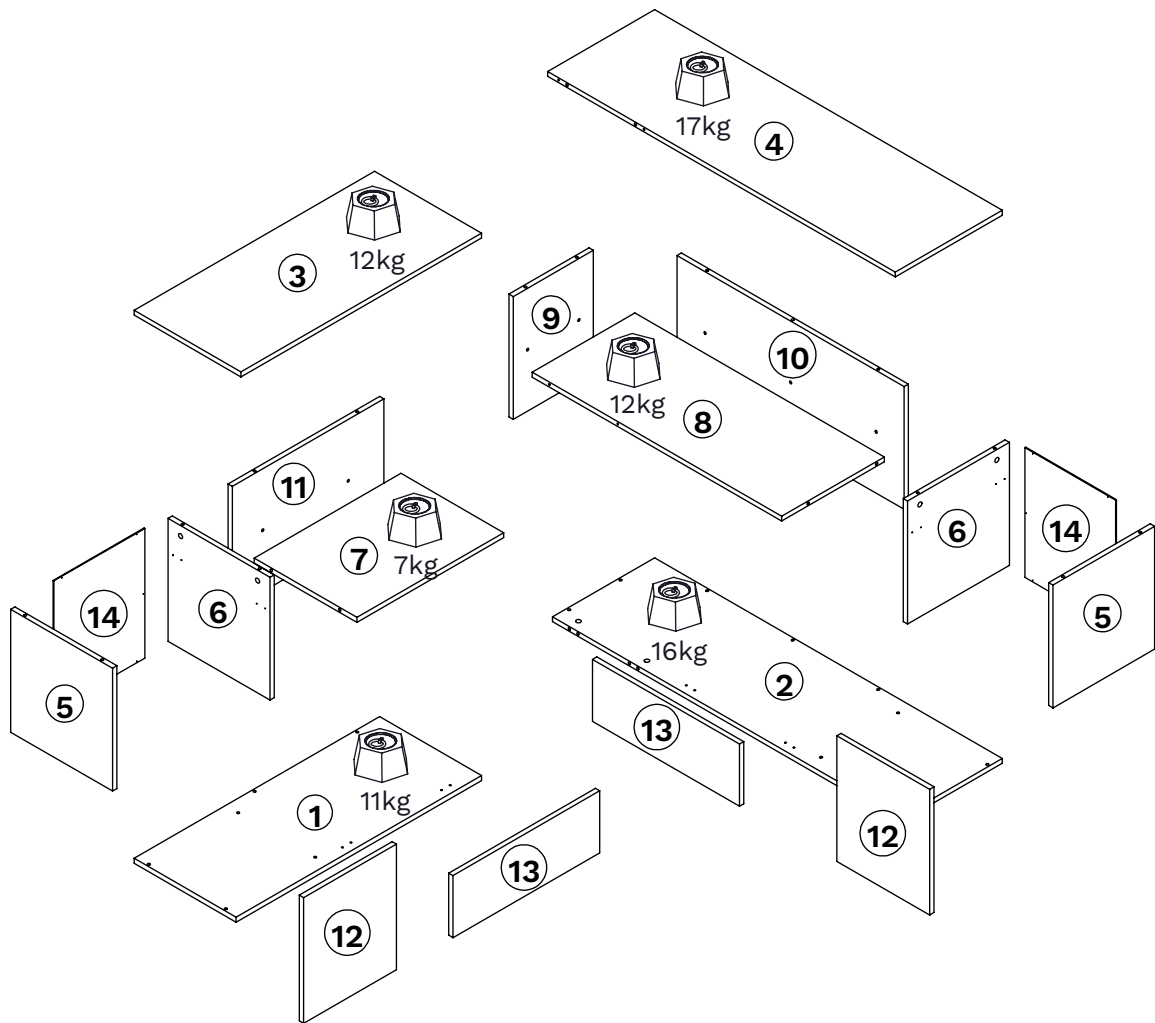

x 2



○	x	mm	
1	1	918 x 382 x 16	1
2	1	1300 x 382 x 16	1
3	1	900 x 400 x 16	2
4	1	1300 x 400 x 16	1
5	2	398 x 381 x 16	1
6	2	398 x 381 x 16	1
7	1	549 x 384 x 16	2
8	1	933 x 384 x 16	2
9	1	300 x 398 x 16	2
10	1	850 x 398 x 16	2
11	1	567 x 398 x 16	2
12	2	407 x 347 x 16	1
13	2	549 x 201 x 16	1
14	2	420 x 340 x 3	1

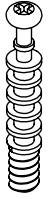
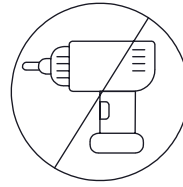
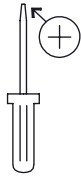

Ø7 x 41mm

BA x 23



AA x 23

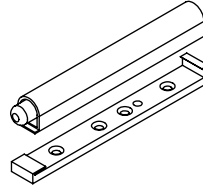

OY x 4



Ø3 x 12mm

GA x 8

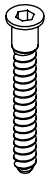

Ø6,3 x 50mm

CA x 22

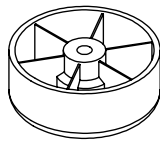

RN x 6

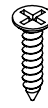

Ø4 x 20mm

IB x 6



NK x 12

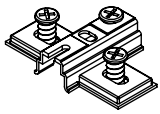

KL x 8

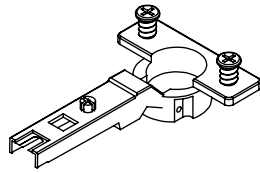

KA x 8





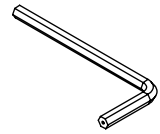

DAB x 4

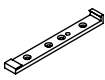

CLE x 1

1

AA x9 	BA x2  Ø7x41mm	OY x2 	GA x4  Ø3x12mm
--	---	--	---

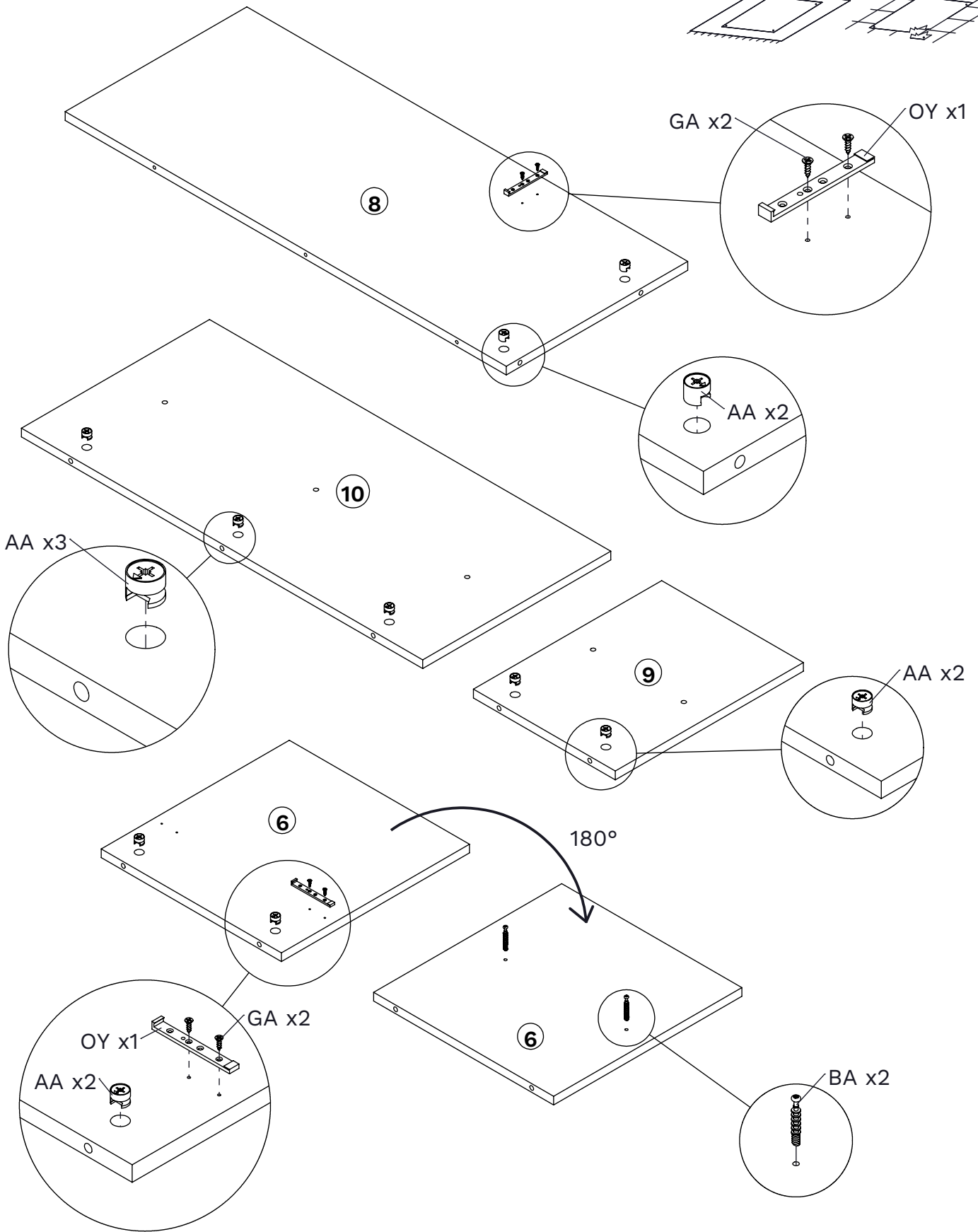
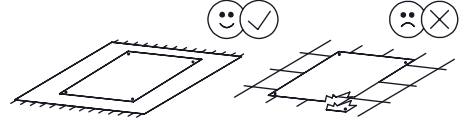
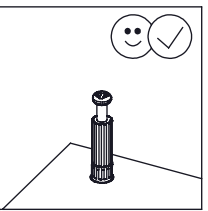
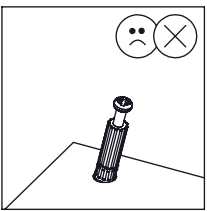
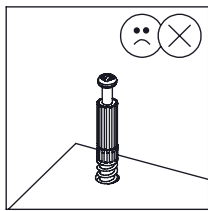
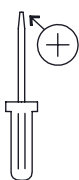

2

CA x5

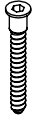

Ø6,3x50mm

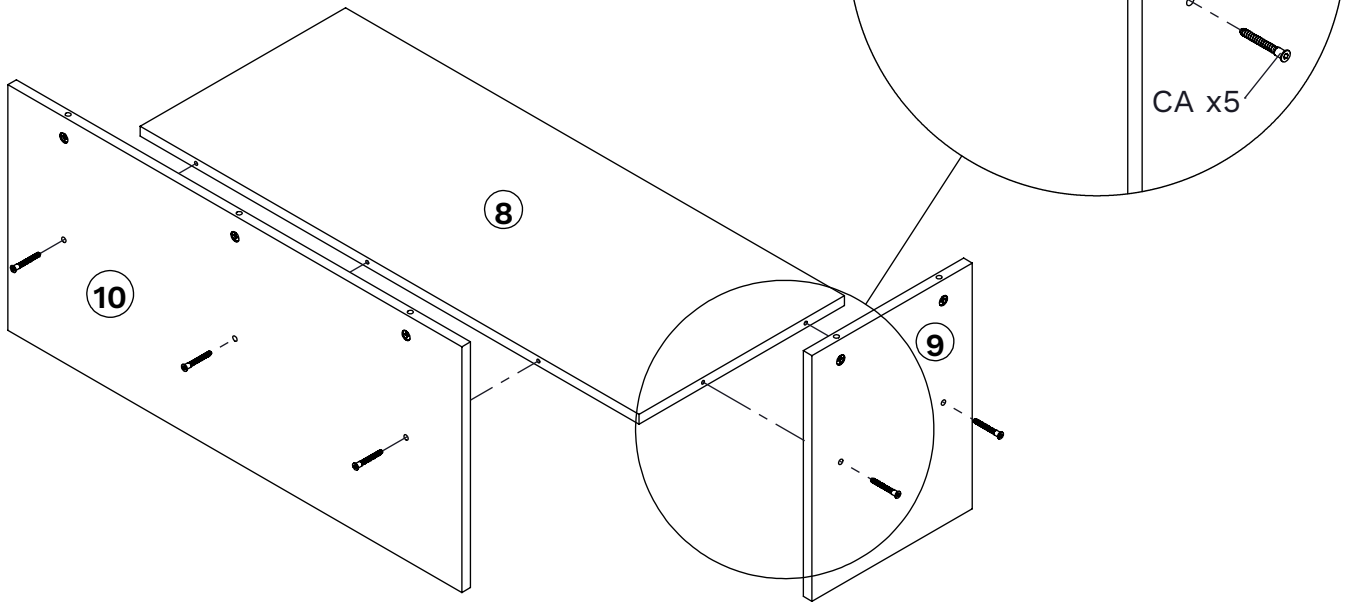
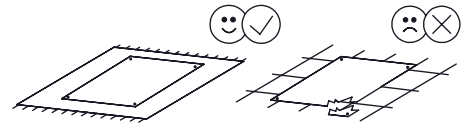

CLE x1

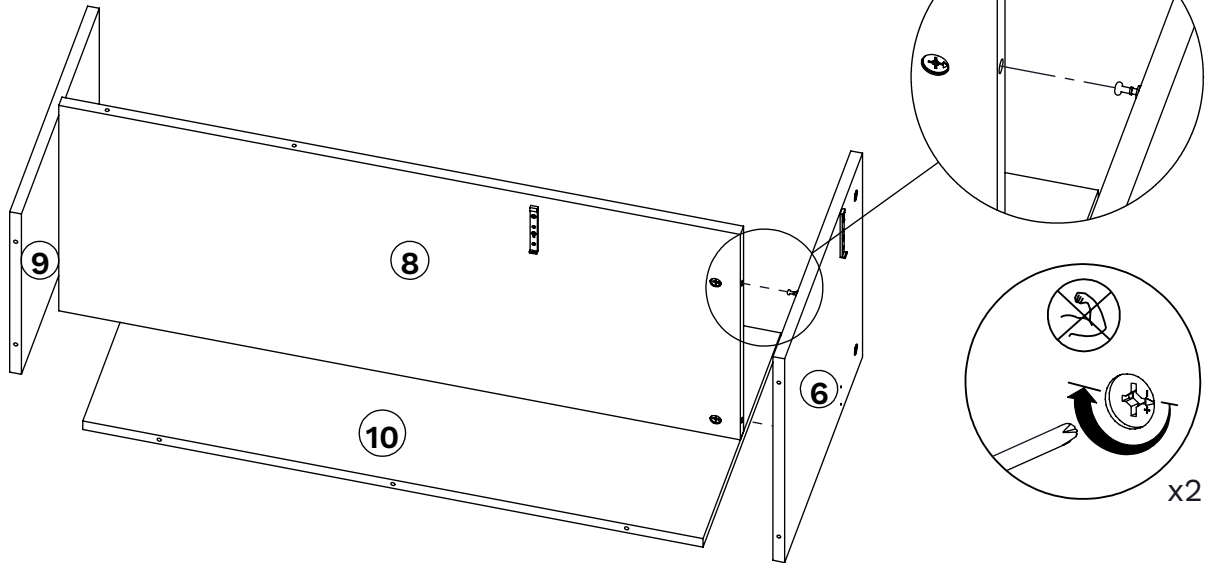
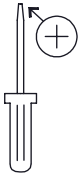

3



4



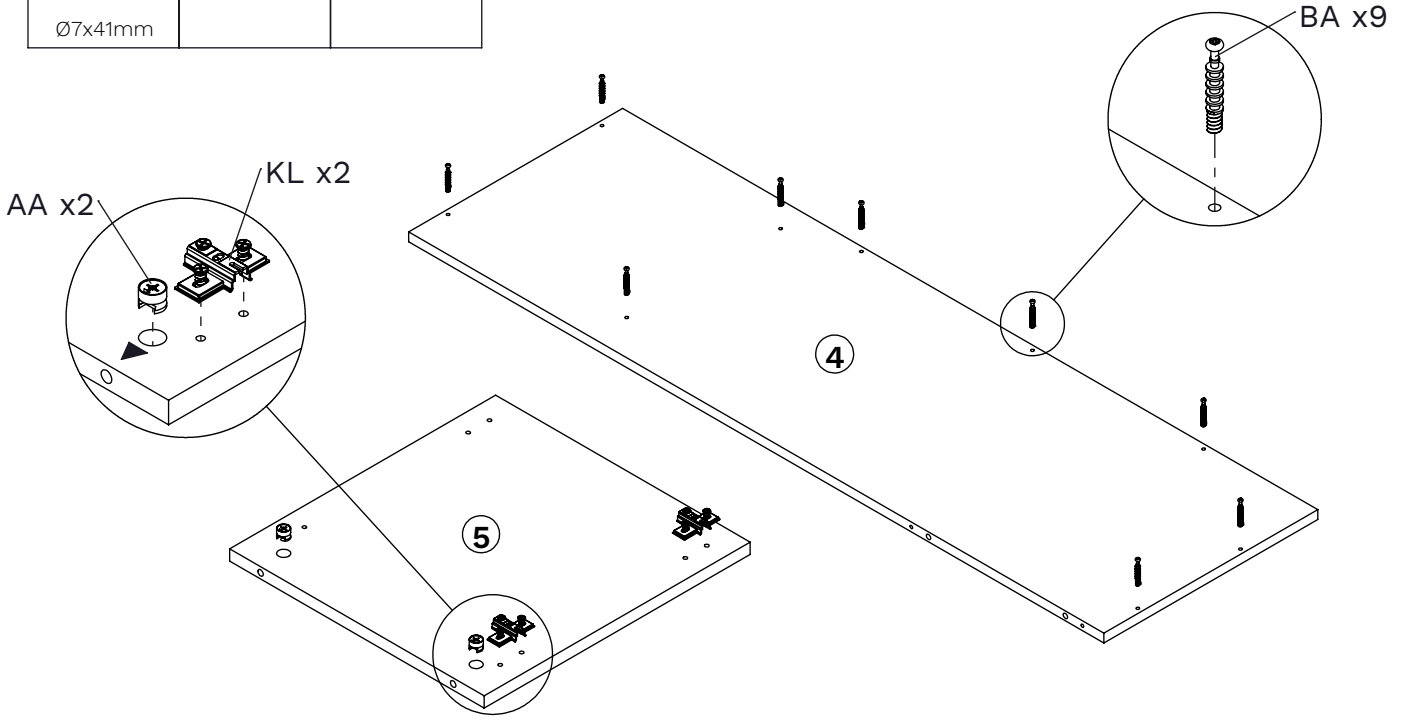
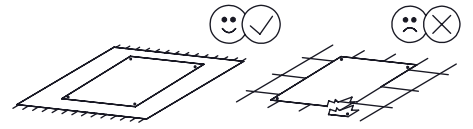

BA x9  Ø7x41mm	AA x2 	KL x2 
---	--	--

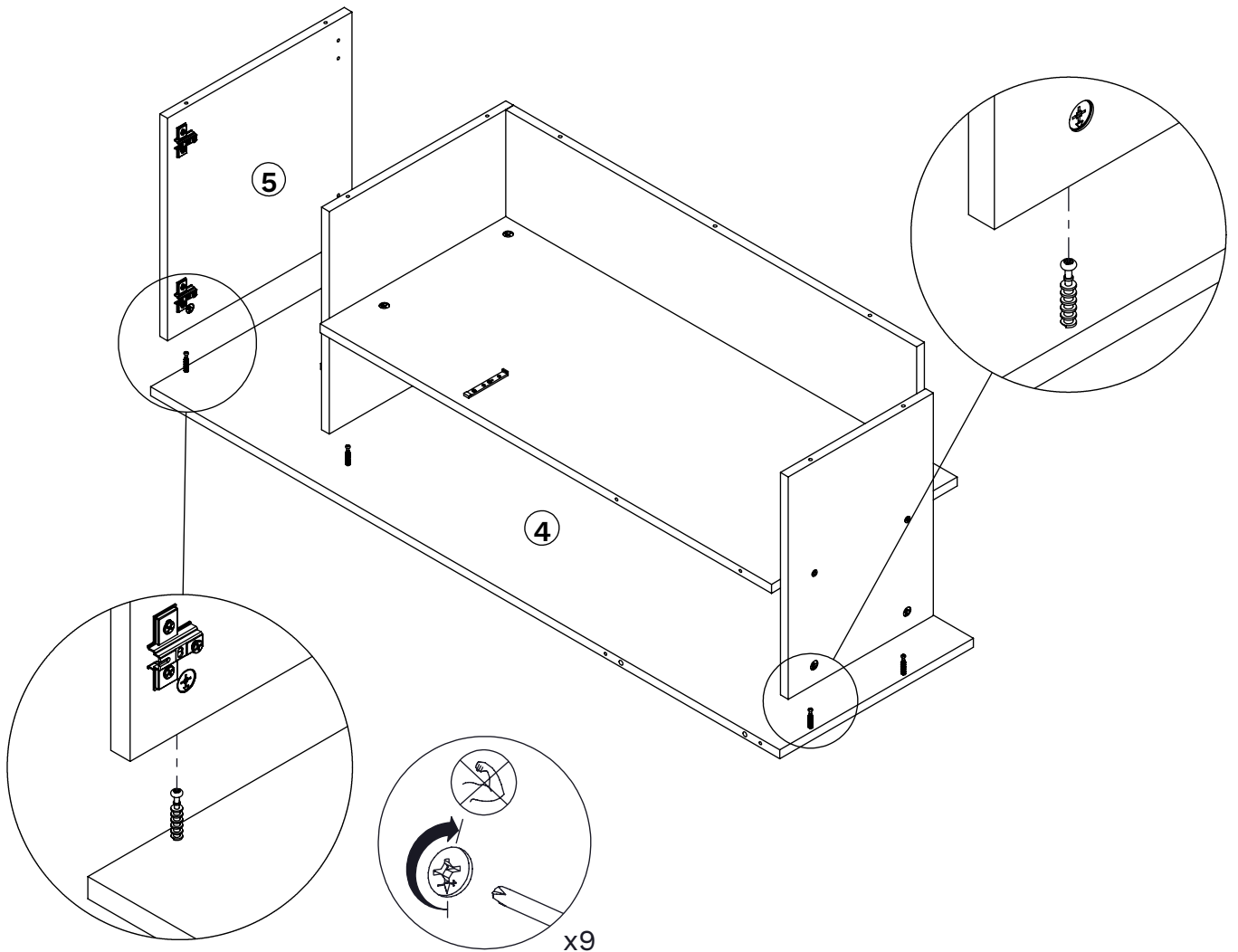

5



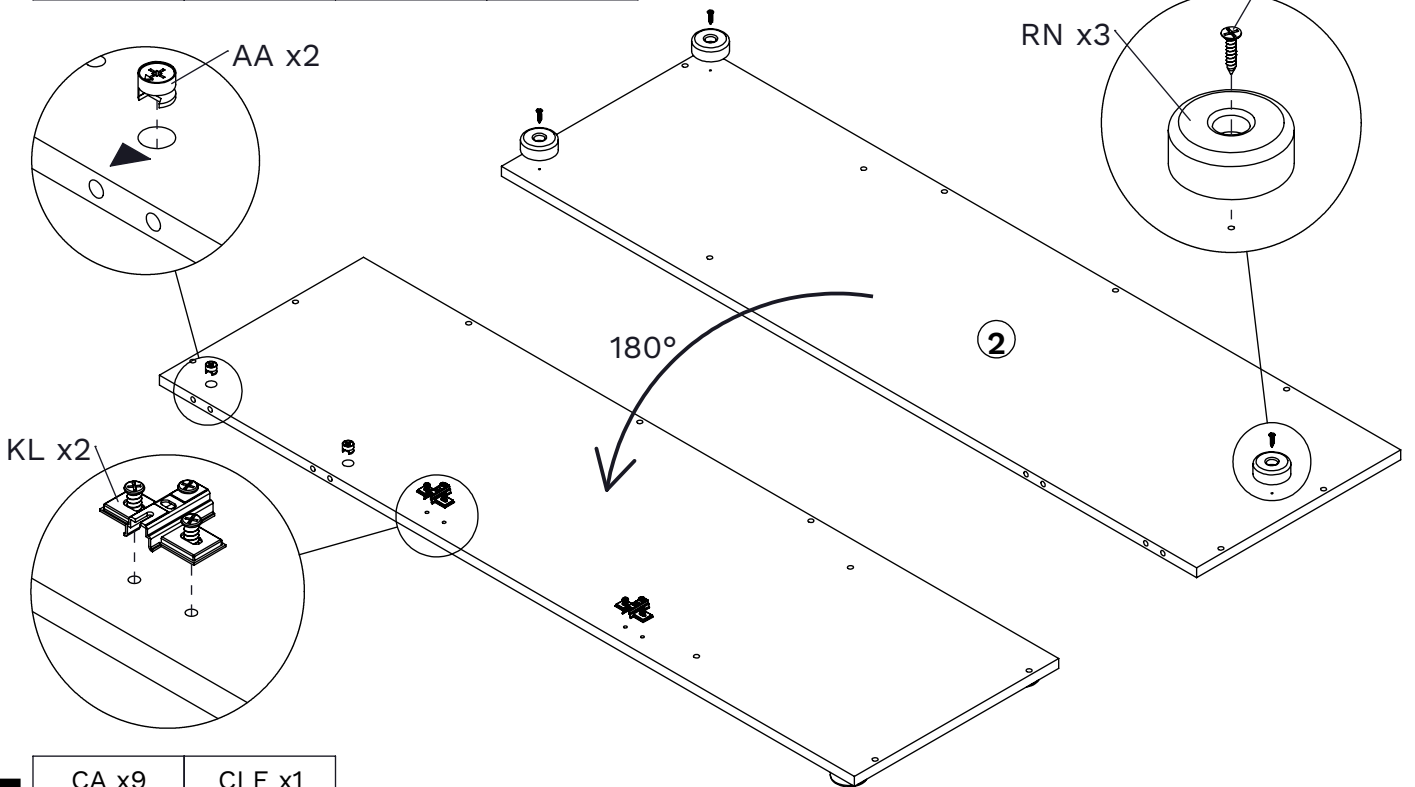
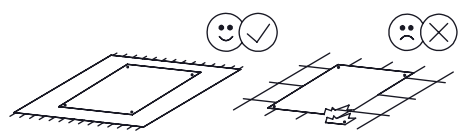

6

AA x2 	KL x2 	RN x3 	IB x3  Ø4x20mm
--	--	--	---

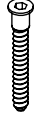

7

CA x9  Ø6,3x50mm	CLE x1 
---	---

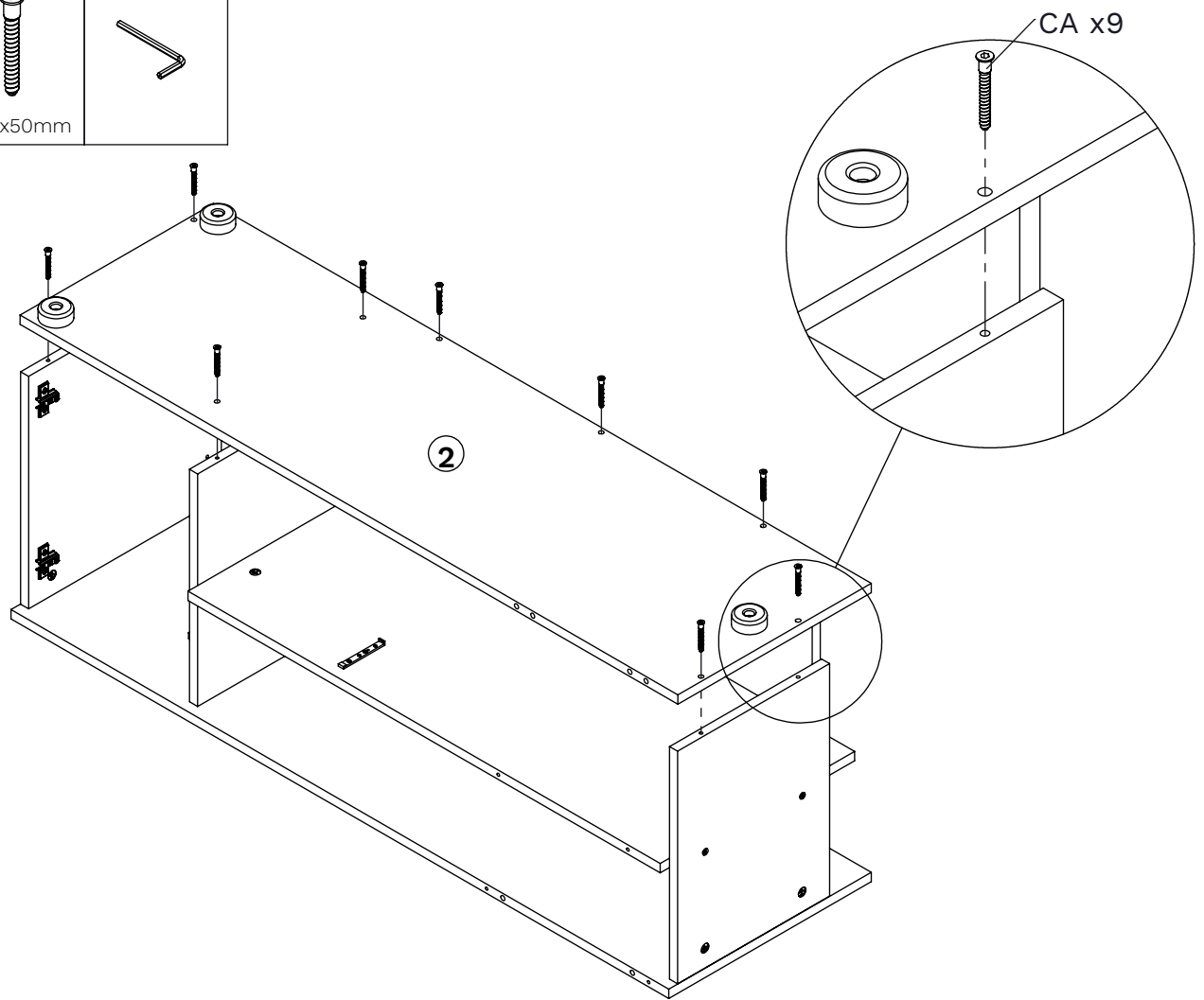

8

NK x6

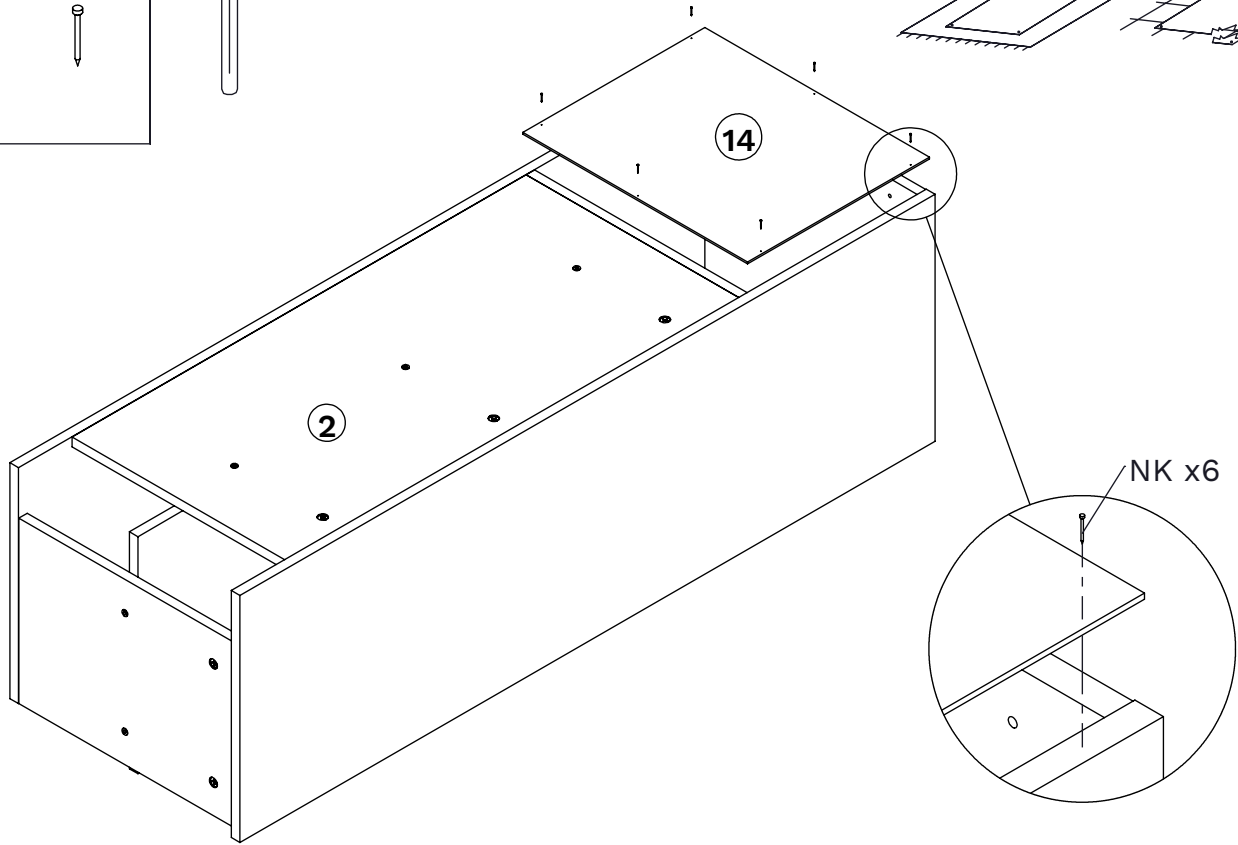
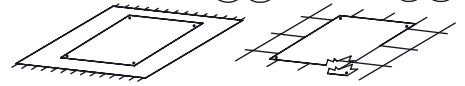
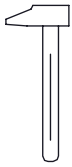

9

KA x4

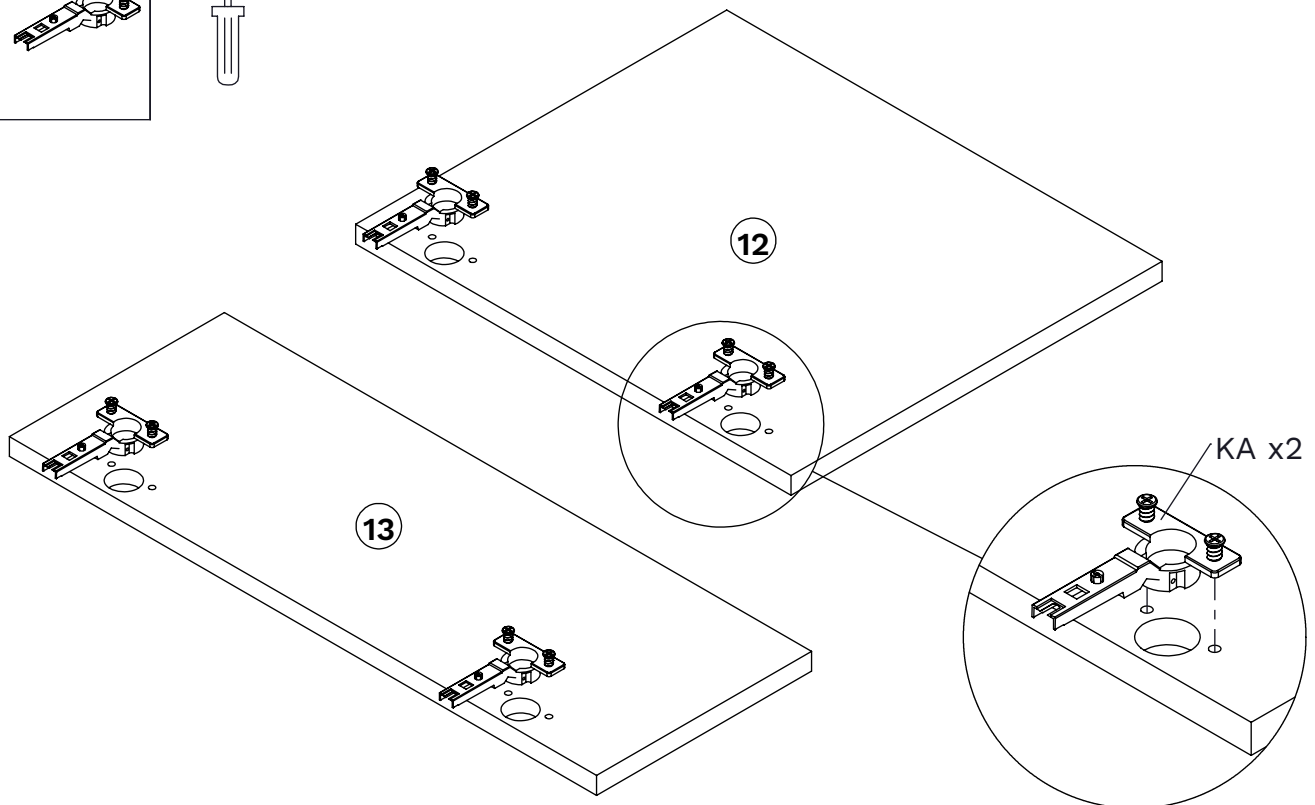
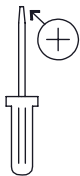
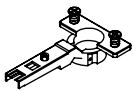



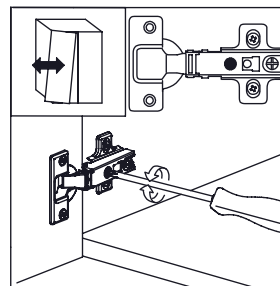
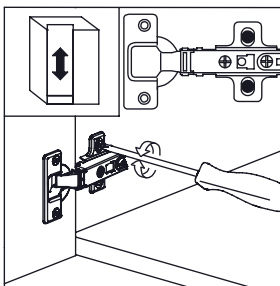
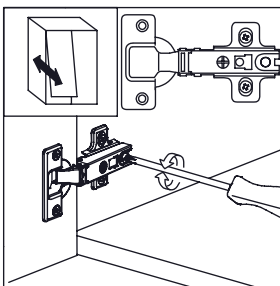
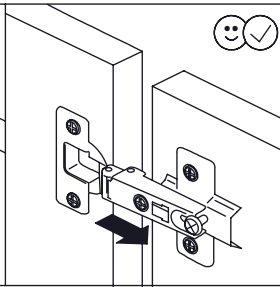
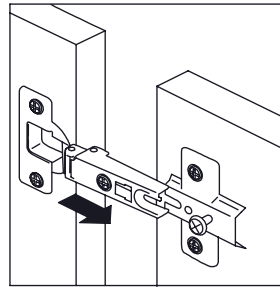
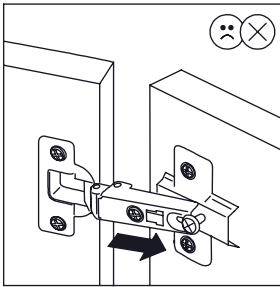
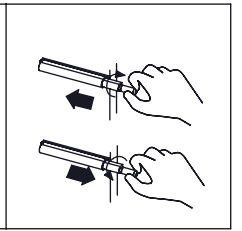
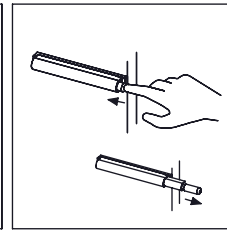
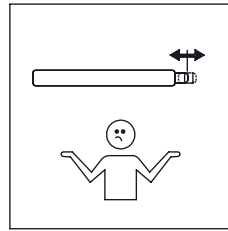
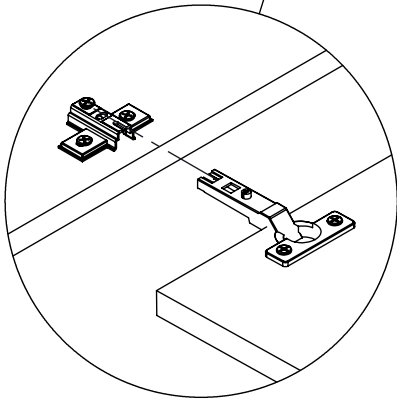
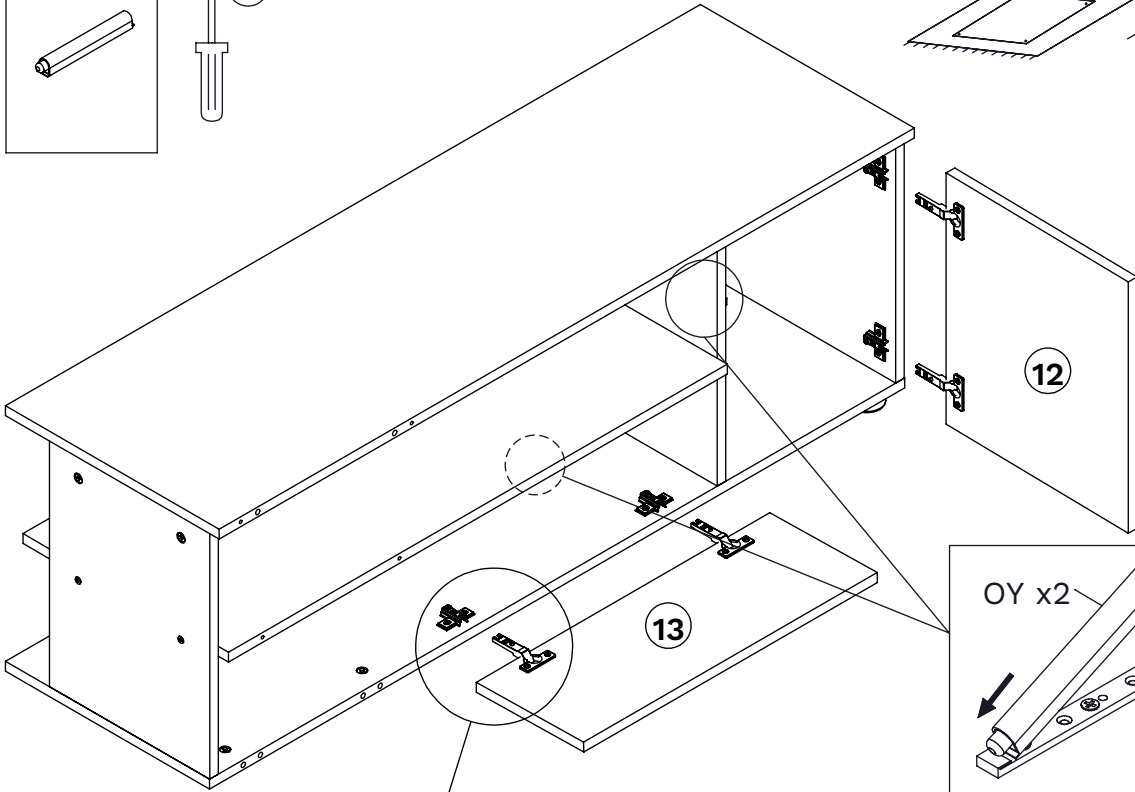
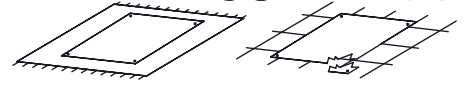
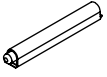

10

OY x2



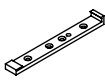

11

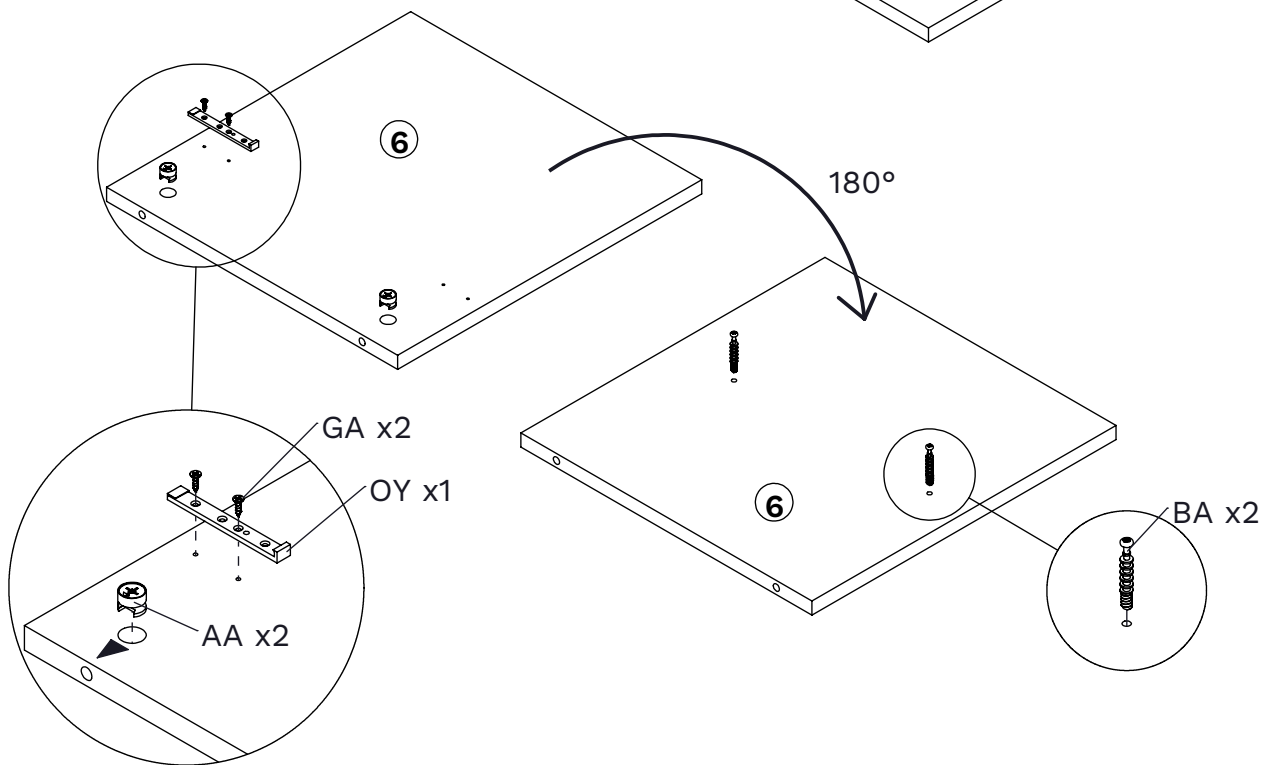
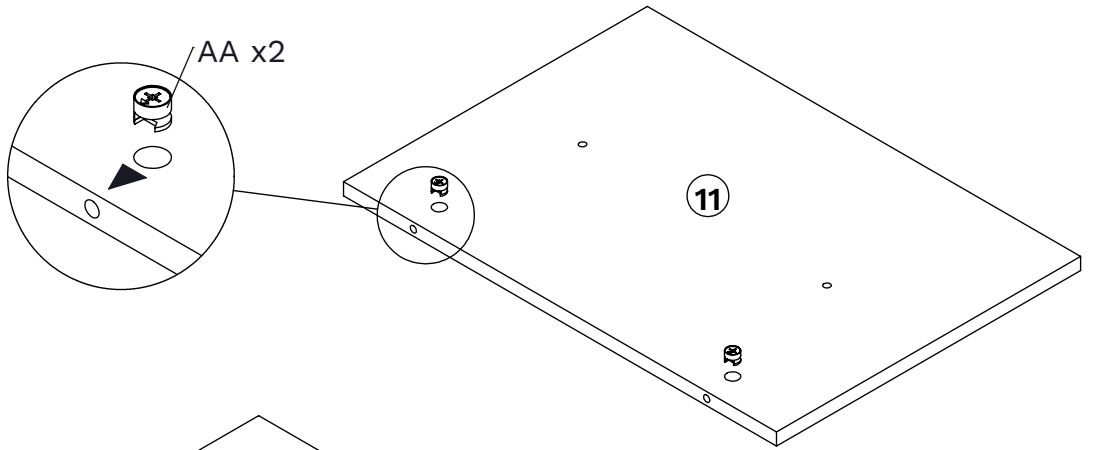
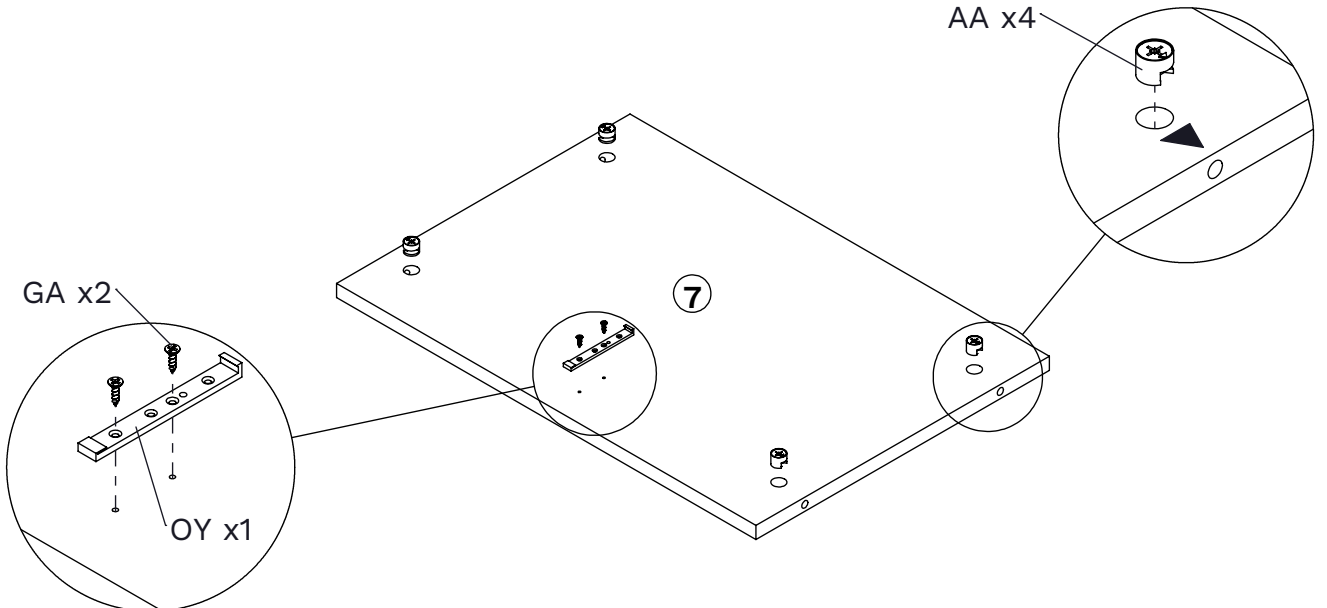
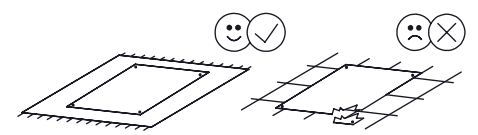
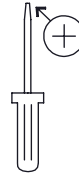
AA x8 	BA x2  Ø7x41mm	OY x2 	GA x4  Ø3x12mm
--	---	--	---



14

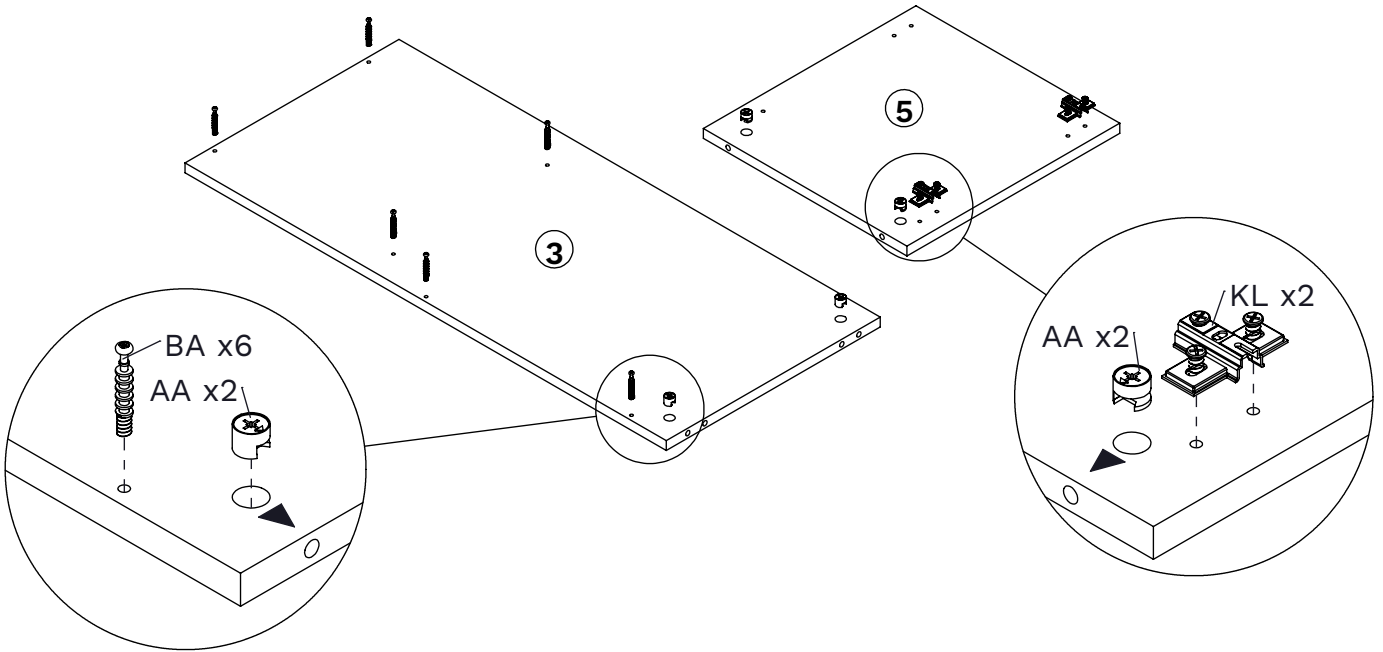
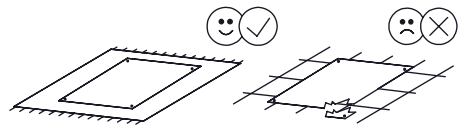
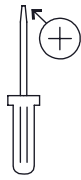

AA x4 	BA x6  Ø7x41mm	KL x2 
--	---	--

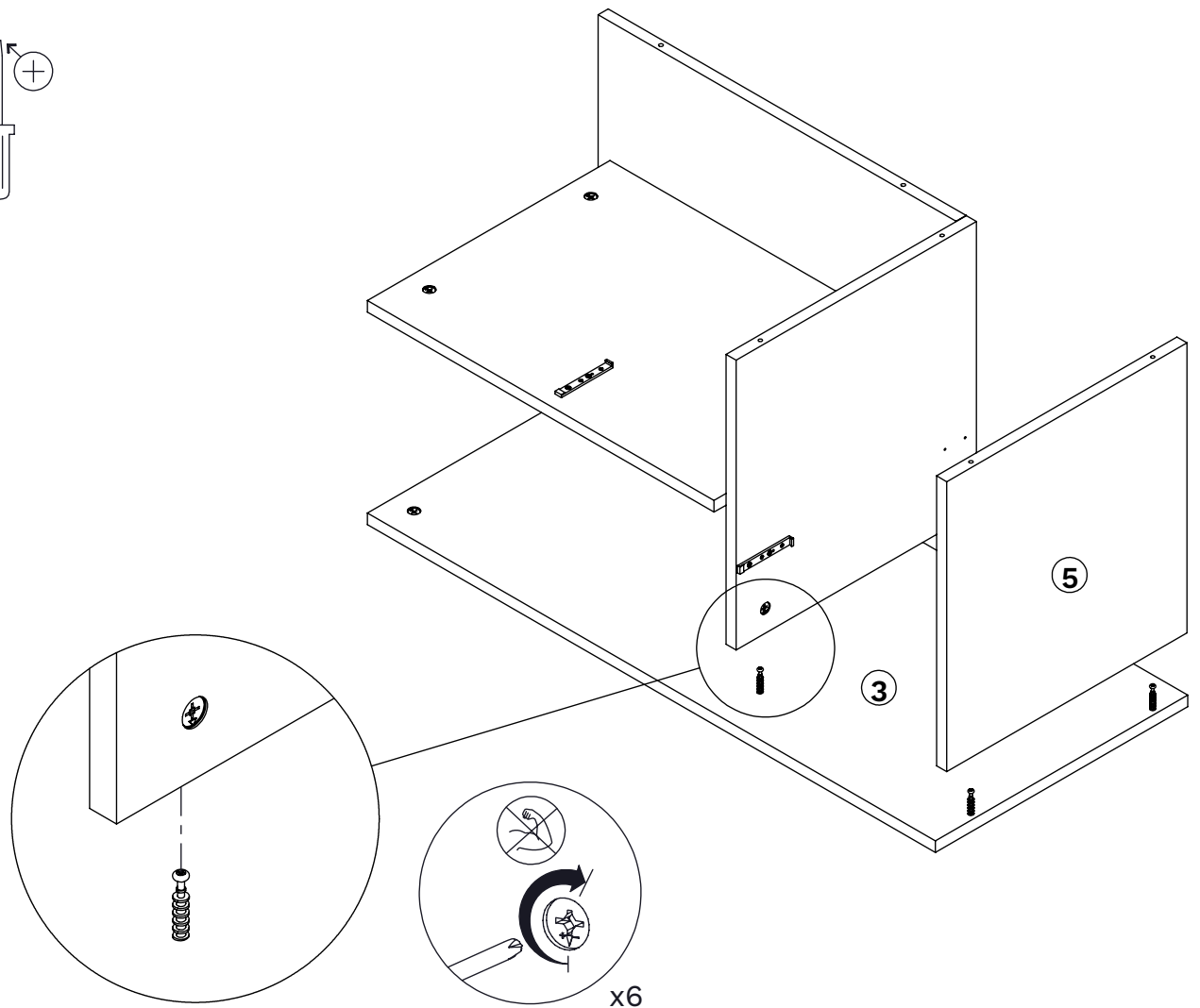
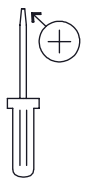

15



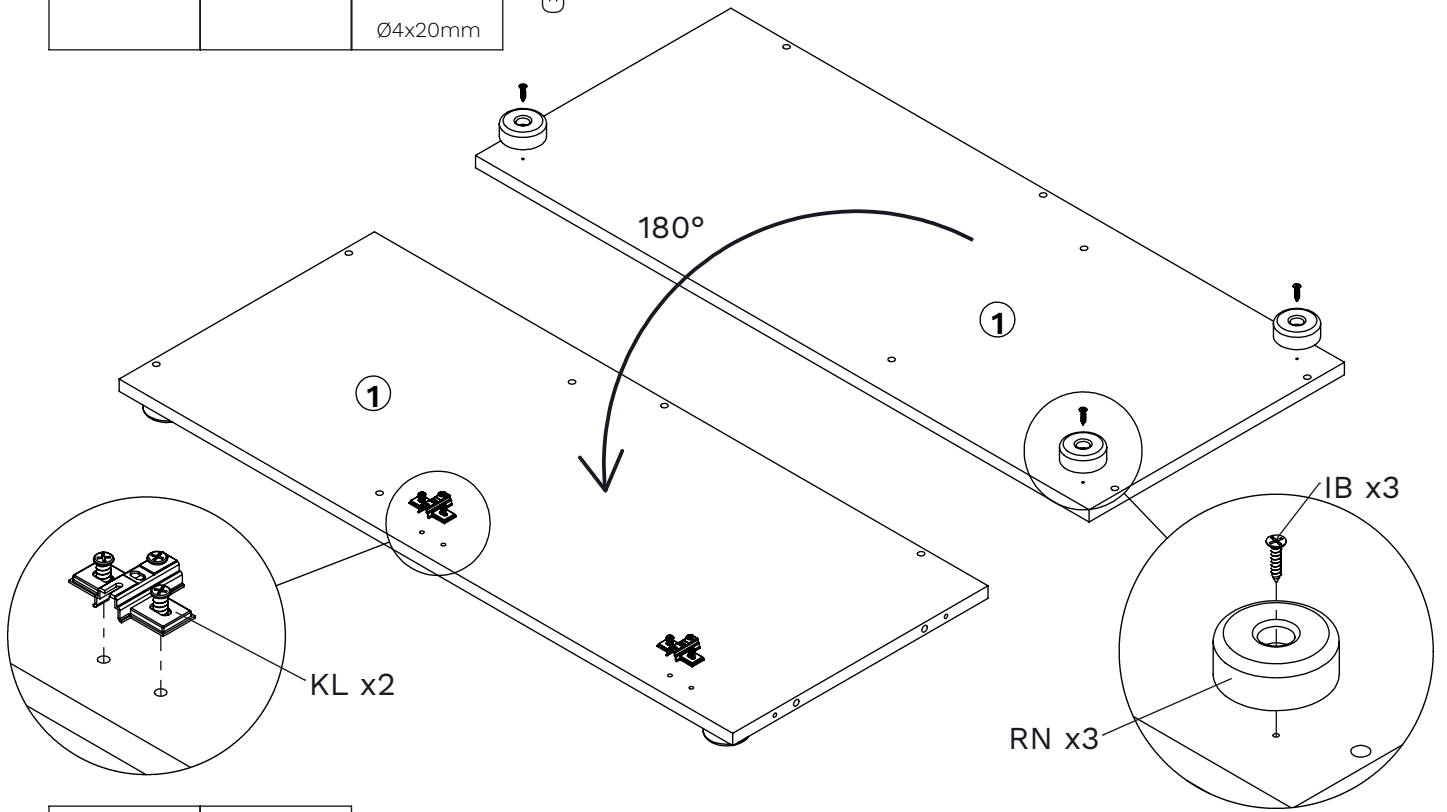
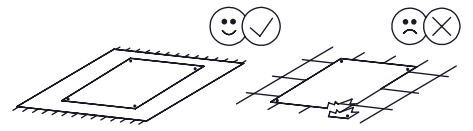
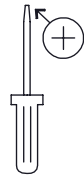

16

KL x2 	RN x3 	IB x3  Ø4x20mm
--	--	---

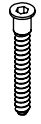

17

CA x6  Ø6,3x50mm	CLE x1 
---	---

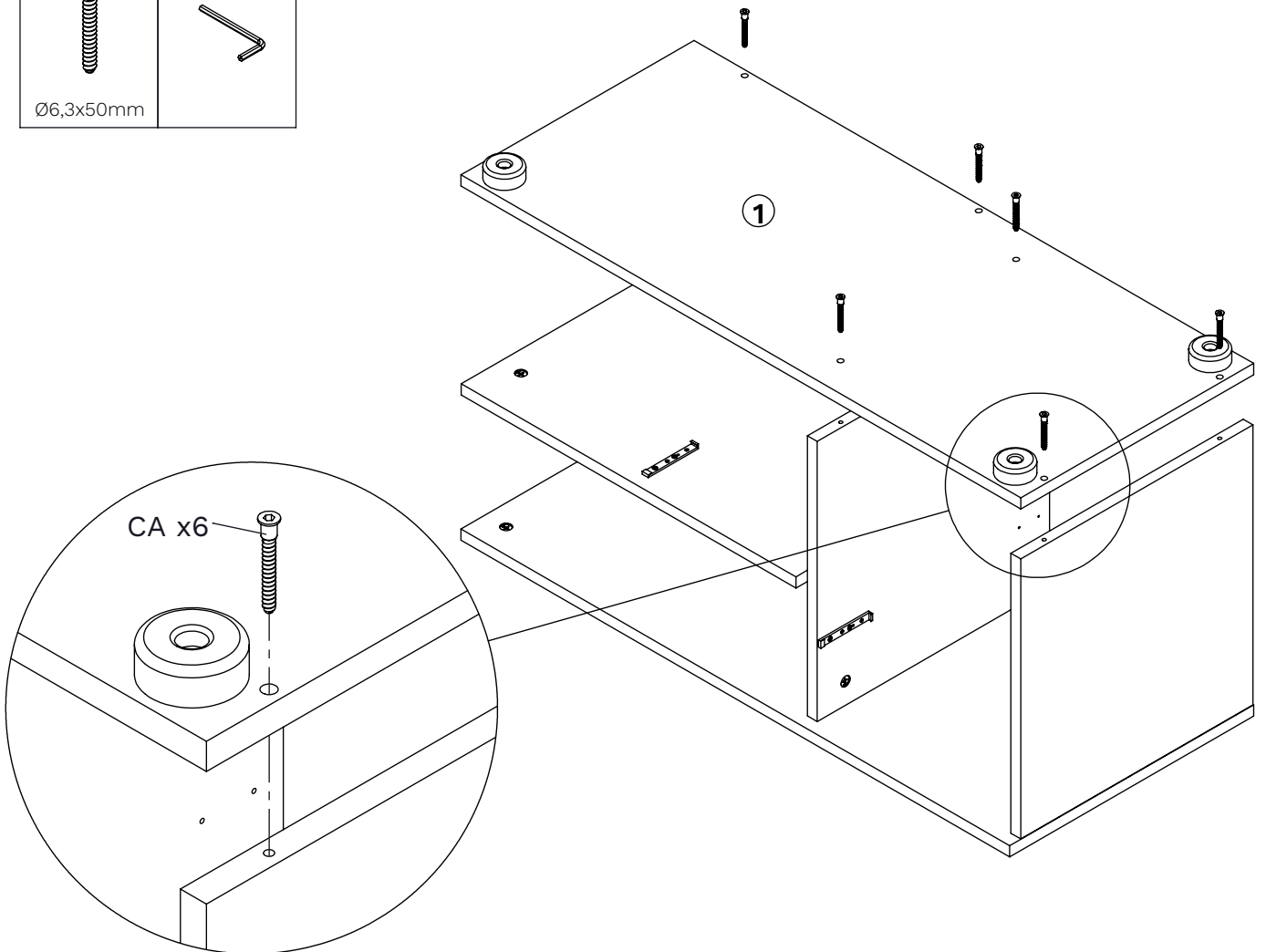

18

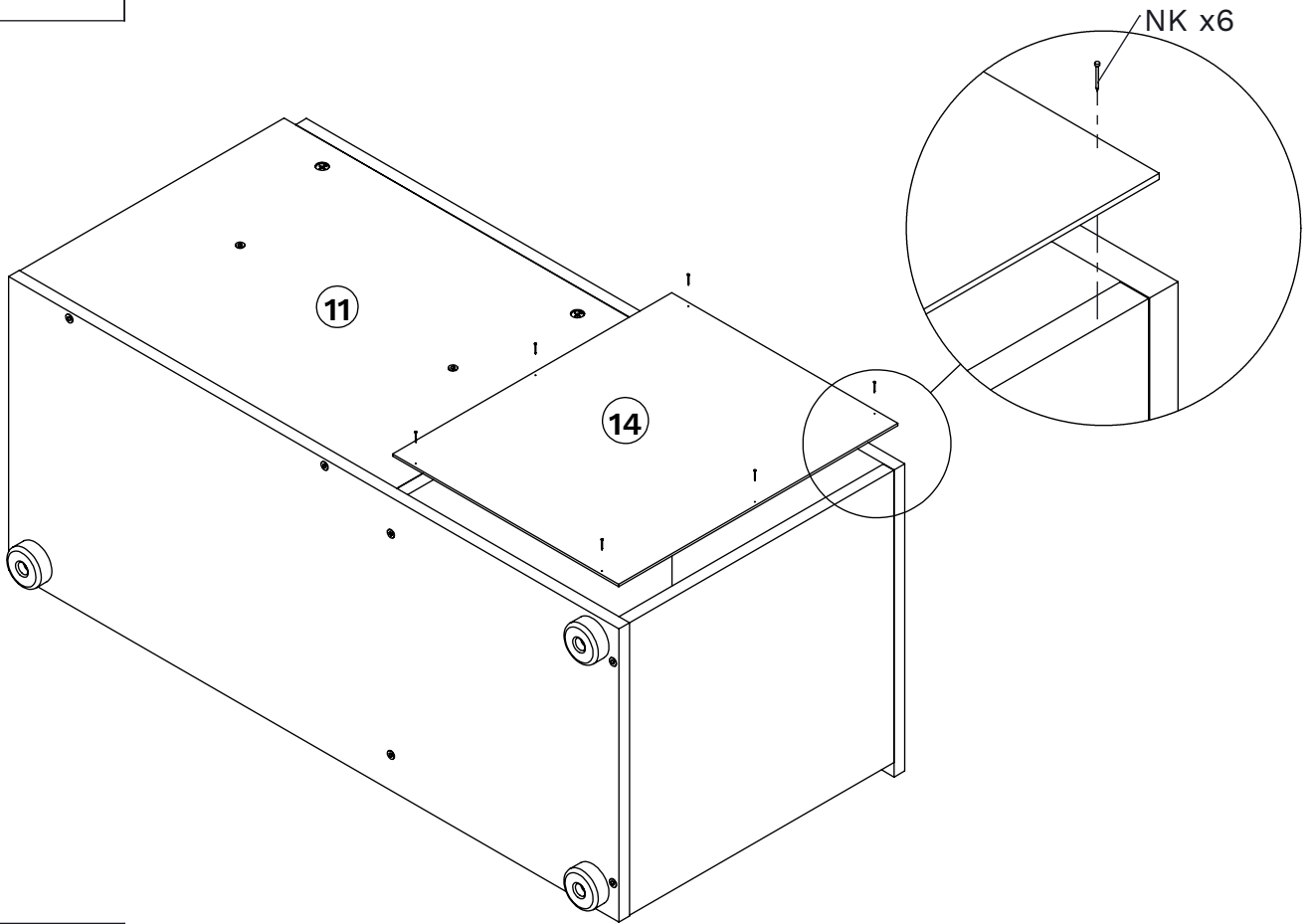
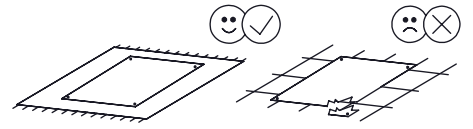
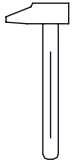
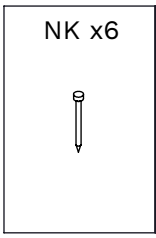

19

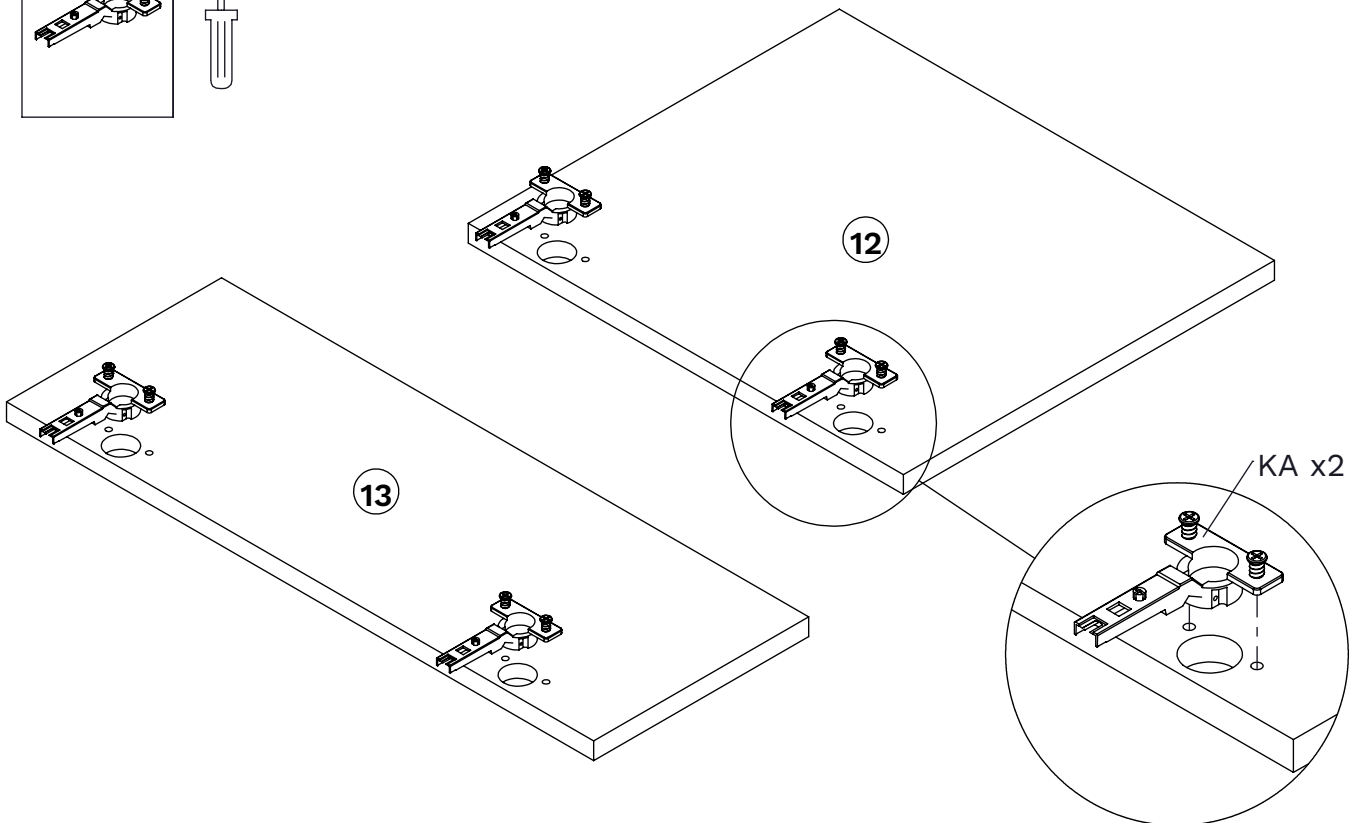
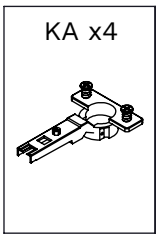

20

OY x2

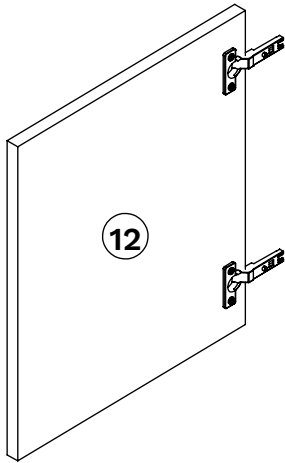
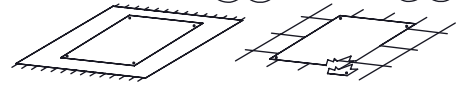
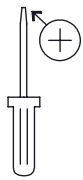
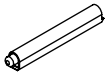

12

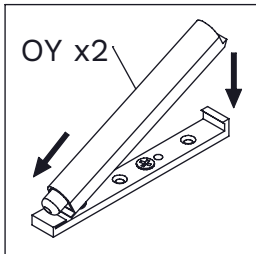
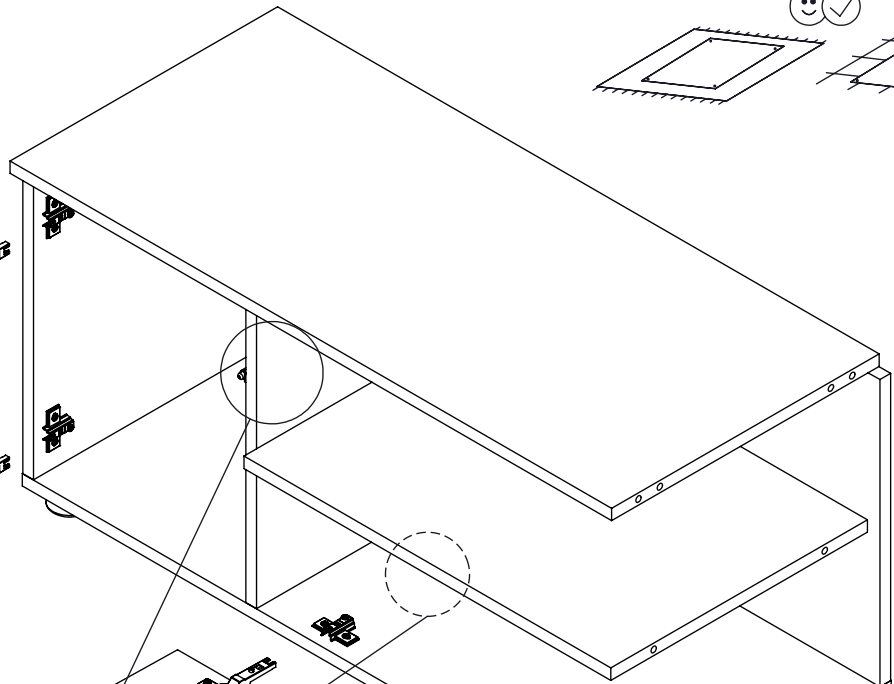

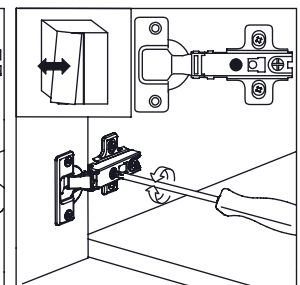
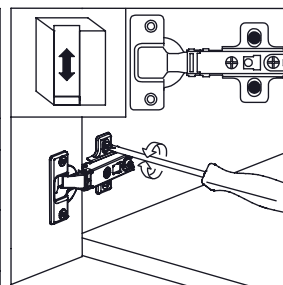
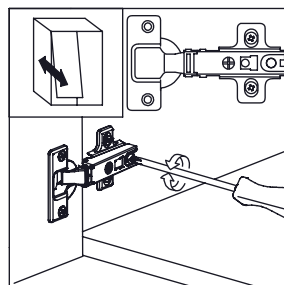
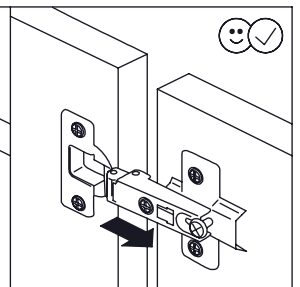
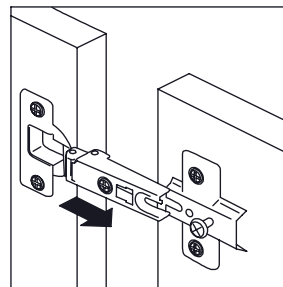
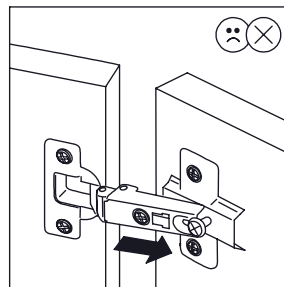
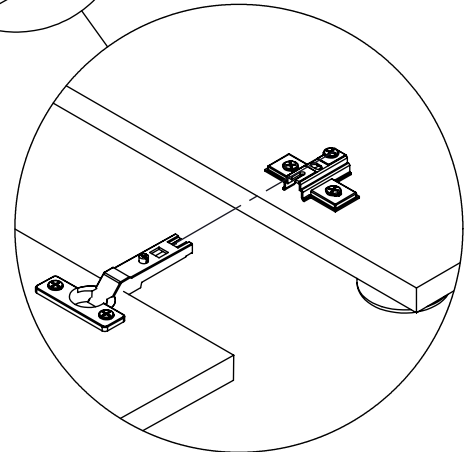
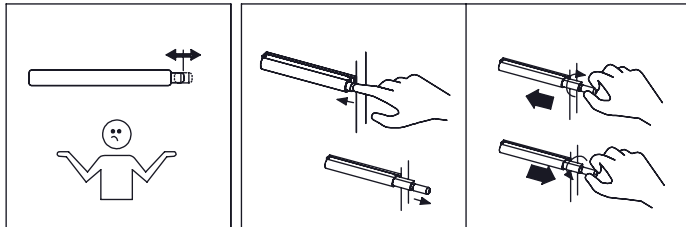

OY x2

13



21

BA x6  Ø7x41mm	DAB x4 
---	---

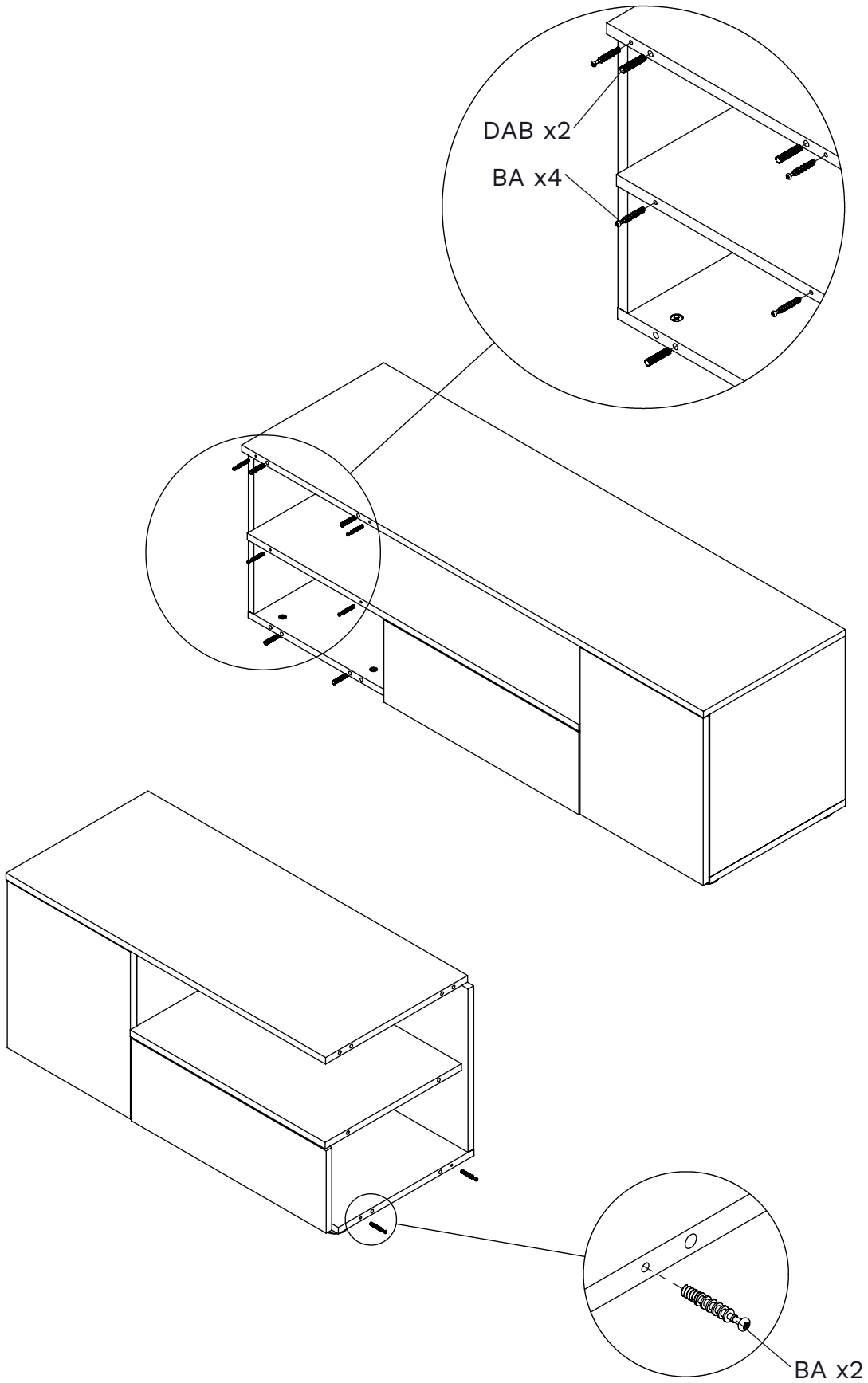
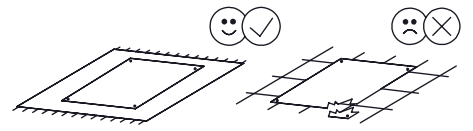
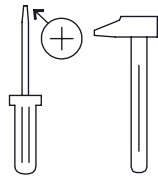

22

