

ASSEMBLY INSTRUCTION

PENDANT LIGHT

A Lamp

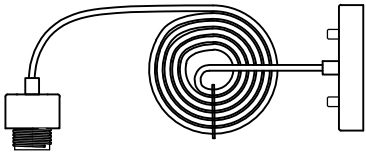

1pc

B Lamp Shade
Ø220x217mm



1pc

C Lampholder Ring
Ø61x5.5mm



1pc

D Accessory
Ø10x12mm



2pcs

E Washer
Ø12xØ4.5x1mm



2pcs

F Screw
5/32"-32Tx25mm



2pcs

G Wire Connector
Ø10x18mm



2pcs

H Wire Connector
Ø8x15mm



1pc

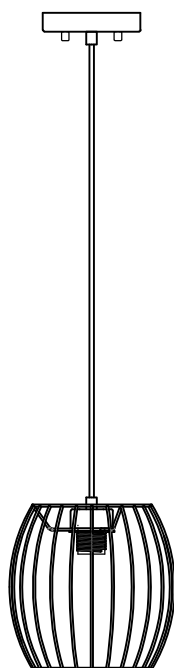

IMPORTANT SAFETY INSTRUCTIONS

THIS PENDANT LAMP HAS A POLARIZED PLUG (ONE BLADE IS WIDER THAN THE OTHER). AS A SAFETY FEATURE TO REDUCE THE RISK OF ELECTRIC SHOCK. THIS PLUG WILL FIT IN A POLARIZED OUTLET ONLY ONE WAY. IF THE PLUG DOES NOT FIT FULLY IN THE OUTLET, REVERSE THE PLUG. IF IT STILL DOES NOT FIT, CONTACT A QUALIFIED ELECTRICIAN. NEVER USE WITH AN EXTENSION CORD UNLESS PLUG CAN BE FULLY INSERTED. DO NOT ALTER THE PLUG.

This page lists all the contents included in the box. Please take the time to identify the hardware as well as the individual components to this product. As you unpack and prepare for assembly, place the contents on a carpeted or padded area to protect them from damage.

1 Take out the Accessory (D) from the ceiling base of Lamp (A).

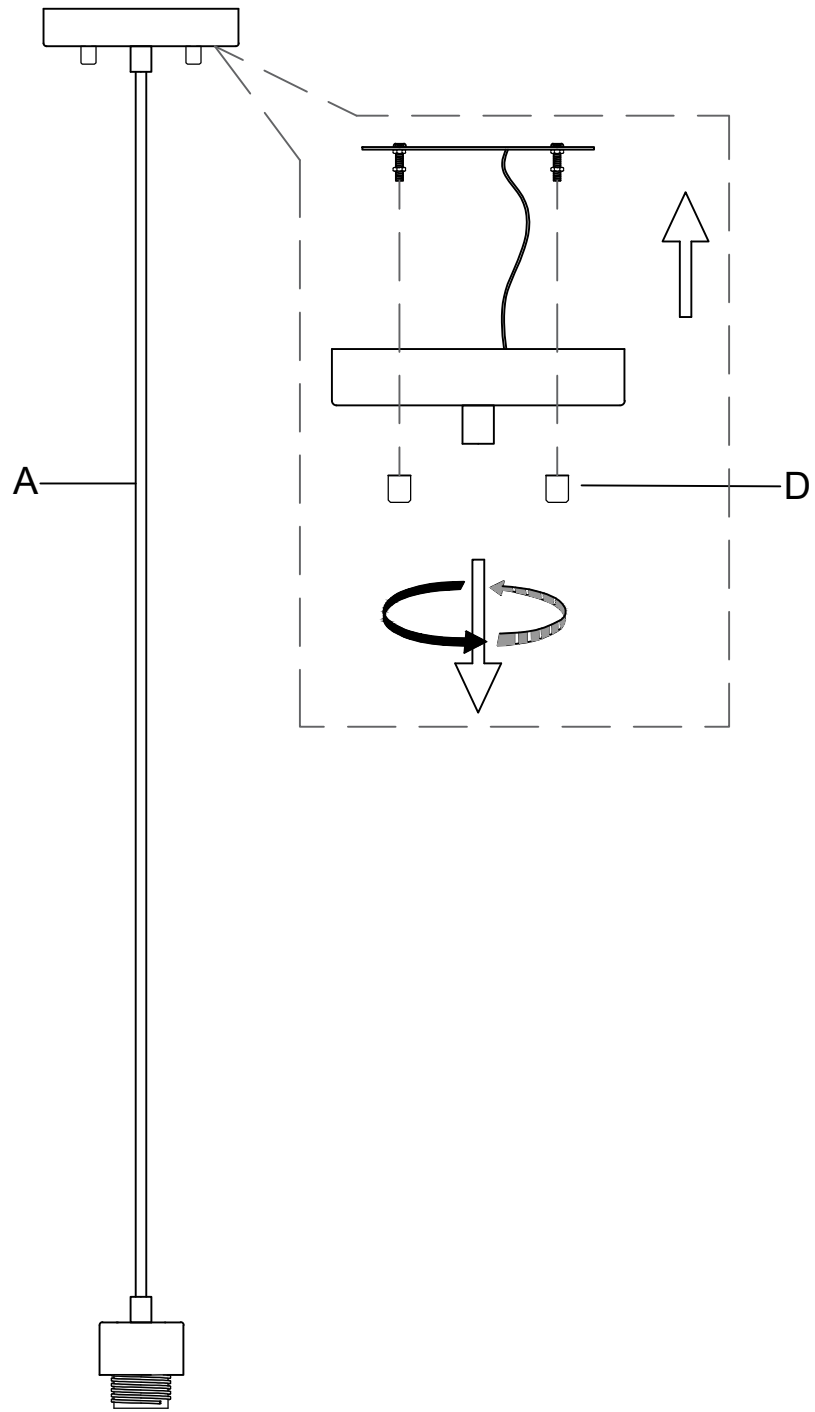

2

Firstly, connect the Wire Connector (G) and (H) together with wire and then fix the bracket on the ceiling with Screw (F) and Washer (E). Secondly, use Accessory (D) to fix the ceiling base.

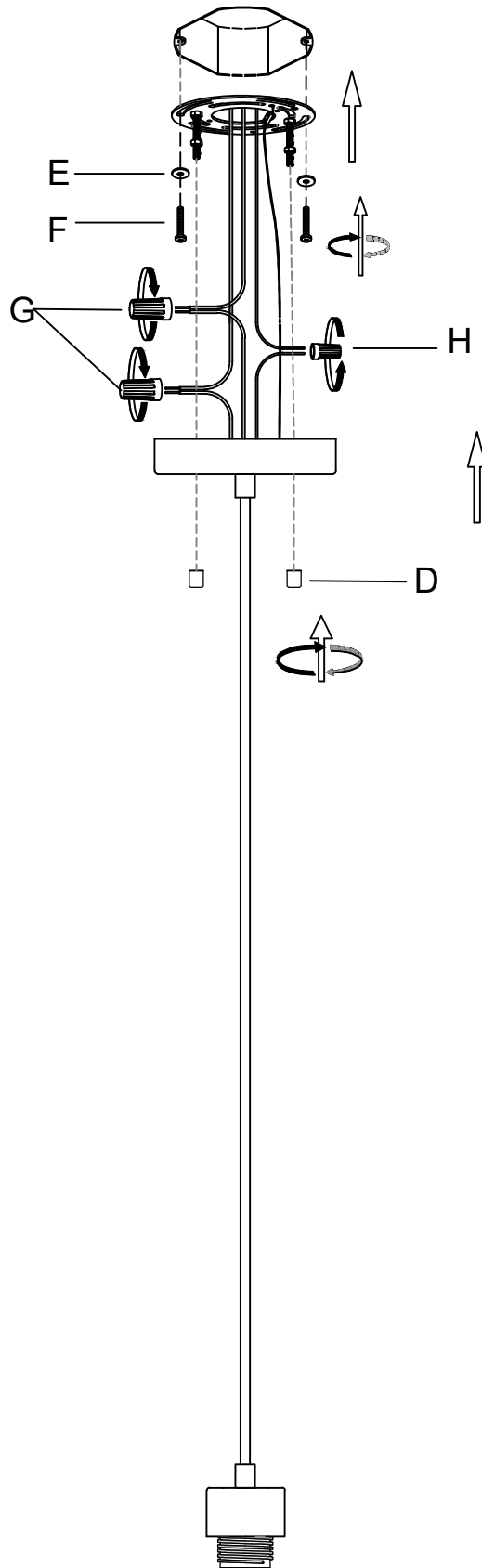

3

Put the Lamp Shade (B) together with Lamp (A) and use Lampholder Ring (C) to fix it.

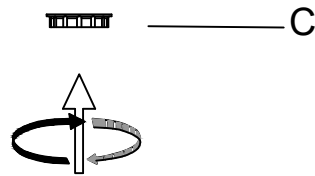
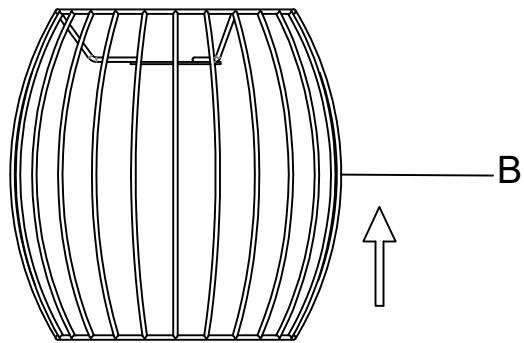
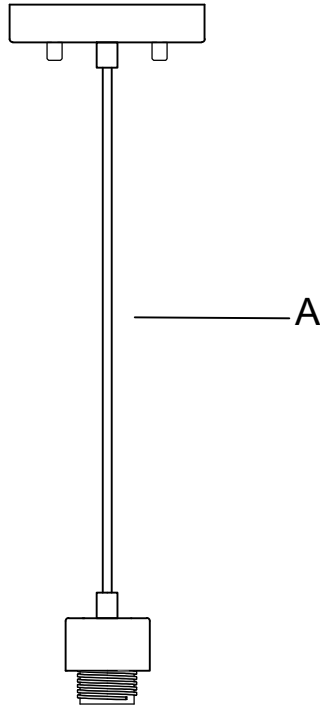

Cleaning & Care

Treat surface with care. Surface is resistant to scratches but is not scratch resistant. Clean surfaces with a dry or damp soft cloth. Do not use abrasive cleaners. Hardware may loosen over time. Periodically check that all connections are tight.