

2 Seat Sofa Linen

2 Seat Velvet Sofa

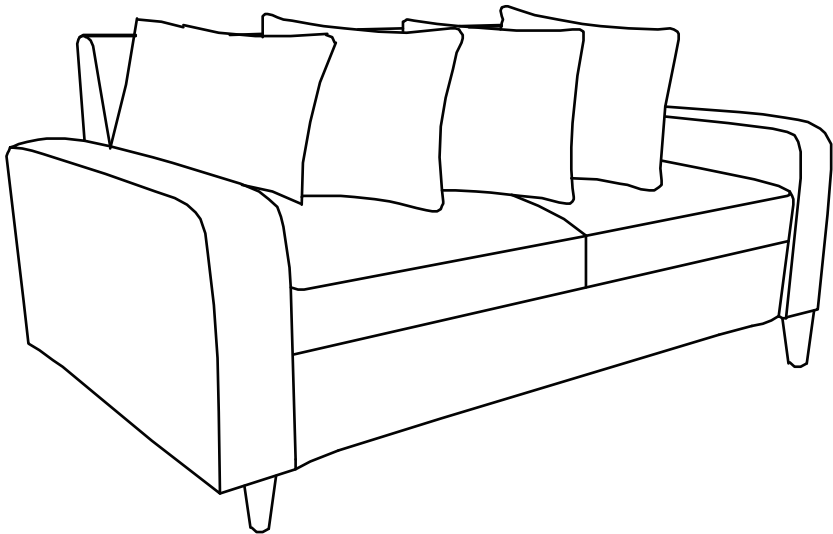

CONTENTS

Safety and care advice	1
Components – parts	2
Components – fittings	3
Assembly instructions	4
Copyright	9

⚠ SAFETY AND CARE ADVICE ⚠

PLEASE READ THESE INSTRUCTIONS CAREFULLY AND KEEP FOR FUTURE REFERENCE

- **Warning:** This unit weighs approximately 29.5kgs. Please lift with care.
- Check you have all the components and tools listed on pages 2 and 3.
- Remove all fittings from the plastic bags and separate them into their groups.
- Keep children and animals away from the work area, small parts could choke if swallowed.
- Make sure you have enough space to layout the parts before starting.
- Do not stand or put weight on the product, this could cause damage.
- Assemble the item as close to its final position (in the same room) as possible.

- Assemble on a soft level surface to avoid damaging the unit or your floor (use opened out unit carton).



- We do not recommend the use of power drill/drivers **for inserting screws**, as this could damage the unit. Only use hand screwdrivers.
- Dispose of all packaging carefully and responsibly.

CARE AND MAINTENANCE

- Only clean using a damp cloth and mild detergent, do not use bleach or abrasive cleaners.
- From time to time check that there are no loose screws on this unit.

- This product should not be discarded with household waste. Take to your local authority waste disposal center.

Note *If required the next page can be cut out and used as reference throughout the assembly. Keep this page with these instructions for future reference.*

COMPONENTS — PARTS

Please check you have all the parts listed below:

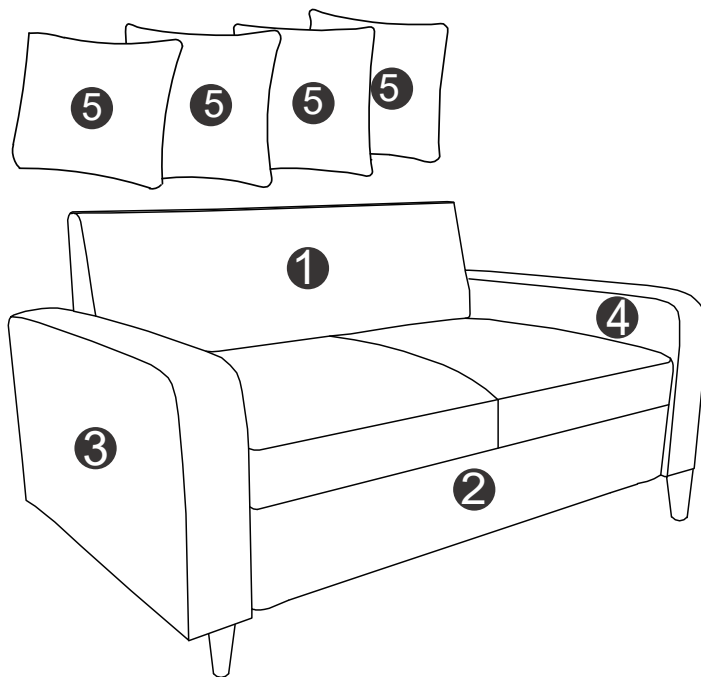

PARTS LIST

1 Sofa Backrest	x1	4 Left Armrest	x1
2 Sofa Seat	x1	5 Backrest Pillow	x4
3 Right Armrest	x1		



COMPONENTS — FITTINGS

Please check you have all the fittings listed below:

A  Bolt x 8

B  Washer x 8

C  Nut x 8

D  Wrench x 1

E  Foot x 4



ASSEMBLY INSTRUCTIONS

Step 1

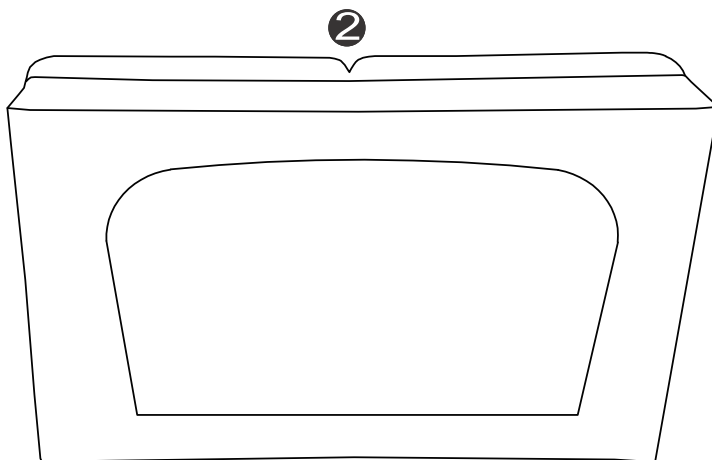

⚠ IMPORTANT:

Turn sofa upside down. Open the zipper which is under the sofa.

Inside you will find parts **3**, **4**, **5** x 4, **E** x 4 and all hardware.

Step 2

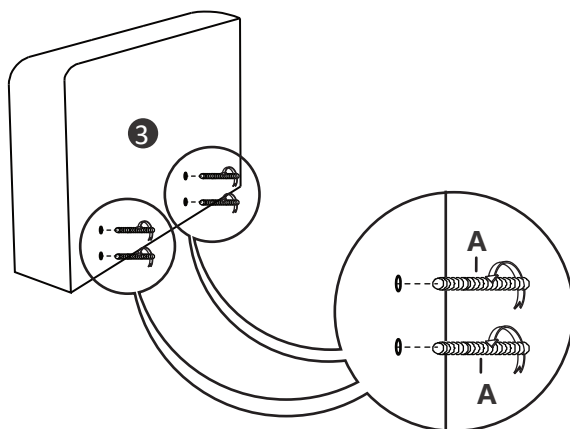
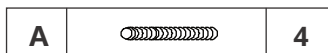

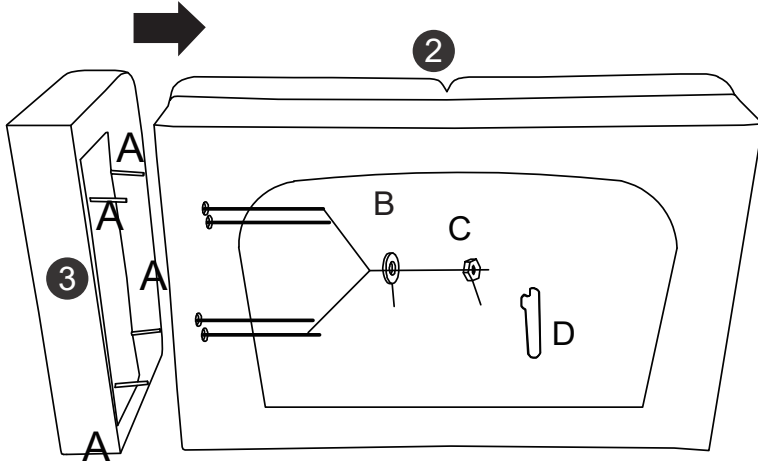

ASSEMBLY INSTRUCTIONS

Step 3



Step 4

B		4
C		4
D		1

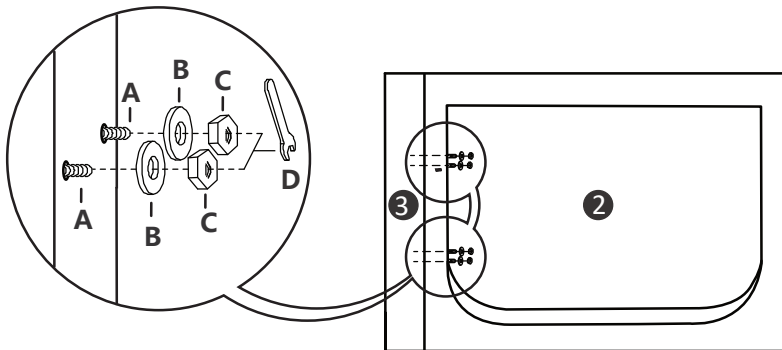



ASSEMBLY INSTRUCTIONS

Step 5

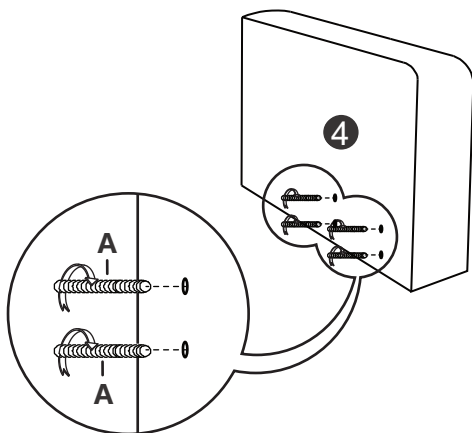
A		4
---	---	---



Step 6

B		4
C		4
D		1

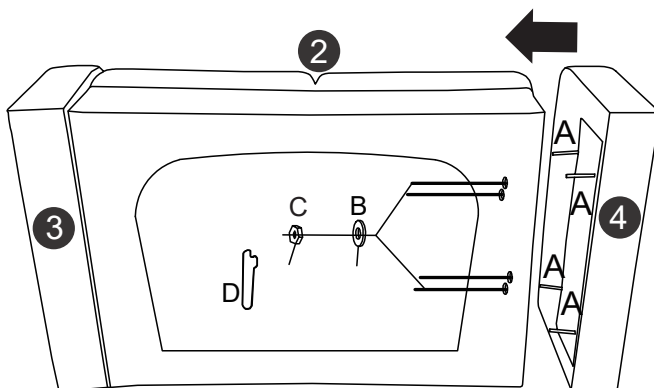

ASSEMBLY INSTRUCTIONS

Step 7

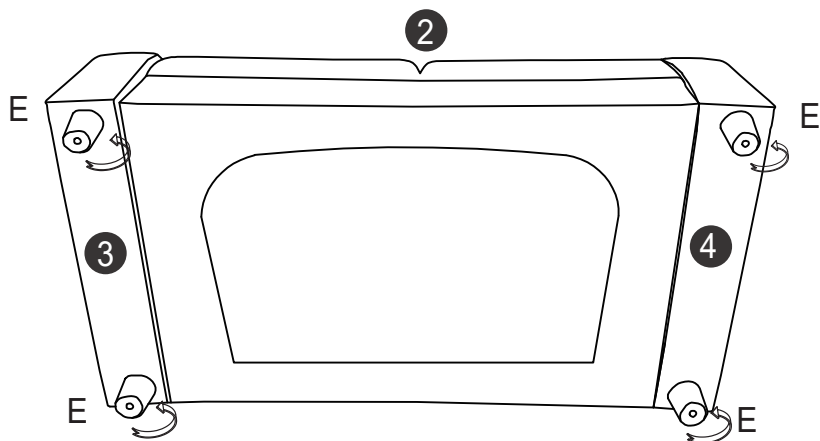

Step 8

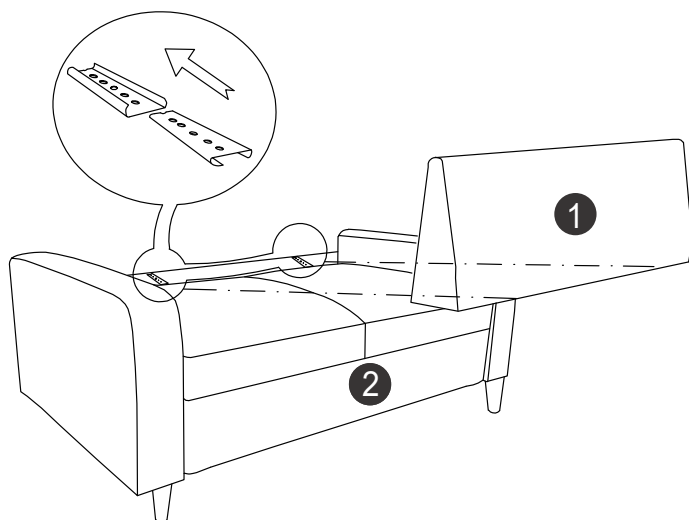

ASSEMBLY INSTRUCTIONS

Step 9

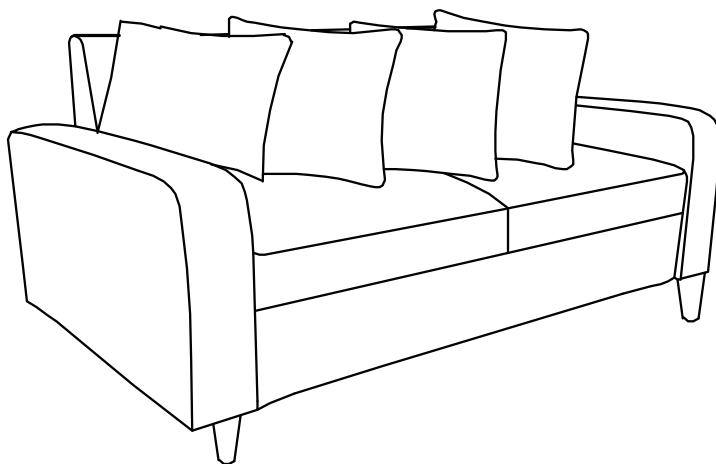
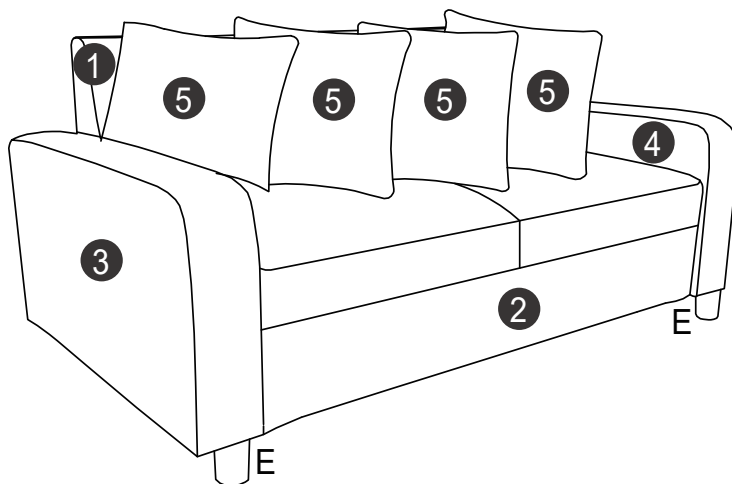

Congratulations! Now you have finished assembling the product.