

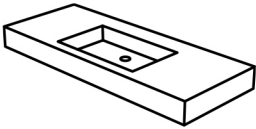

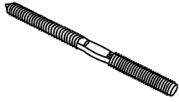





# PRODUCT ASSEMBLY INSTRUCTIONS

[ Product Model: FS140-1200 ]

## List :

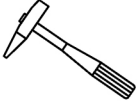
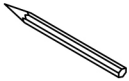
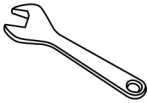
				
Solid Surface Bathroom Sink	Bolt x4	Nut x4	Metal Washer x4	Expansion sleeve x4

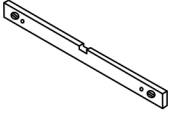
## Tools Required :

					
A	B	C	D	E	F

A	Hammer
B	Pencil
C	Wrench
D	Electrodrill
E	Gradienter
F	Steel tape

## Installation Steps : 1

Determine the mounting holes based on the holes in the back of the basin and mark the wall with a pencil (33"-36" is preferred for countertop height).

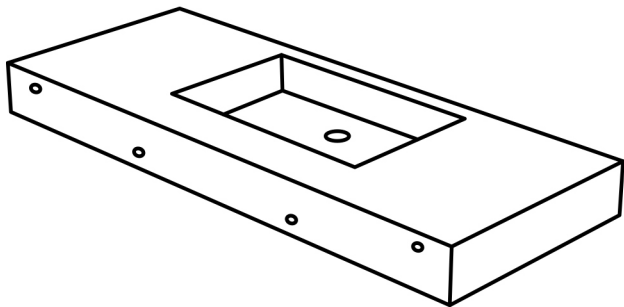

[ The back of the product ]

## Installation Steps : 2

Drill the hole at the mark with electric drill.

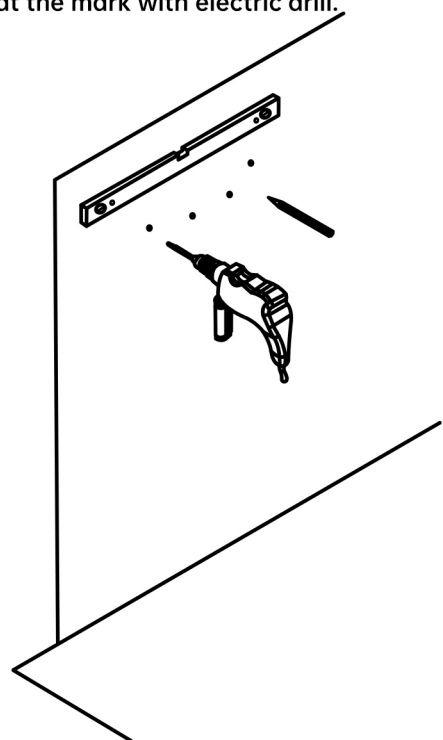

## Installation Steps : 3

Knock the white rubber plug of wall-hung accessories into pre-drilling hole with hammer.

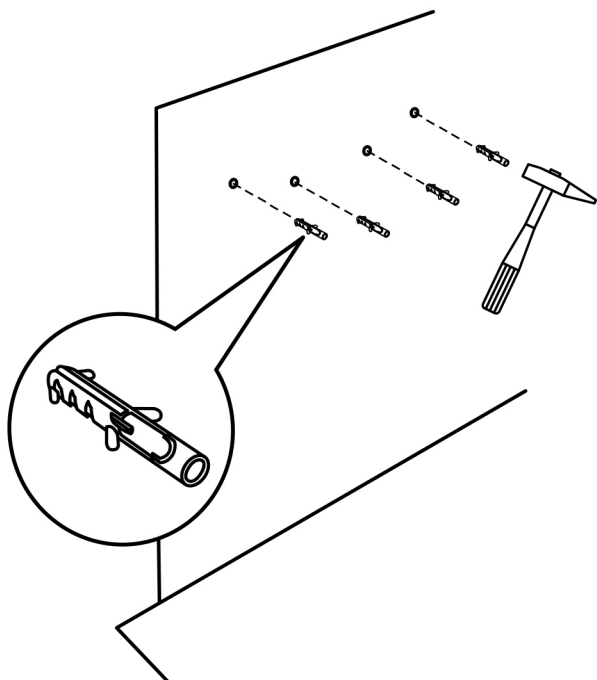

## Installation Steps : 4

Hold the basin and use a spanner to lock the basin to the wall.

