

## **IF YOU FIND A DEFECTIVE PART**

---

We fully stock all parts and components. Any defective part can be quickly replaced. Take note of the defective part number in manual and we will arrange a quick replacement.

You can email our team

## **COPYRIGHT**

---

All material in this instruction manual is copyrighted

Any unauthorised use may violate worldwide copyright, trademark and other laws.

## **Instruction manual Tracy 3 Seat Sofa**

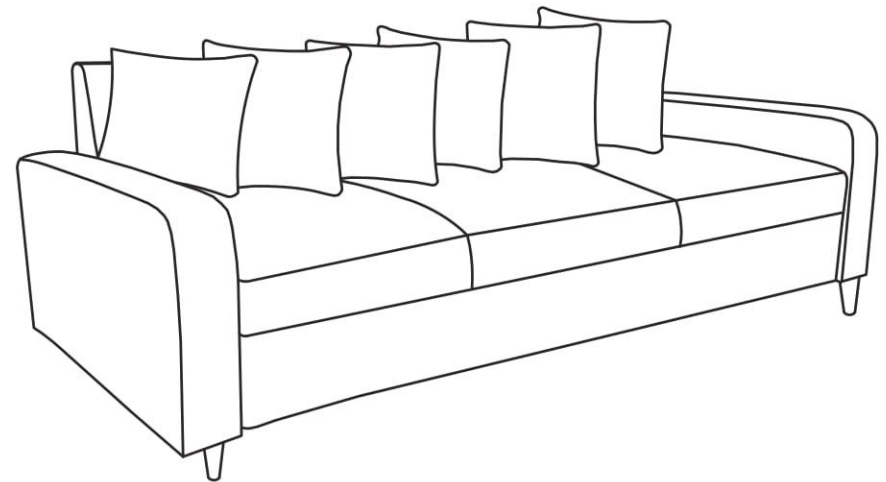

Thank you for purchasing!

# ASSEMBLY INSTRUCTIONS

---

## Step 9

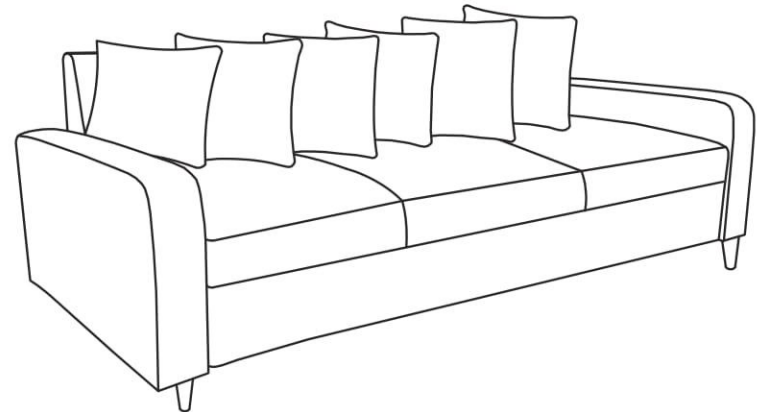
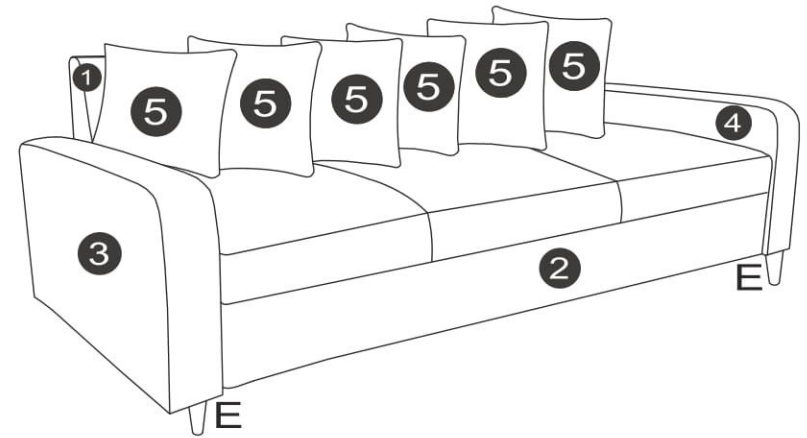

Congratulations! Now you have finished assembling the product.

# ASSEMBLY INSTRUCTIONS

---

## Step 7

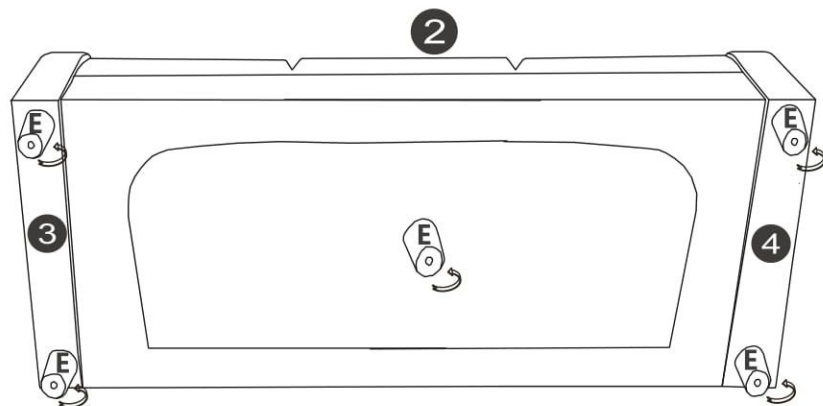

---

## Step 8

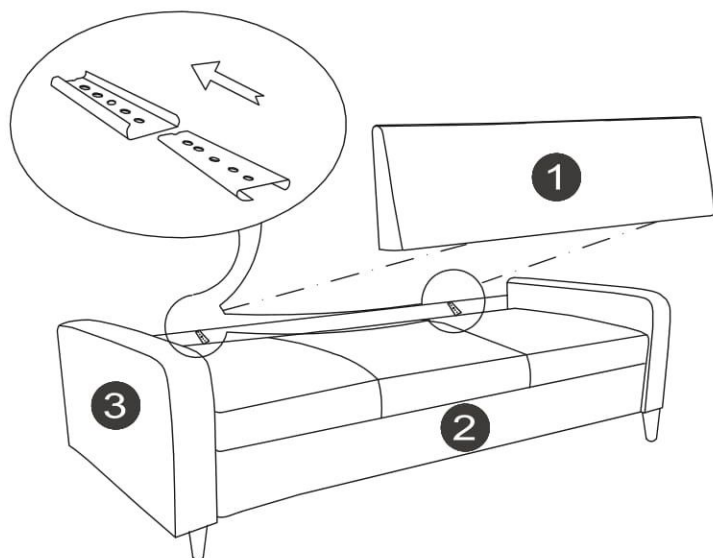

---

## CONTENTS

---

Safety and care advice	1
Components	2
Assembly instructions	4
Copyright	9

## ⚠ SAFETY AND CARE ADVICE ⚠

PLEASE READ THESE INSTRUCTIONS CAREFULLY AND KEEP FOR FUTURE REFERENCE

- **Warning:** Please lift with care.
- Check you have all the components and tools listed on pages 2 and 3.
- Remove all fittings from the plastic bags and separate them into their groups.
- Keep children and animals away from the work area, small parts could choke if swallowed.
- Make sure you have enough space to lay out the parts before starting.
- Do not stand or put weight on the product, this could cause damage.
- Assemble the item as close to its final position (in the same room) as possible.

- Assemble on a soft level surface to avoid damaging the unit or your floor (use opened out unit carton).



- We do not recommend the use of power drill/drivers **for inserting screws**, as this could damage the unit. Only use hand screwdrivers.
- Dispose of all packaging carefully and responsibly.

## CARE AND MAINTENANCE

- Only clean using a damp cloth and mild detergent, do not use bleach or abrasive cleaners.
- From time to time check that there are no loose screws on this unit.

- This product should not be discarded with household waste. Take to your local authority waste disposal center.

**Note** If required the next page can be cut out and used as reference throughout the assembly. Keep this page with these instructions for future reference.



## ASSEMBLY INSTRUCTIONS

### Step 5

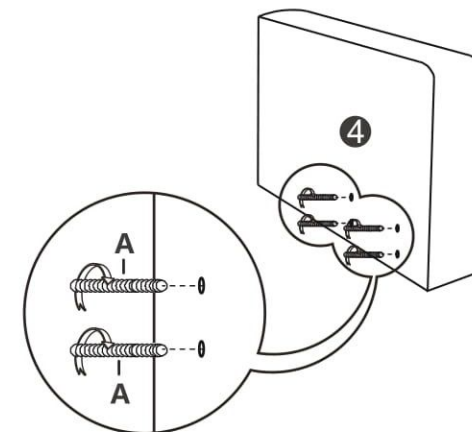
A		4
---	---	---



### Step 6

B		4
C		4
D		1

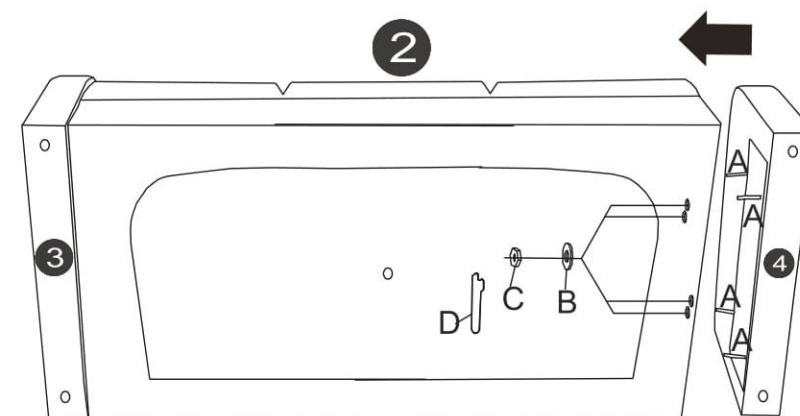

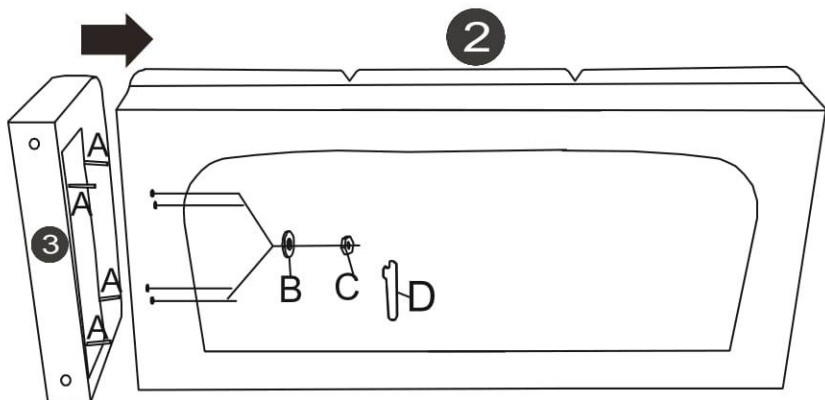

# ASSEMBLY INSTRUCTIONS

## Step 3



## Step 4

B		4
C		4
D		1

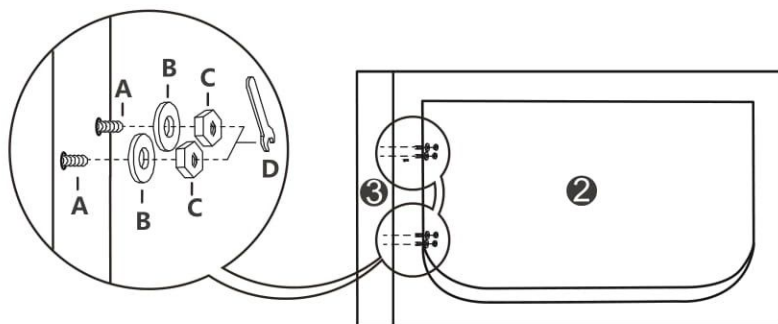

# COMPONENTS — PARTS

Please check you have all the parts listed below:

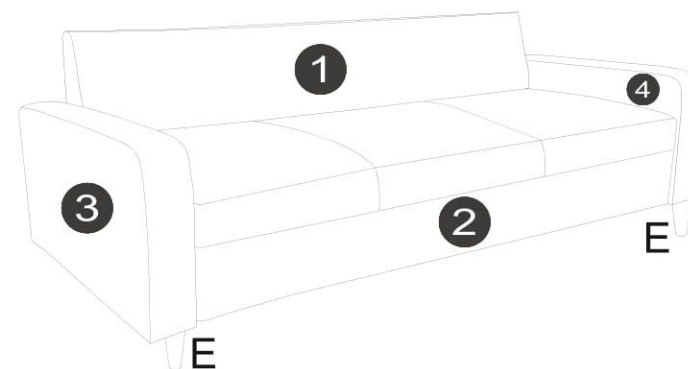

## PARTS LIST

1	Sofa Backrest	x1	4	Left Armrest	x1
2	Sofa Seat	x1	5	Backrest Pillow	x6
3	Right Armrest	x1			



# COMPONENTS — FITTINGS

Please check you have all the fittings listed below:

**A**  Bolt x 8

**B**  Washer x 8

**C**  Nut x 8

**D**  Wrench x 1

**E**  Foot x 5

# ASSEMBLY INSTRUCTIONS

Step 1

**2**

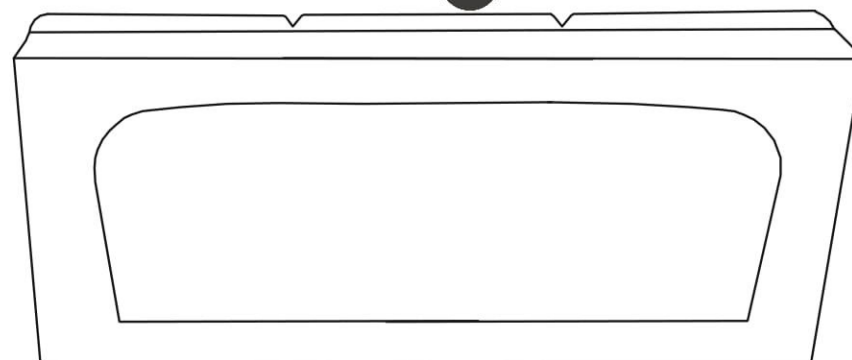

**⚠ IMPORTANT:**  
Turn sofa upside down. Open the zipper which is under the sofa.  
Inside you will find parts **3**, **4**, **5** x 6, **E** x 5 and all hardware.

Step 2

