

# ASSEMBLY INSTRUCTIONS & PARTS IDENTIFICATION COUNTER HEIGHT BENCH

Thank you for purchasing this quality product. Be sure to check all packing material carefully for small parts that may have come loose inside the carton during shipment.

| Hardware kit |        |                    |
|--------------|--------|--------------------|
| No           | Q'Ty   | Description        |
| A            | 12 pcs | Lock Washer 5/16"  |
| B            | 12 pcs | Flat Washer 5/16"  |
| C            | 12 pcs | Bolt 1/4" x 1 3/4" |
| D            | 1 pc   | Allen Key          |
| E            | 14 pcs | Screw Ø4 x 38mm    |

| Key Parts |      |       |                        |  |
|-----------|------|-------|------------------------|--|
| No        | Code | Q'Ty  | Description            |  |
| 1         | A    | 6 pcs | Floor glide            |  |
| 2         | B    | 1 pc  | Bench Seat             |  |
| 3         | C    | 2 pcs | Right Facing Front Leg |  |
| 4         | D    | 2 pcs | Left Facing Front Leg  |  |
| 5         | E    | 2 pcs | Middle Leg             |  |
| 6         | F    | 4 pcs | Long Bench Stretcher   |  |
| 7         | G    | 3 pcs | Short Bench Stretcher  |  |

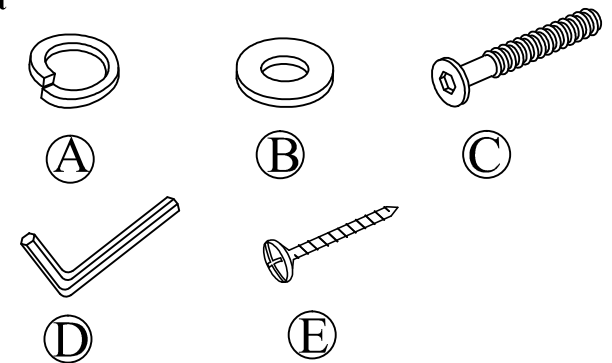

Remove bottom seat material before setup

## STEP 1

- Carefully lay Bench seat up side down on a smooth flat surface to prevent scratches.
- Affix a leg (3), to each corner of the bench seat as shown in Detail ( A) using a flat washer, lock washer , bolt.Do not fully tighten the Bolts at this point.
- Affix a middle leg (4) to the bench seat as shown in Detail (B) using a flat washer , lock washer and Bolt. Do not fully tighten the Bolts at this point.
- Insert 4 long stertcher then insert 3 short stretcher between side leg and middle leg, faster stretchers with screw using Screwdriver (not provide). (Detail C).
- After all the stretchers are in place, tighten all Bolts.
- Replace bottom seat material.

DETAIL A

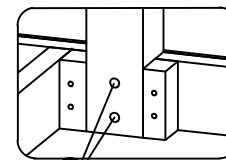
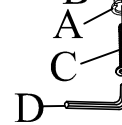
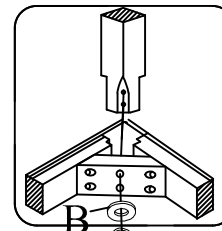

DETAIL B

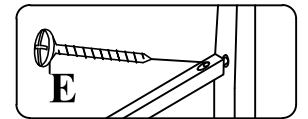
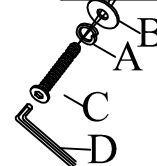

DETAIL C

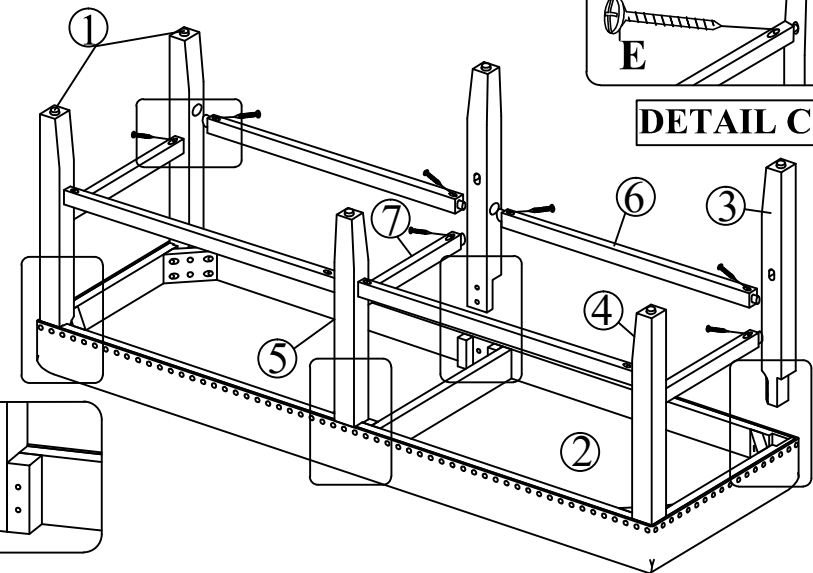

### FABRIC CARE INSTRUCTION REGULAR CARE

Clean with shampoo, foam, or dry cleaning solvents as desired.  
Do not saturate with liquid. Pile fabrics may require brushing to restore appearance.  
Cushion covers should not be removed and dry cleaned.  
FABRIC CONTENT: 100% Polyester; Cleaning code "WS"