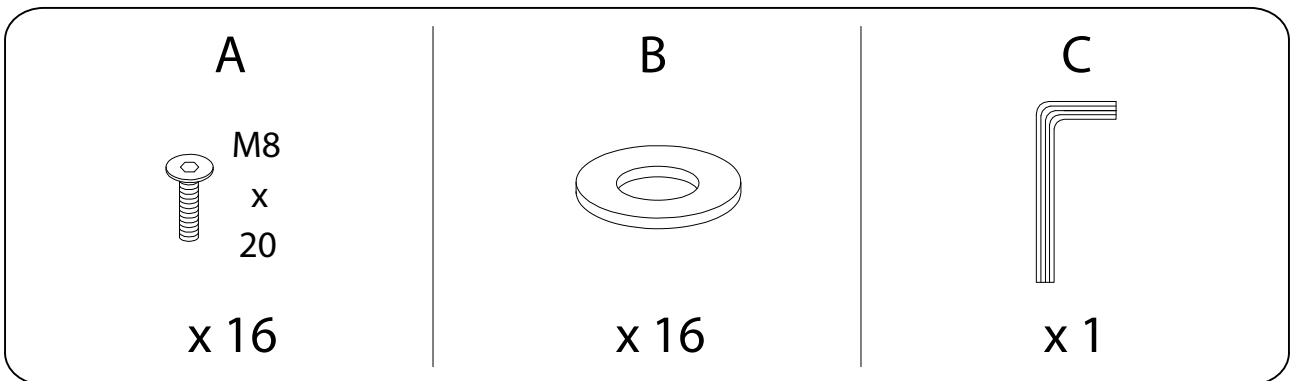
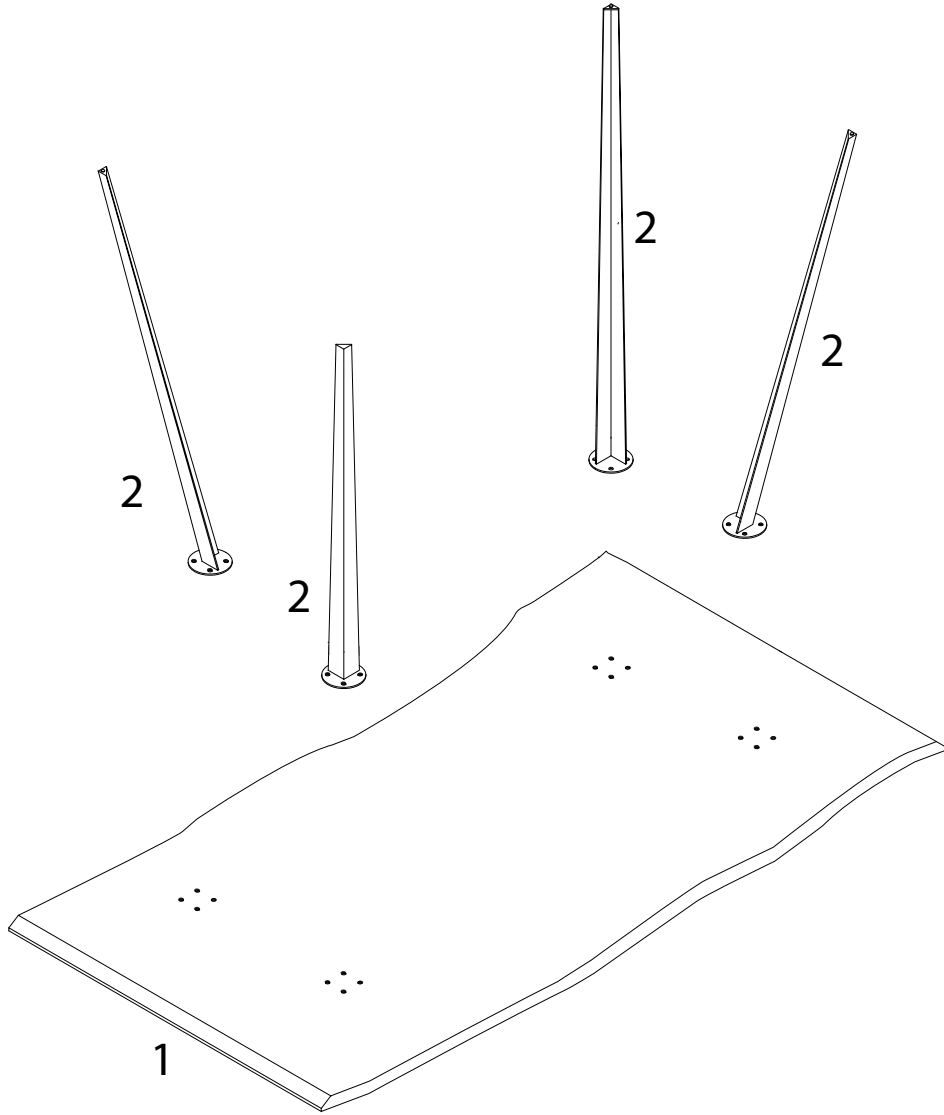
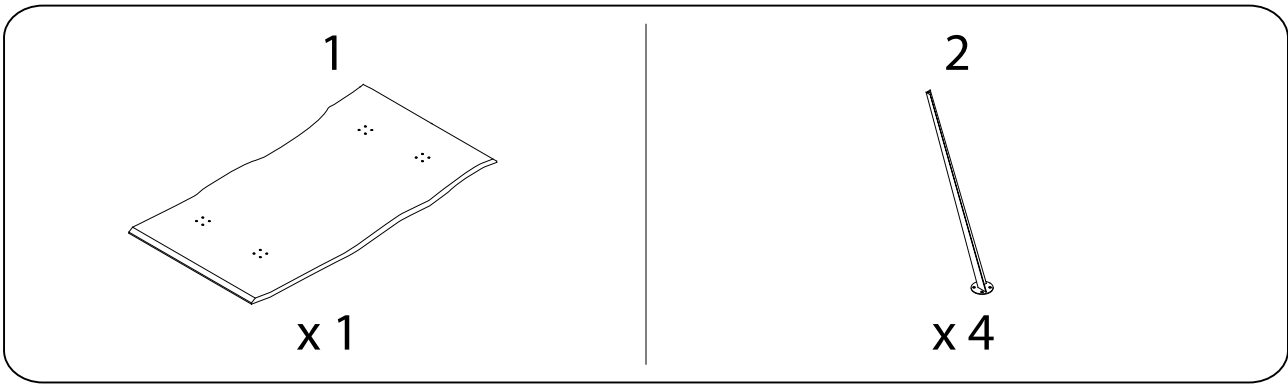
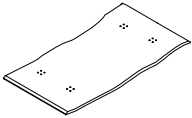





Diagram illustrating assembly steps and safety warnings:

- Step 1:** Shows an L-shaped metal bracket being inserted into a hole in the table top. A power drill is shown with a slash through it, indicating it should not be used. A warning triangle with an exclamation mark is positioned to the right.
- Step 2:** Shows a rectangular block being placed on a surface. A warning triangle with an exclamation mark is positioned to the right.
- Time:** A clock icon is shown, indicating a time of 20 minutes.
- Personnel:** A person icon is shown, indicating that 2 people are required for assembly.



1

| | | | | |
|---|---|---|--|---|
| <p>1</p>  <p>x 1</p> | <p>2</p>  <p>x 4</p> | <p>A</p>  <p>M8 x 20</p> <p>x 16</p> | <p>B</p>  <p>x 16</p> | <p>C</p>  <p>x 1</p> |
|---|---|---|--|---|

