

**EN - 2 boxes in total, This is 1/2 box.**

**DE - Insgesamt 2 Pakete, Das ist 1/2 Paket.**

**ES - 2 cajas en total, Esto es 1/2 caja.**

**FR - 2 boîtes au total, Il s'agit de 1/2 box.**

**IT - 2 scatole in totale, Questa è una scatola da 1/2.**

## CAUTION

EN

- Keep away from fire or other heat sources.
- We recommend wearing protective gloves.
- Firmly secure all bolts, screws, and knobs before use.
- Every 90 days, check that all nuts, screws, and knobs are securely fastened.
- If any parts are missing, broken, damaged, or worn, stop using this item until repairs are made and/or factory replacement parts are installed.
- Please follow the instruction manuals and use a pad to avoid damage during assembly.

## ACHTUNG

DE

- Halten Sie es von Feuer oder anderen Wärmequellen fern.
- Es wird empfohlen, Schutzhandschuhe zu tragen.
- Ziehen Sie alle Bolzen, Schrauben und Knöpfe vor dem Gebrauch fest an.
- Prüfen Sie regelmäßig alle 90 Tage, ob alle Muttern, Schrauben und Knöpfe fest angezogen sind.
- Sollten Teile fehlen, gebrochen, beschädigt oder abgenutzt sein, verwenden Sie das Gerät nicht mehr, bis es repariert und/oder durch Originalersatzteile ersetzt wird.
- Bitte folgen Sie den Anweisungen in der Anleitung und verwenden Sie eine Unterlage, um Schäden bei der Montage zu vermeiden.

## PRECAUCION

ES

- Mantener alejado del fuego u otras fuentes de calor.
- Recomendamos usar guantes protectores.
- Asegure firmemente todos los pernos, tornillos y perillas antes de usar.
- Cada 90 días, compruebe que todas las tuercas, tornillos y pomos estén bien apretados.
- Si falta alguna pieza, está rota, dañada o desgastada, deje de utilizar este artículo hasta que se realicen las reparaciones y/o se instalen las piezas de repuesto de fábrica.
- Por favor, siga los manuales de instrucciones y utilice una almohadilla para evitar daños durante el montaje.

## ATTENTION

FR

- Éloignez l'appareil de toute source de chaleur ou de flammes.
- Il est recommandé de porter des gants de protection.
- Assurez-vous de bien serrer tous les boulons, vis et boutons avant d'utiliser l'appareil.
- Tous les 90 jours, assurez-vous que tous les écrous, vis et boutons sont correctement serrés.
- Si vous constatez des pièces manquantes, cassées, endommagées ou usées, cessez d'utiliser l'appareil jusqu'à ce qu'il soit réparé et/ou que des pièces de rechange d'origine soient installées.
- Veuillez suivre les instructions du manuel et utilisez un coussin de protection pour éviter d'endommager l'appareil pendant l'assemblage.

## ATTENZIONE

IT

- Tenere lontano dal fuoco o da altre fonti di calore.
- Si consiglia di indossare guanti protettivi.
- Prima dell'uso, fissare saldamente tutti i bulloni, le viti e le manopole.
- Ogni 90 giorni, controllare che tutti i dadi, i bulloni e le manopole siano saldamente fissati.
- Se si riscontrano parti mancanti, rotte, danneggiate o usurate, interrompere l'uso dell'apparecchio fino a quando non saranno effettuate le riparazioni e/o montate le parti di ricambio originali.
- Seguire le istruzioni per l'uso e utilizzare un cuscinetto per evitare danni durante il montaggio.

EN



1 PERSON ASSEMBLY

60

MIN ASSEMBLY

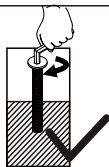

HALF TIGHTEN THE  
SCREW

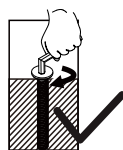

TIGHTEN ALL SCREWS  
COMPLETELY

DE



1 PERSON MONTAGE

60

MIN. MONTAGE

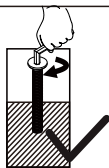

SCHRAUBE HALB  
ANZIEHEN

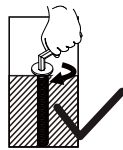

ALLE SCHRAUBEN  
VOLLSTÄNDIG  
FESTZIEHEN

ES



MONTAJE POR 1  
PERSONA

60

MONTAJE MIN

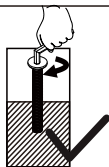

APIRIETE EL TORNILLO  
HASTA LA MITAD

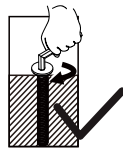

APIRIETE  
COMPLETAMENTE  
TODOS LOS TORNILLOS

FR



ASSEMBLAGE PAR 1  
PERSONNE

60

MINUTES  
D'ASSEMBLAGE

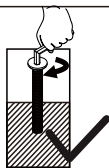

SERRER LA MOITIÉ  
DE LA VIS

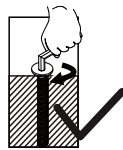

SERREZ  
COMPLÈTEMENT LA VIS

IT



MONTAGGIO PER 1  
PERSONA

60

MONTAGGIO  
MINIMO

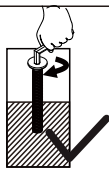



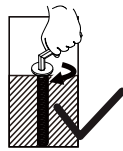



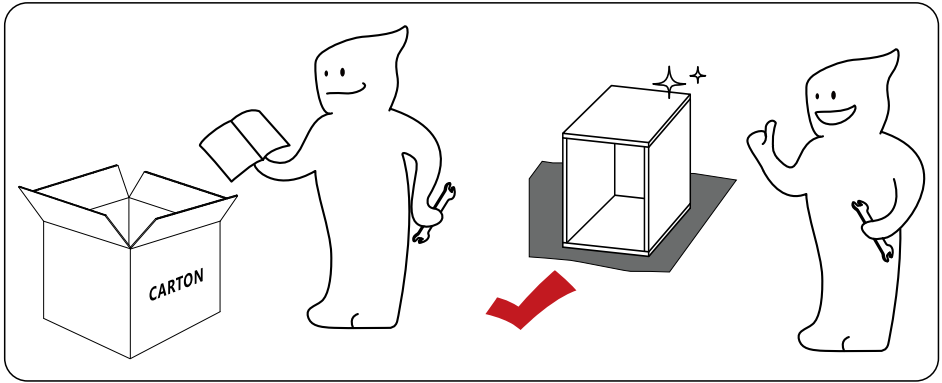
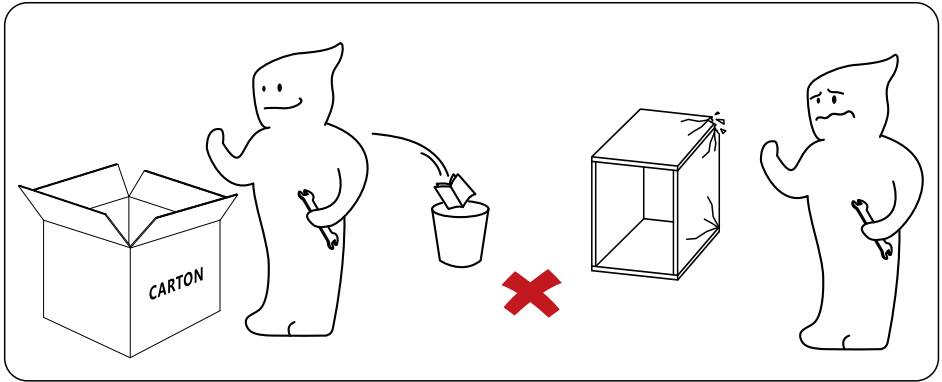



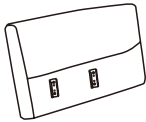
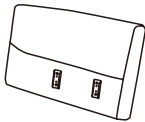
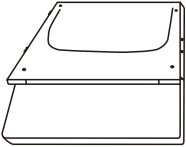
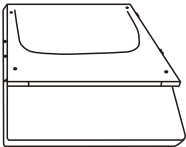
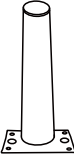

SERRARE A METÀ  
LA VITE













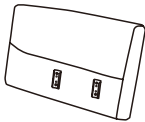
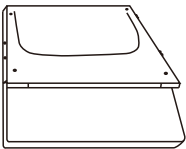
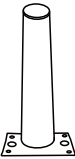

SERRARE  
COMPLETAMENTE  
TUTTE LE VITI



# Total Parts List

<p>① × 1 L</p> 	<p>② × 1 R</p> 	<p>③ × 1 L</p> 	
<p>④ × 1 R</p> 	<p>⑤ × 2</p> 	<p>⑥ × 4</p> 	
<p>Ⓐ × 4</p> 	<p>Ⓑ × 4</p> 	<p>Ⓒ × 2</p> 	<p>Ⓓ × 4</p> 
<p>Ⓔ × 4</p> 	<p>Ⓕ × 1</p> 	<p>Ⓖ × 8</p> 	<p>Ⓗ × 2</p> 
<p>Ⓛ × 2</p> 	<p>Ⓜ × 8</p> 	<p>Ⓚ × 4</p> 	

# Parts List of Box 1/2

<p>② × 1 R</p> 	<p>④ × 1 R</p> 	<p>⑤ × 1</p> 	
<p>⑥ × 2</p> 	<p>Ⓐ × 4</p> 	<p>Ⓑ × 4</p> 	
<p>Ⓒ × 2</p> 	<p>Ⓓ × 4</p> 	<p>Ⓔ × 4</p> 	<p>Ⓕ × 1</p> 
<p>Ⓖ × 8</p> 	<p>Ⓗ × 2</p> 	<p>Ⓘ × 2</p> 	<p>⓵ × 8</p> 
<p>Ⓚ × 4</p> 			

# Parts List of Box 1/2

② X 1 R

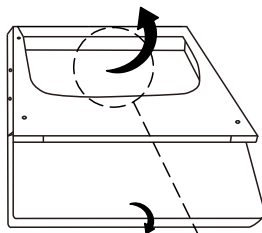

④ X 1 R

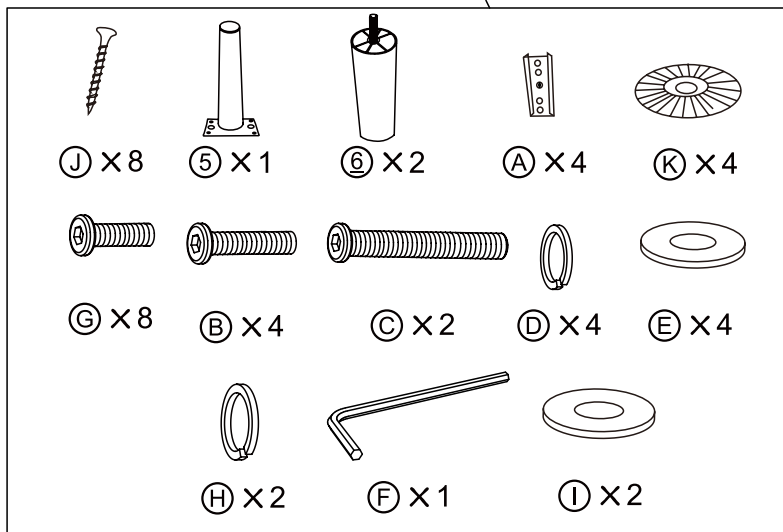

**EN** - Remove all parts from the storage compartment located at the back of the sofa backrest or bottom of the seat prior to assembly.



**DE** - Vor dem Aufbau nehmen Sie alle Zubehörteile aus dem Staufach, das sich an der Rückseite der Rückenlehne oder an der Unterseite des Sitzes befindet.

**ES** - Retire todas las piezas del compartimiento de almacenamiento ubicado en la parte posterior del respaldo del sofá o en la parte inferior del asiento antes del ensamblaje.

**FR** - Avant l'installation du produit, veuillez retirer le kit d'accessoires des compartiments derrière le dossier ou en bas d'assise.

**IT** - Si prega di rimuovere tutte le parti dal vano portaoggetti situato sul retro dello schienale del divano o sul fondo della seduta prima del montaggio .

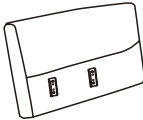
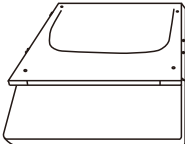
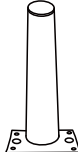
# Parts List of Box 2/2

<p>① x 1 L</p> 	<p>③ x 1 L</p> 	<p>⑤ x 1</p> 
<p>⑥ x 2</p> 		

# Parts List of Box 2/2

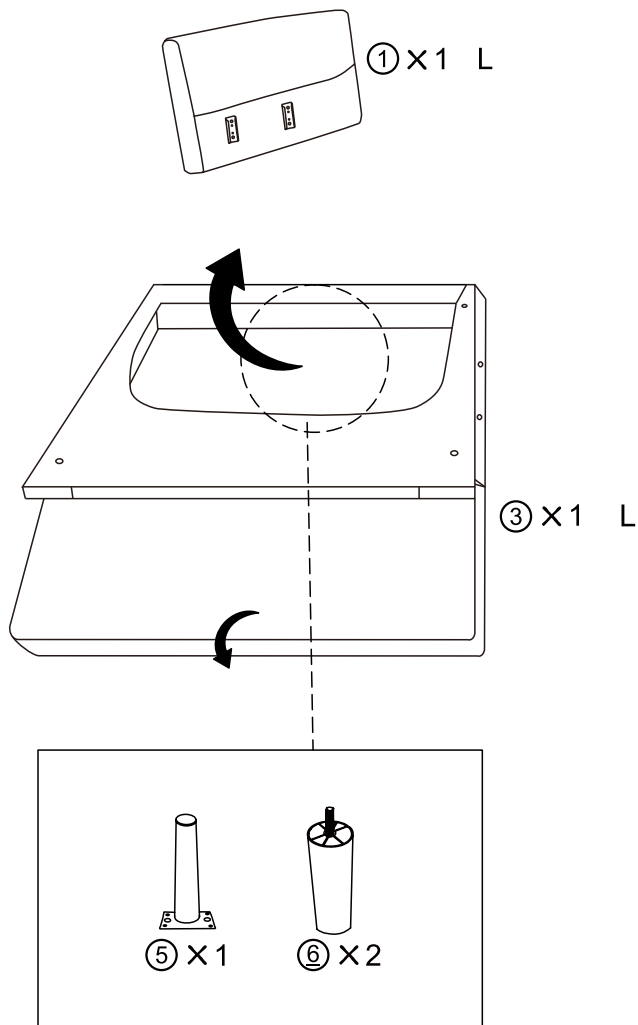

**EN** - Remove all parts from the storage compartment located at the back of the sofa backrest or bottom of the seat prior to assembly.





**DE** - Vor dem Aufbau nehmen Sie alle Zubehörteile aus dem Staufach, das sich an der Rückseite der Rückenlehne oder an der Unterseite des Sitzes befindet.

**ES** - Retire todas las piezas del compartimiento de almacenamiento ubicado en la parte posterior del respaldo del sofá o en la parte inferior del asiento antes del ensamblaje.

**FR** - Avant l'installation du produit, veuillez retirer le kit d'accessoires des compartiments derrière le dossier ou en bas d'assise.

**IT** - Si prega di rimuovere tutte le parti dal vano portaoggetti situato sul retro dello schienale del divano o sul fondo della seduta prima del montaggio .





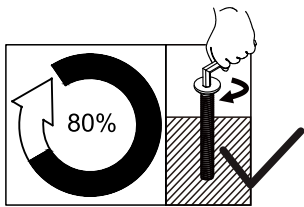
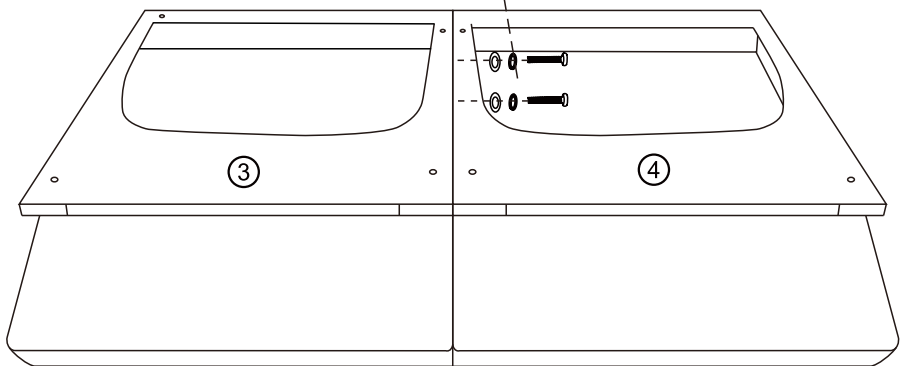
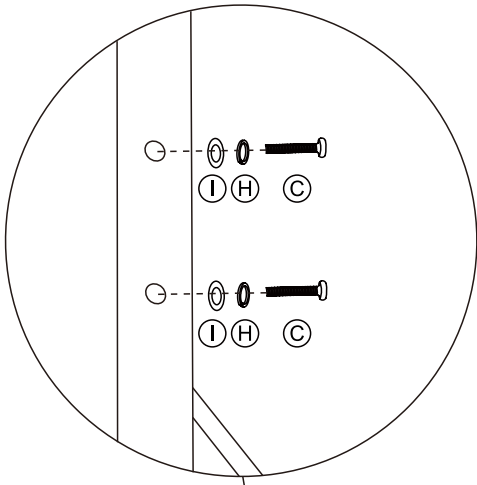

# 1

③		x1
④		x1
Ⓒ		x2
Ⓗ		x2
Ⓘ		x2





**EN** - Screw C to the holes. Please do not tighten them fully.  
**DE** - Die Schrauben C beim Einsetzen noch nicht fest anziehen.  
**ES** - Pieza C: Atornille a los agujeros. No los apriete del todo.  
**FR** - Insérez les vis C dans les trous. Ne les serrez pas à fond.  
**IT** - Avvitare C nei fori. Si prega di non stringere completamente le viti.

2

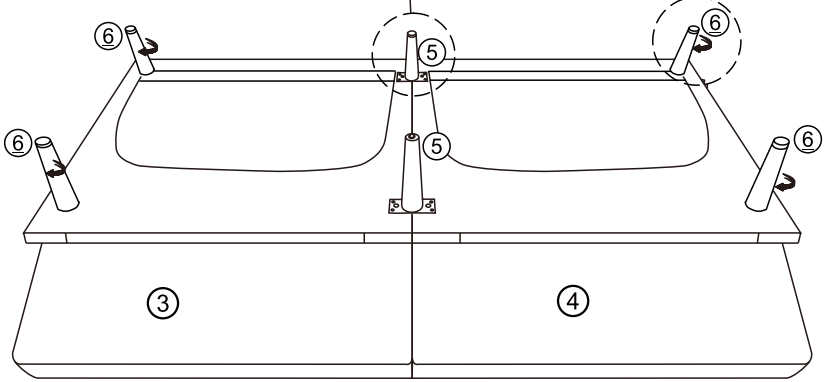
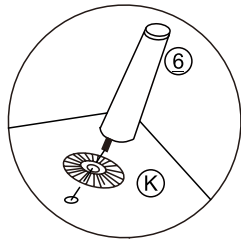
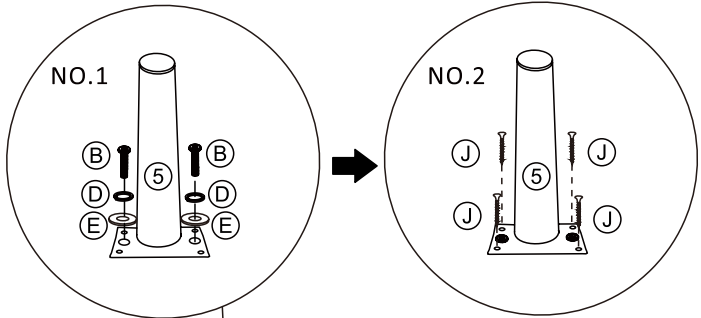
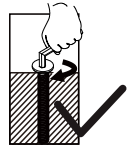
⑤		x2
⑥		x4
Ⓑ		x4
Ⓓ		x4
Ⓔ		x4
Ⓙ		x8
Ⓚ		x4



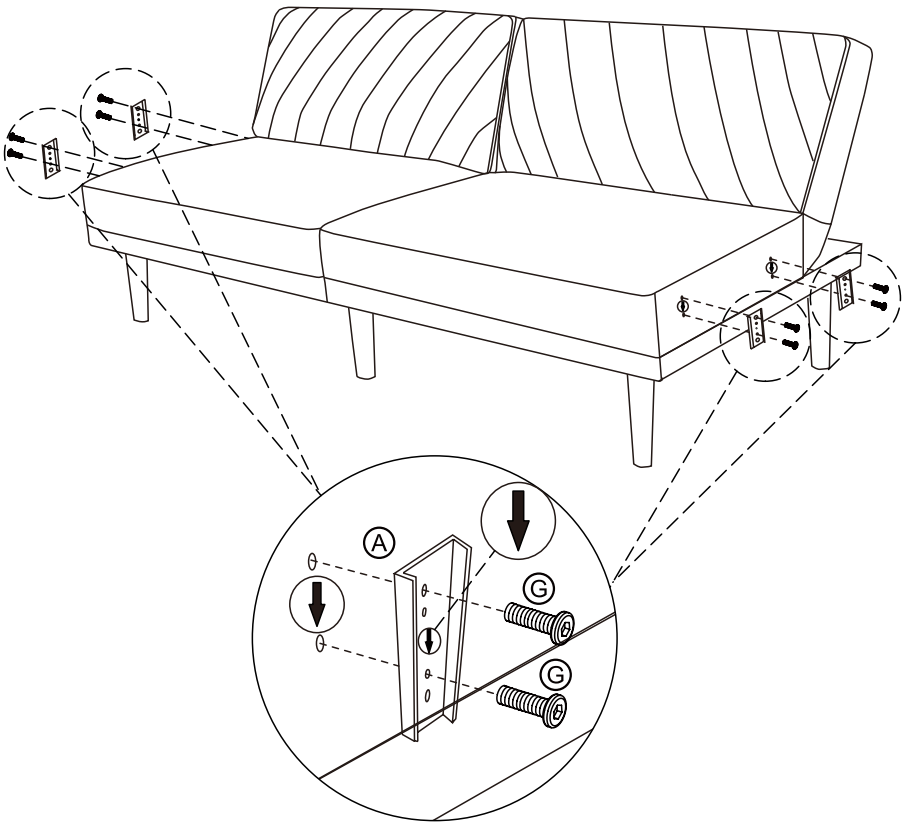
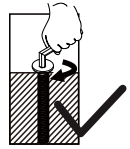

3

(A)	 x4
(G)	 x8



4

①	 x1
②	 x1

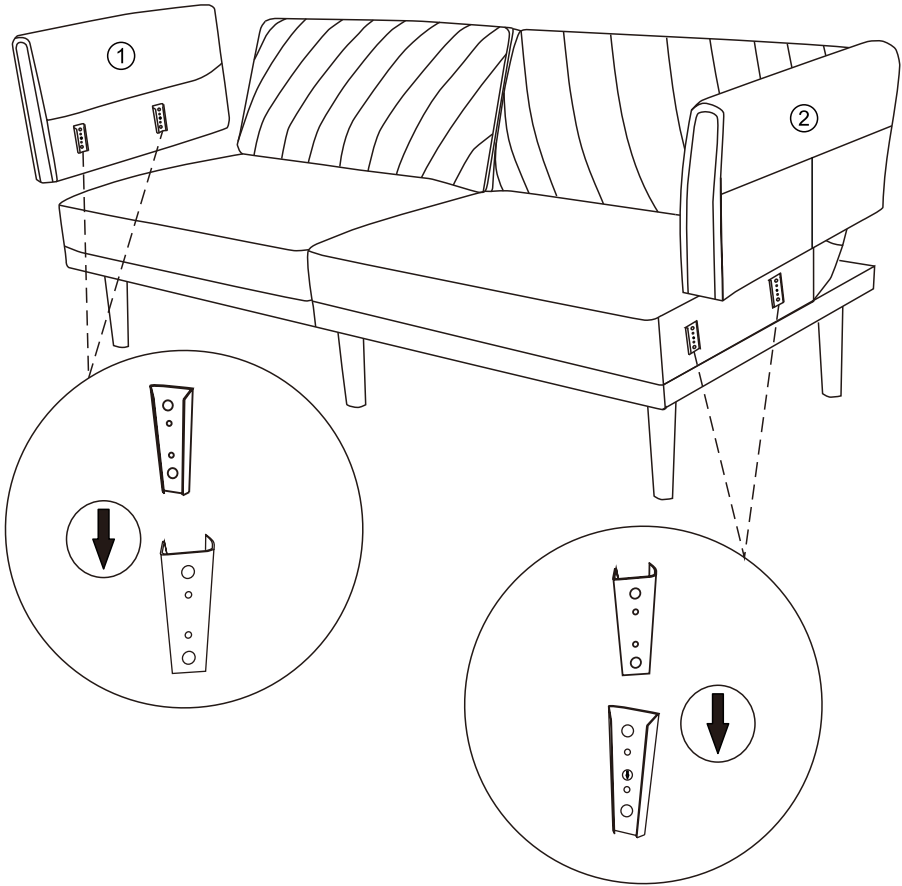

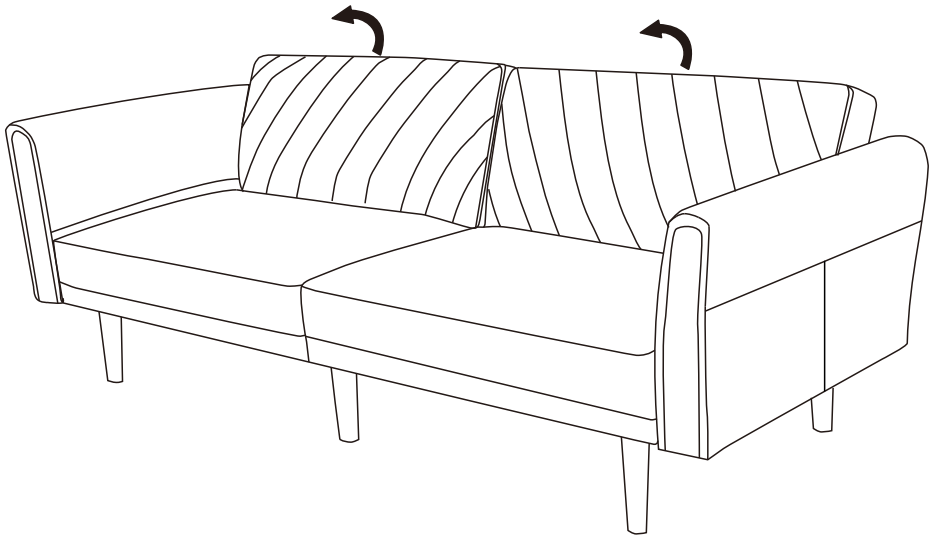

5

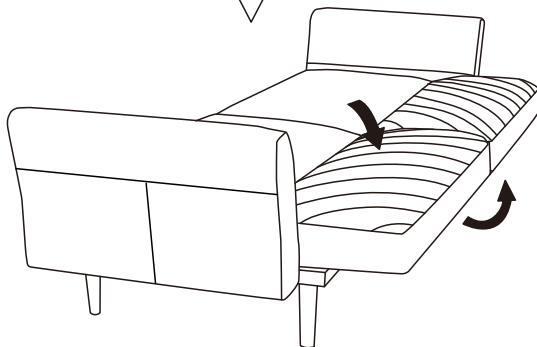
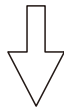
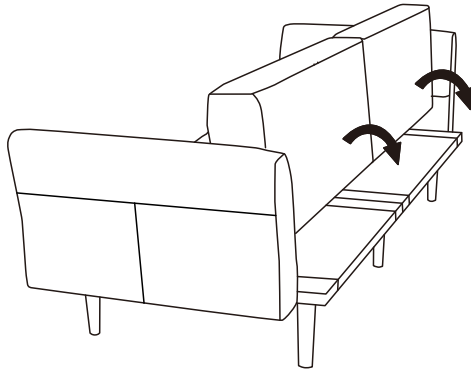
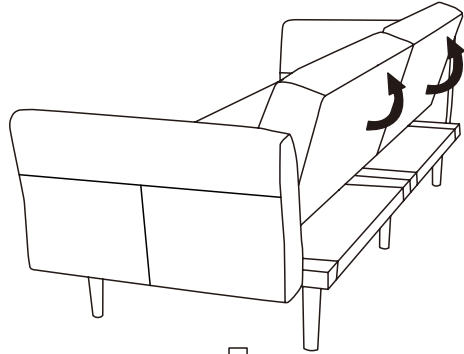

- EN** - Raise the back of the sofa.  
**DE** - Heben Sie die Rückenlehne des Sofas an.  
**ES** - Levantar el respaldo del sofá.  
**FR** - Relevez le dos du sofa.  
**IT** - Sollevare il retro del sofà.

6



	<p><b>EN - Velvet</b>          Vacuum your piece monthly to keep the velvet looking like new.          Use a nylon brush to remove any dirt or food.          Contact a professional annually for a deep clean.</p> <p><b>DE - Samt</b>          Reinigen Sie den Samtbezug regelmäßig mit dem Staubsauger.          Um größeren Schmutz zu entfernen, verwenden Sie bitte eine weiche Nylonbürste.          Für eine Intensivreinigung empfehlen wir, einen professionellen Reinigungsdienst zu beauftragen.</p> <p><b>ES - Piel</b>          Aspire la pieza mensualmente para mantenerla como nueva.          Utilice un cepillo de nylon para eliminar cualquier suciedad o comida.          Póngase en contacto con un profesional anualmente para una limpieza profunda.</p> <p><b>FR - Velours</b>          Passez l'aspirateur sur le velours une fois par mois pour qu'il conserve l'aspect du neuf.          Utilisez une brosse à textiles pour retirer la poussière ou les restes alimentaires.          Faites effectuer une fois par an un nettoyage professionnel.</p> <p><b>IT - Velluto</b>          Passa l'aspirapolvere ogni mese per mantenere il velluto come nuovo.          Usa una spazzola in nylon per rimuovere lo sporco.          Rivolgiti alle agenzie di pulizia professionali per una pulizia profonda una volta l'anno.</p>
	<p><b>EN - Stubborn Stains</b>          Blot stains with a damp cloth and a dash of dish soap.          Wipe away excess water with a clean towel.          Let the material air-dry fully before use.</p> <p><b>DE - Hartnäckige Flecken</b>          Entfernen Sie Flecken vorsichtig mit einem feuchten Tuch und wenig Spülmittel.          Überschüssiges Wasser zügig mit einem sauberen Handtuch abwischen.          Und nach der Reinigung das Material gut trocknen lassen.</p> <p><b>ES - Manchas persistentes</b>          Remueva las manchas con un paño húmedo y una pizca de jabón para platos.          Limpie el exceso de agua con una toalla limpia.          Deje que el material se seque completamente al aire libre antes de utilizarlo.</p> <p><b>FR - Taches tenaces</b>          Tamponnez les taches avec un chiffon humide et un peu de liquide vaisselle.          Essuyez l'excès d'eau avec un tissu propre.          Laissez sécher complètement à l'air avant réutilisation.</p> <p><b>IT - Macchie resistenti</b>          Pulisci la macchia con un panno umido e un goccio di detersivo lavapiatti.          Asciuga l'acqua in eccesso tramite un panno asciutto.          Lascia che il materiale si asciughi completamente all'aria aperta prima dell'utilizzo.</p>

**EN - Additional Tips**

Vacuum to remove any loose crumbs or dirt.

Have a pet? Use a lint roller to gather up any fur.

**DE - Zusätzliche Tipps:**

Lose Krümmel, Schmutz oder Staub durch einfaches staubsaugen entfernen.

Haustierhaare können einfach mit Hilfe einer Fusselrolle entfernt werden.

**ES - Extra tips**

Aspire para eliminar las migas sueltas o la suciedad.

Tiene mascota? utilice un rodillo para pelusas para remover los cabellos.

**FR - Autres conseils**

Retirez à l'aide d'un aspirateur les miettes et saletés.

Si vous avez un animal, utilisez un rouleau anti-peluche pour ramasser les poils.

**IT - Suggerimenti**

Passa l'aspirapolvere per rimuovere ogni briciola rimasta o polvere.

Hai animali domestici? Usa una spazzola adesiva per raccogliere tutti i peli.

**EN - Preventative Care**

Potate pillows and cushions monthly to ensure even wear.

Avoid placing your piece in direct sunlight to prevent fading.

Add a slipcover. Most are machine-washable and can change up your style!

**DE - Vorbeugende Pflege**

Durch regelmäßiges Wenden der Kissen und Polster können Sie eine vorzeitige Abnutzung vermeiden.

Vermeiden Sie, ihr Möbelstück direkter Sonneneinwirkung auszusetzen. Dies verhindert ein Ausbleichen des Stoffes.

Ein passender Schutzbezug verhindert starke Verschmutzung, ist zudem meist maschinenwaschbar und auch geeignet um den Stil zu verändern!

**ES - Cuidados preventivos**

Rote las almohadas y los cojines mensualmente para asegurar un desgaste uniforme.

Evite colocar sus piezas bajo la luz directa del sol para evitar el deterioro.

Utilice una funda para cubrir. Las fundas pueden ser lavadas con máquina y pueden cambiar su estilo.

**FR - Soins préventifs**

Retournez les coussins une fois par mois pour une usure uniforme.

N'exposez pas votre produit à la lumière directe du soleil afin d'éviter une décoloration.

Ajoutez une housse: la plupart sont lavables en machine et vous permettent de changer de style.

**IT - Prevenzione**

Gira i cuscini mensilmente per evitare maggiore usura.

Si prega di evitare di porre il prodotto sotto la luce del sole, in modo da evitarne lo sbiadimento.

Aggiungi una fodera. La maggior parte delle fodere sono lavabili in lavatrici e possono migliorare il vostro stile.