

Assembly Instructions

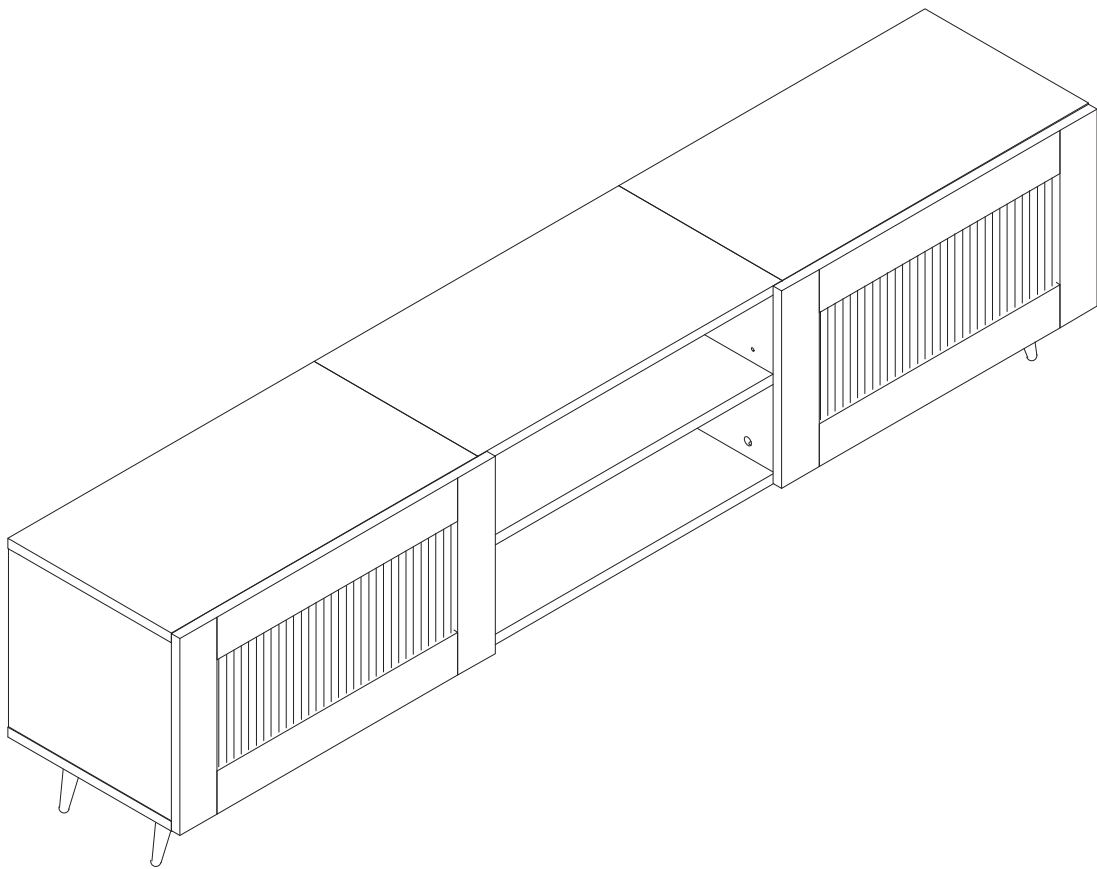

CUSTOMER CARE



**Congratulations
Happy shopping**
Feel free to share with your friends or family
Thank you for your 5-star feedback and positive
reviews to help others
Good advice leads to the best service

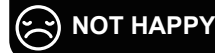

**We apologize for the bad shopping experience
Any defects, broken, missing pieces, delays or
accidents Please contact us as soon as possible
online email or official email are available.**

ITEM SPECIFICATION

SKU	Product Dimension	Package Dimension	Color
A	62.99*11.81*15.75 in	30.71*15.75*9.65 in	White
B	62.99*11.81*15.75 in	30.71*15.75*9.65 in	Black

NOTICE:

Basic precautions should always be followed when using this product. Please read all instructions before using the cabinet and retain the education for future reference.

Failure to observe all instructions and warnings may cause severe property damage or personal injuries.

When unpacking, please be careful don't cut too deep to damage the products in the box. Just use the blade to scratch the parcel tape.

Check the product and hardware accessories in the box; and confirm whether the instructions are complete.

When installing, please pay attention to the protection of the parts. The soft material must be placed under the product, and please carefully handle it to avoid surface damage.

After the assembly is completed, please adjust the placement position according to the actual situation.

Keep children away from cabinets, accessories, and installation tools. They are at risk of injury to the child.

Two people are recommended for assembly.

If you need the electronic manual, please contact our customer service to get it.

RETURN/DAMAGE CLAIM INSTRUCTIONS:

The product is shipped in a single carton box. If you haven't received the package or need to know the tracking of the package, get in touch with us immediately via message or contact us.

If the package is damaged, please get in touch with us from the very beginning. Attaching a damaged photo is appreciated.

The product accepts returns within 30 days without any reason. If you return this item for personal reasons, you must cover the return fee and order processing fee (0- 20% restocking fee based on the invoice price). We will cover the freight if the product has quality issues (not caused by humans).

Please keep the original box if you need to return the goods. Please use our return label and do not return it without permission.

If you return the product after 30 days of receiving it, we are afraid your return application won't be accepted. We appreciate your understanding.

Any damages, defects and parts missings during installation, pls contact us from the very beginning. Replacement, exchange and refund will be arranged ASAP except of personal reasons.





Part List

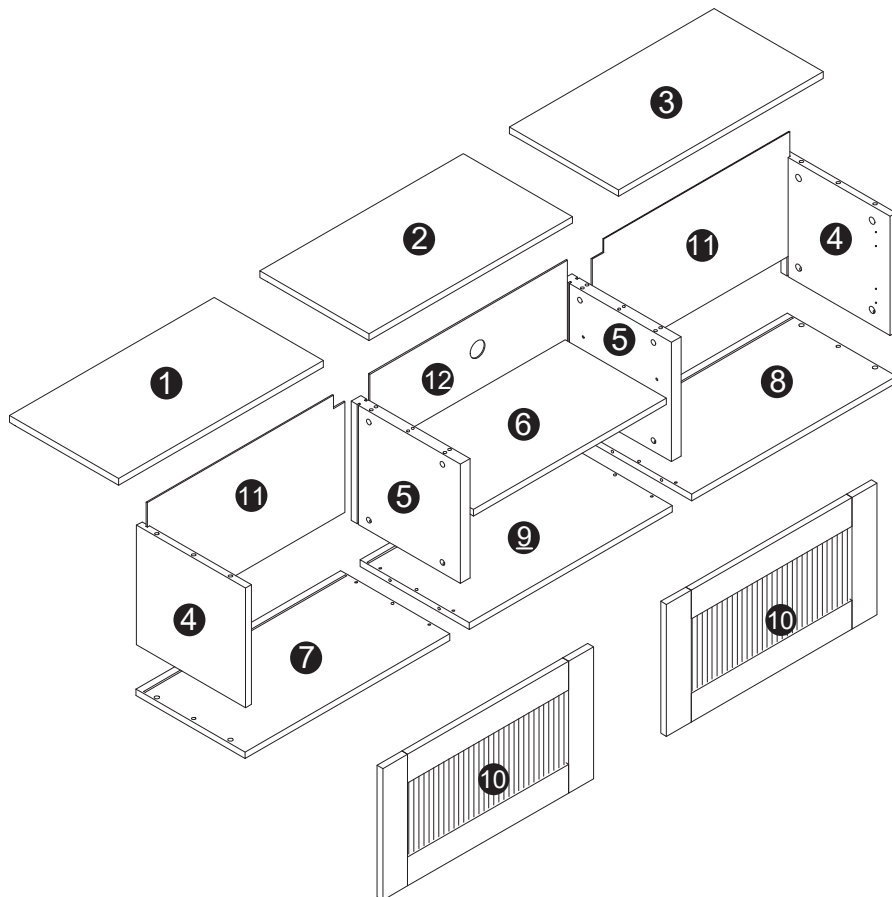
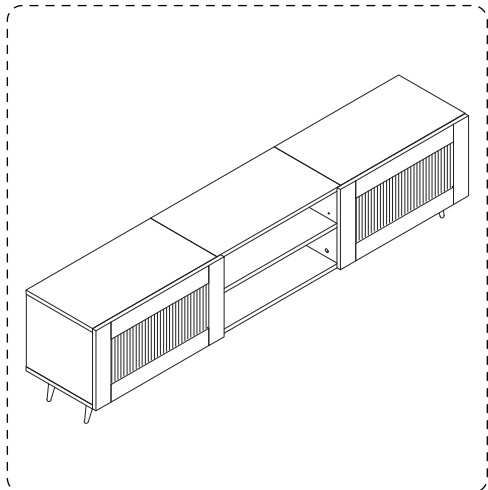

Open the package, and put the item on the mat with care. Please install it carefully to ensure your fingers will not be scratched.

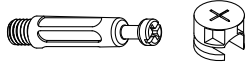
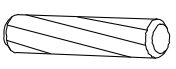
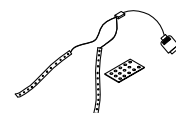
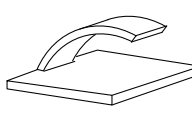
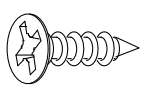
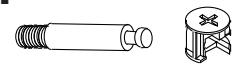
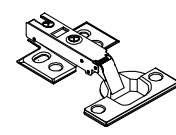

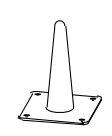
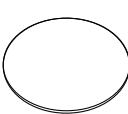
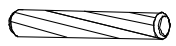
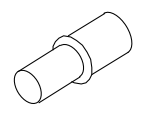
Hardware List

<p>A</p>  <p>$\phi 15 \times 12 \text{mm}$ M6*40mm ×8 (+1)</p>	<p>B</p>  <p>M8*30mm ×4 (+1)</p>	<p>K</p>  <p>220cm ×1</p>	<p>L</p>  <p>×6 (+1)</p>
<p>M</p>  <p>M3.5*14mm ×56 (+1)</p>	<p>H</p>  <p>M5*24mm $\phi 12 \times 10 \text{mm}$ ×16 (+1)</p>	<p>D</p>  <p>×4</p>	<p>J</p>  <p>×8 (+1)</p>
<p>X</p>  <p>×4</p>	<p>Y</p>  <p>×2</p>	<p>T</p>  <p>×24 (+1)</p>	<p>S</p>  <p>M6*30mm ×12 (+1)</p>
<p>Z</p>  <p>×4 (+1)</p>	<p>Extra white cam</p>  <p>×2</p>		

Start...

| Step1

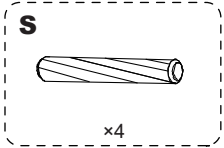

Make sure the Wooden Dowel Pins is fully immersed in the holes to avoid causing the top of the panel to penetrate during the next step of installation.

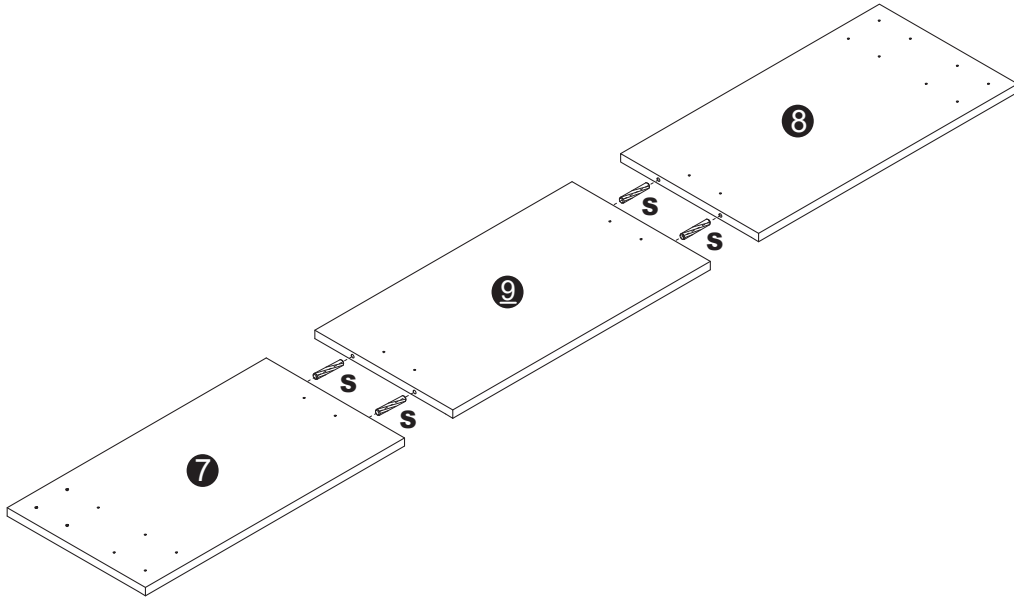
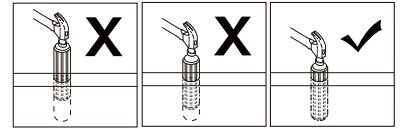

| Step2

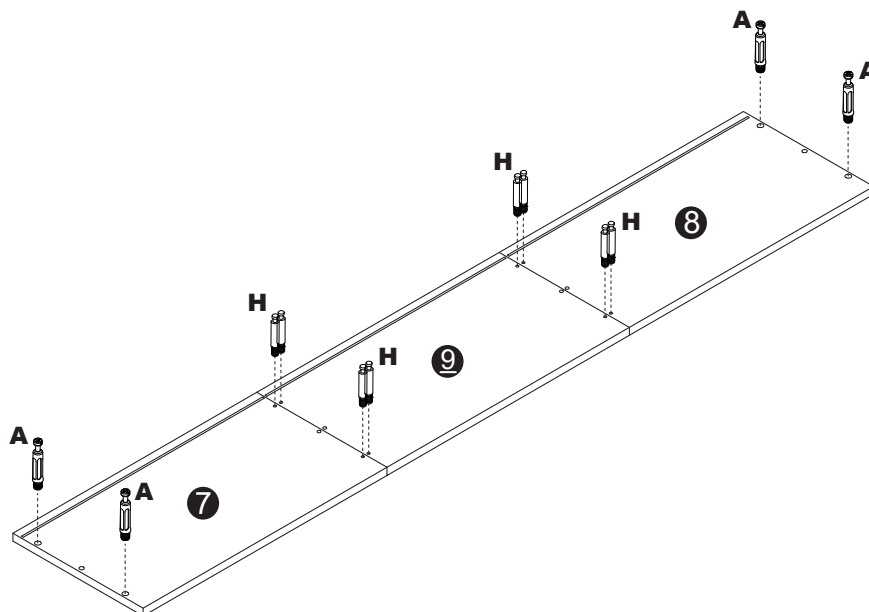
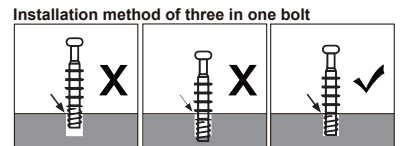
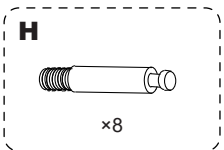
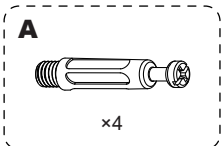

Step 3

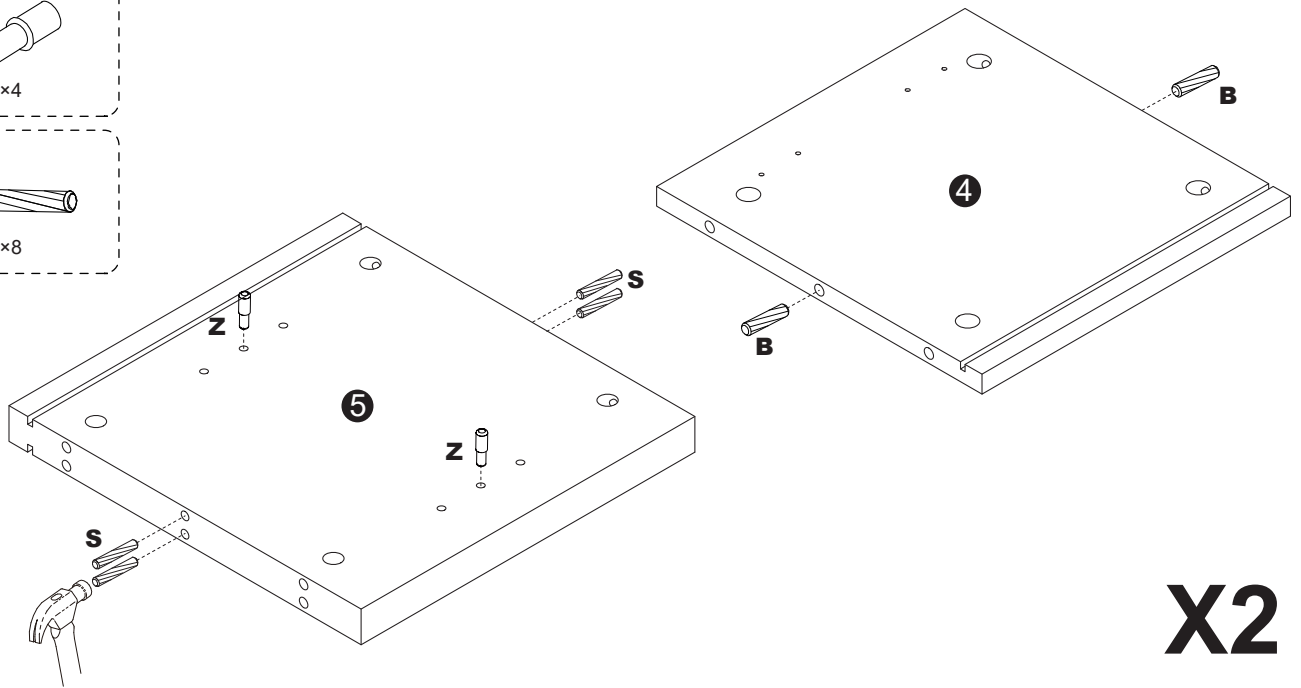
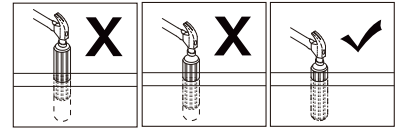
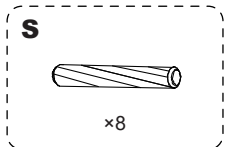
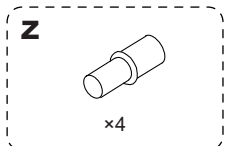
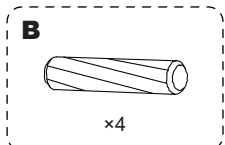

Step 4

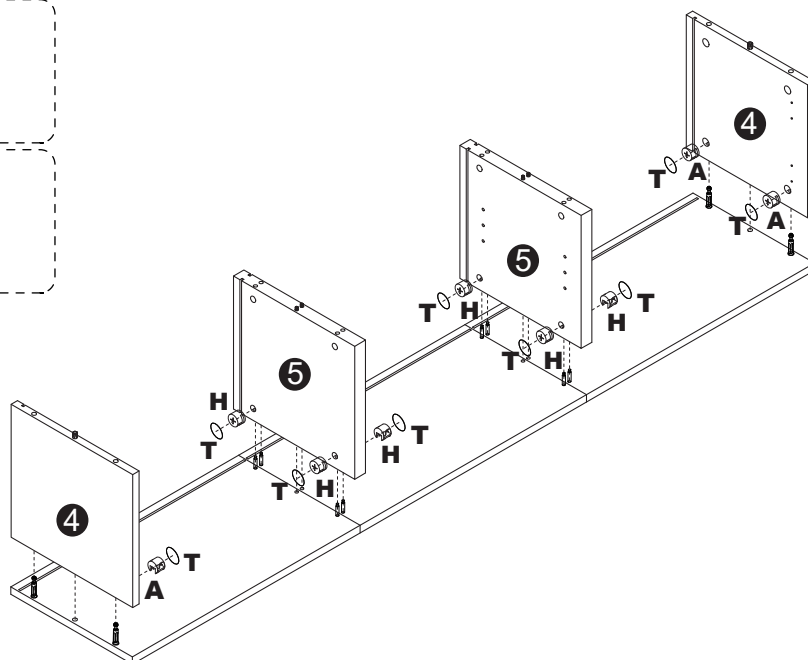
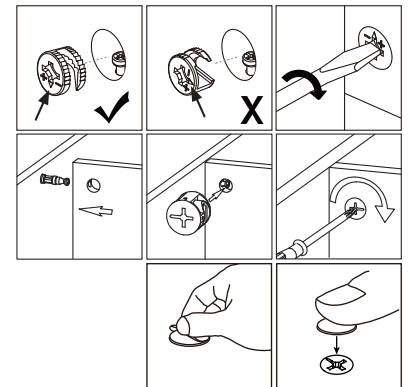
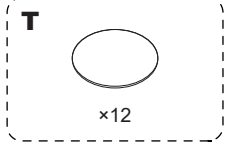
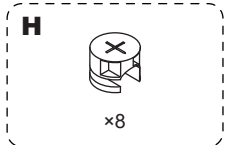
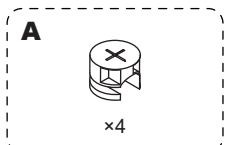

| Step5

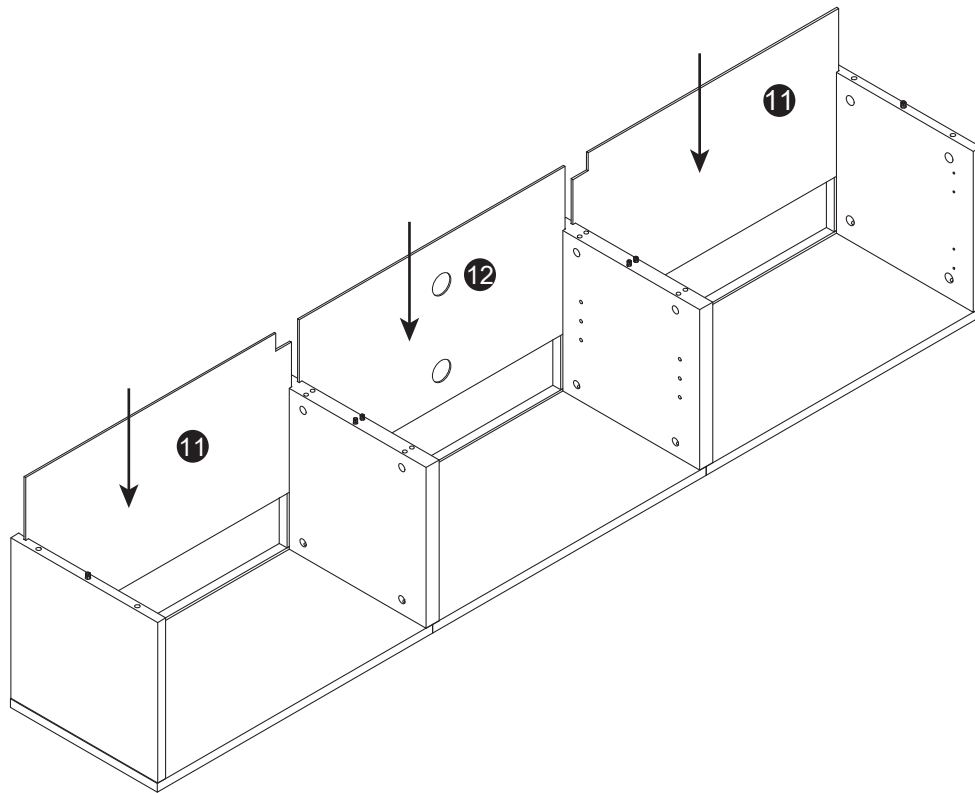

| Step6

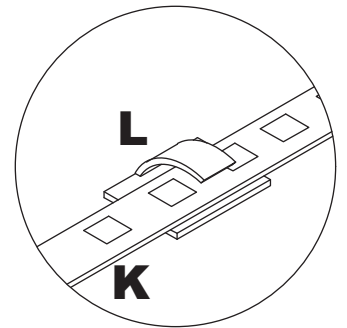
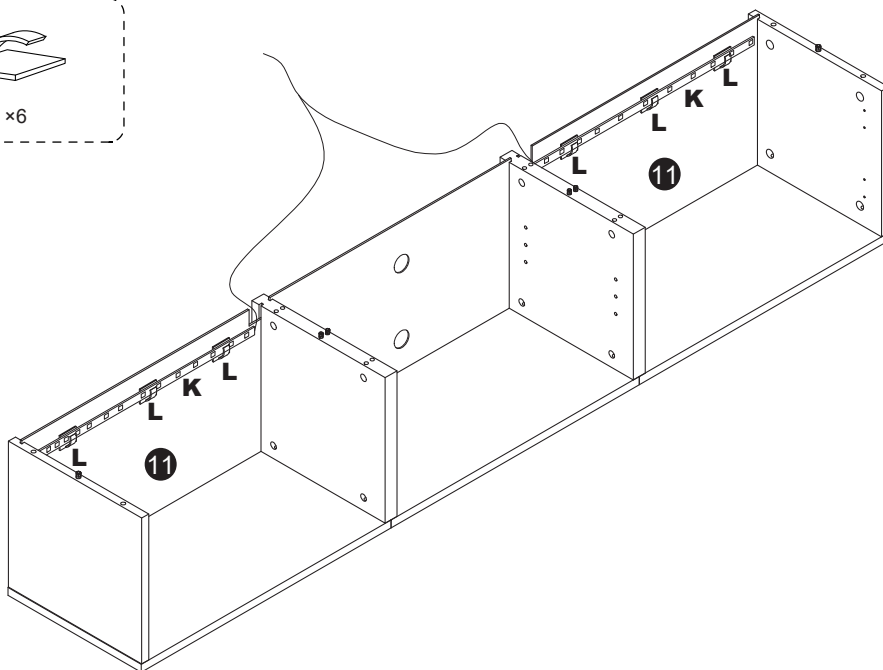
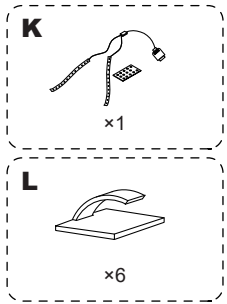

Step 7

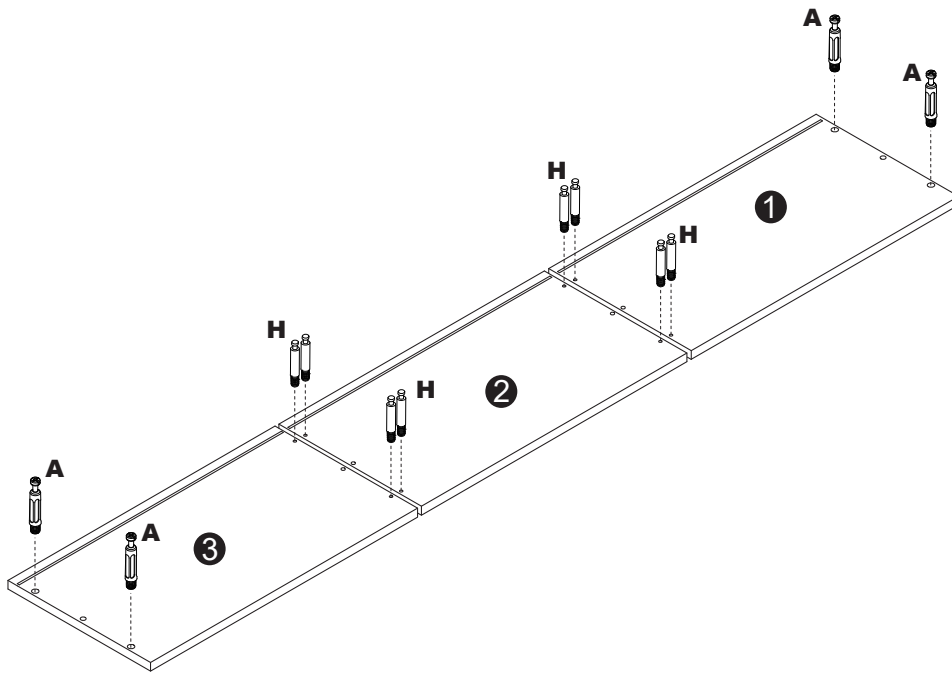
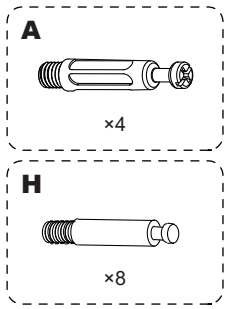

Step 8

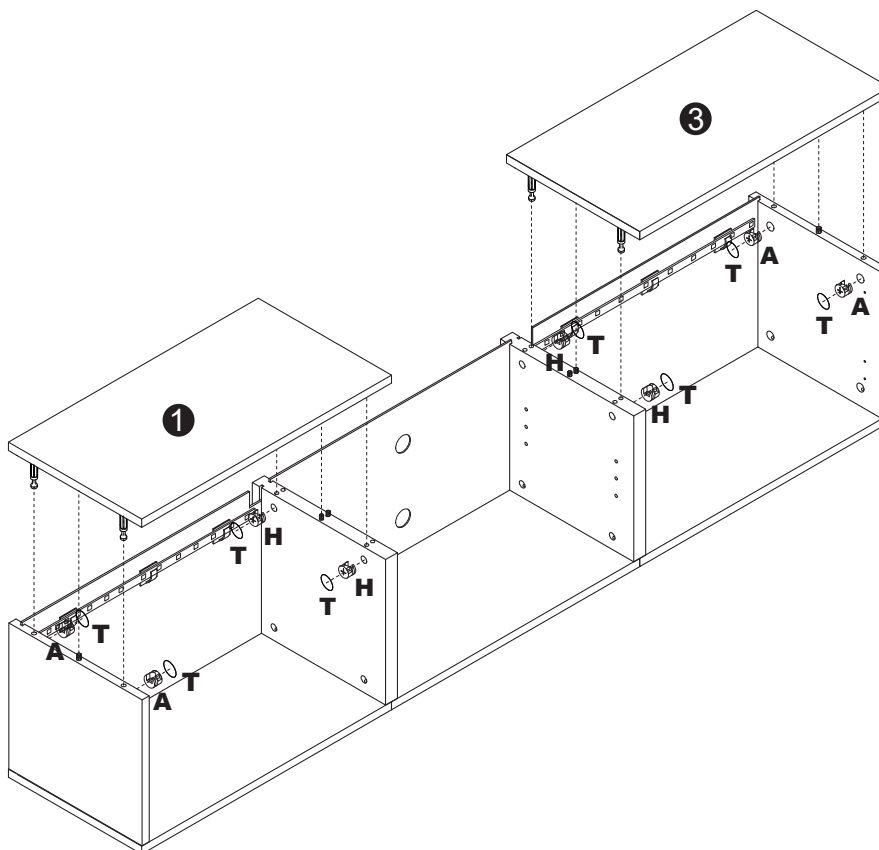
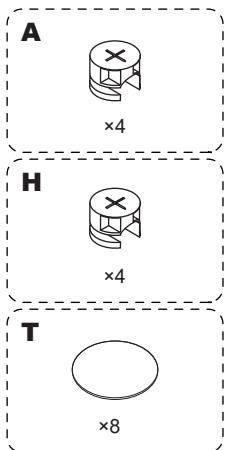

| Step 9

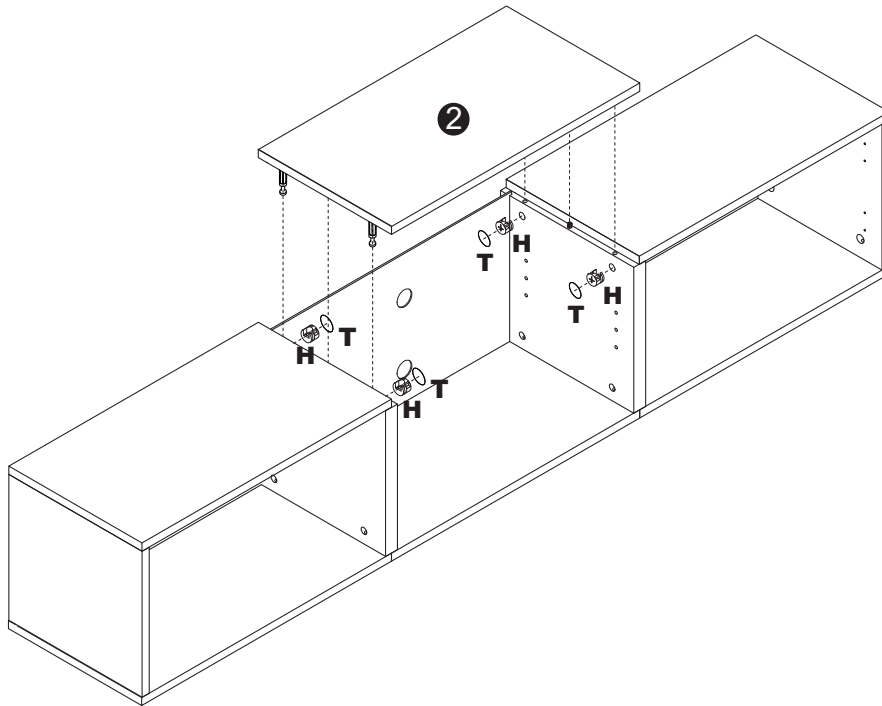
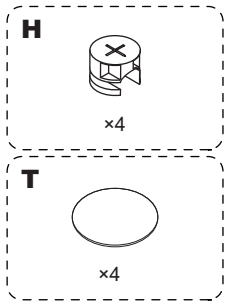

| Step 10

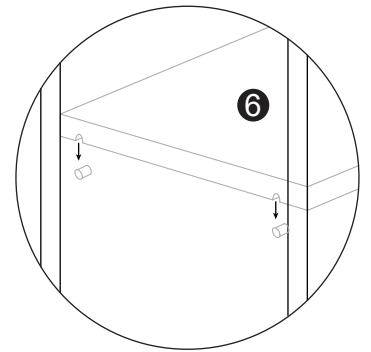
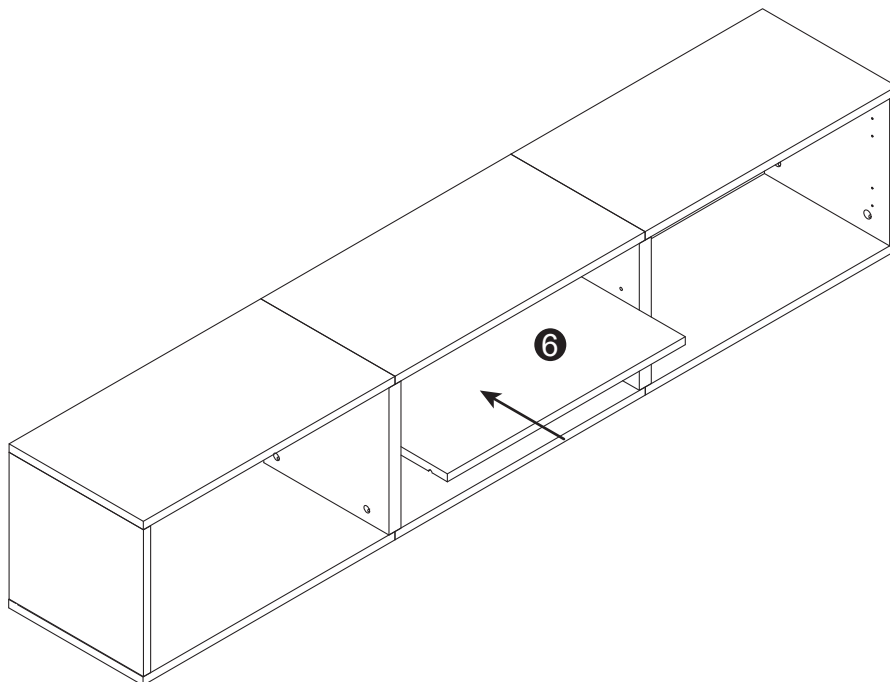

Step 11

X2

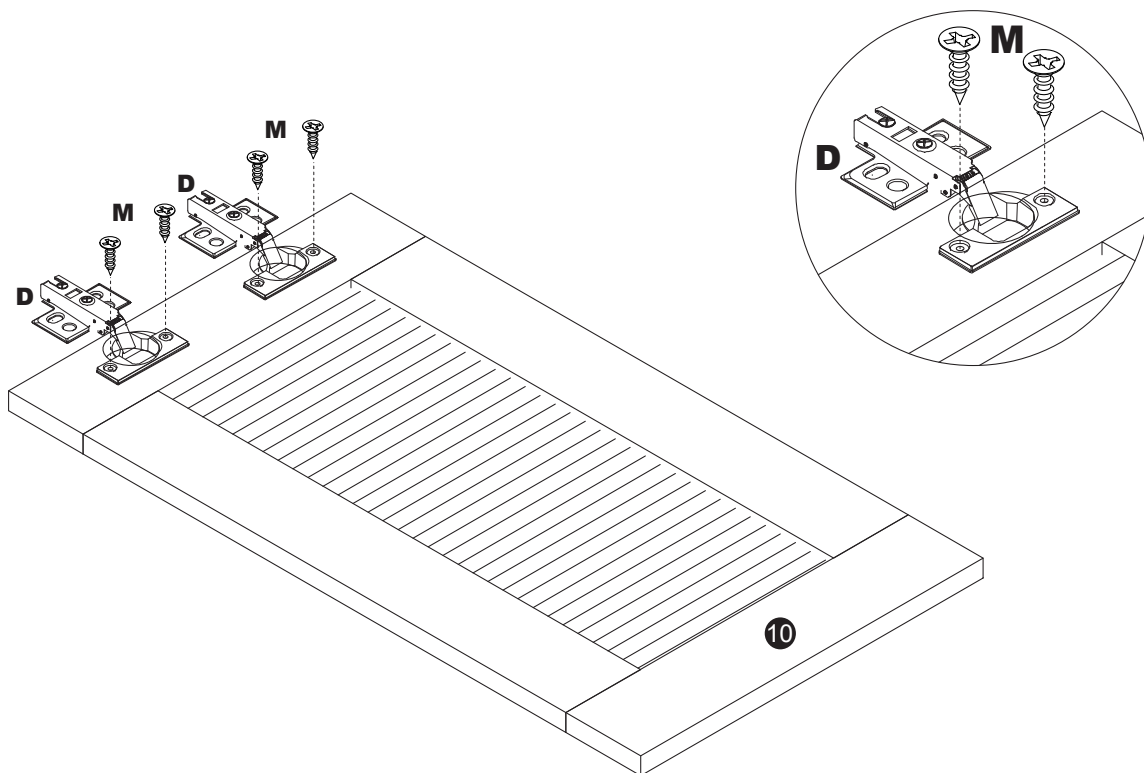
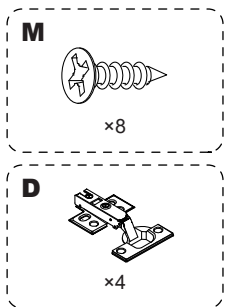

Step 12

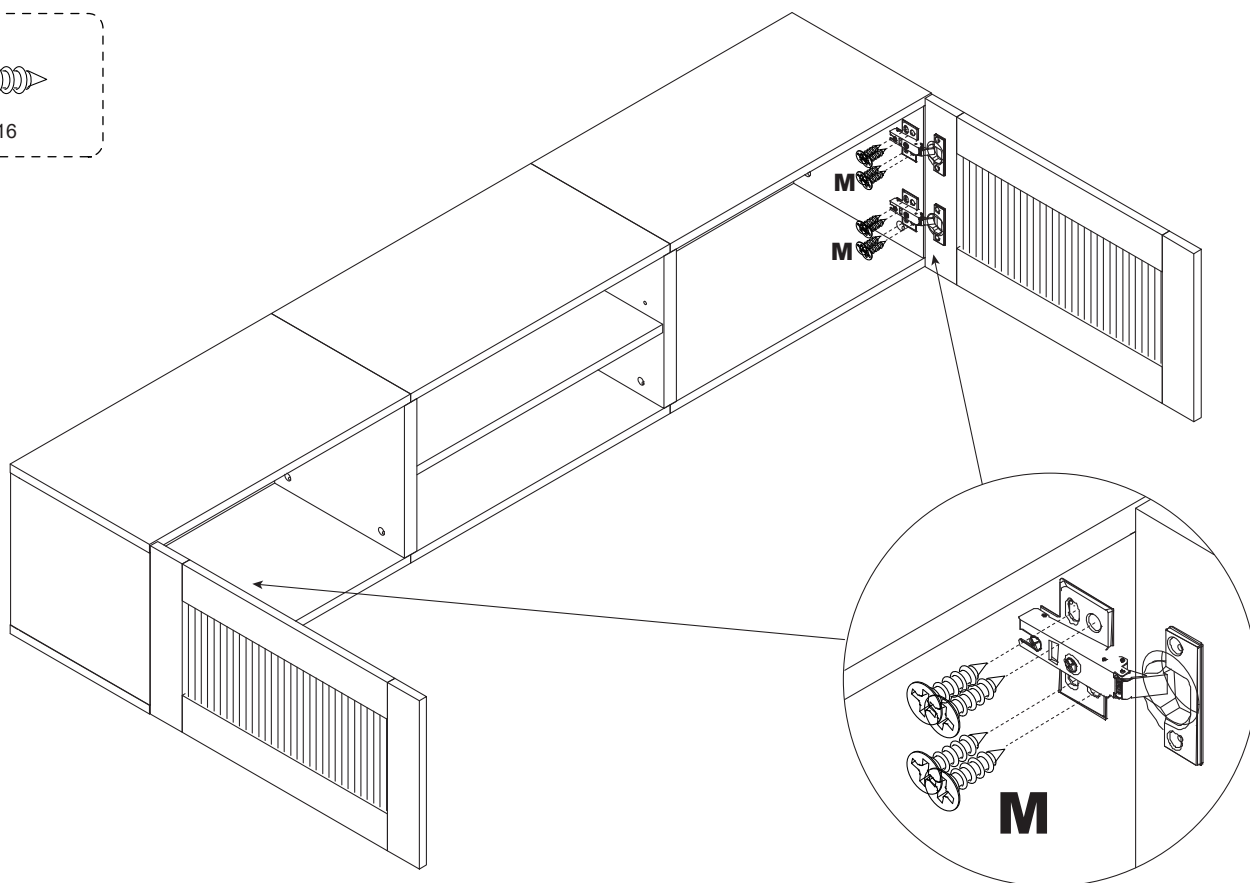
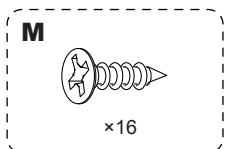

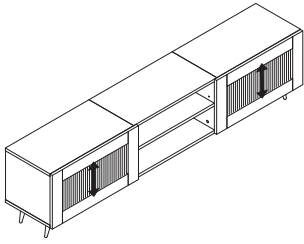

Hinge adjustment

A: To move doors up or down:
Loosen screws shown and move doors to suit.
Once doors are aligned, re-tighten screws.

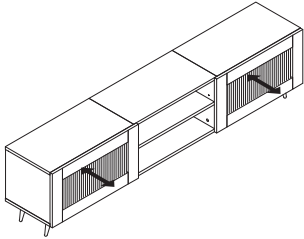
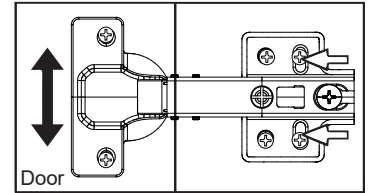

Hinge adjustment

B: To move doors in or out:
Loosen screw shown and move doors to suit.
Re-tighten screws.

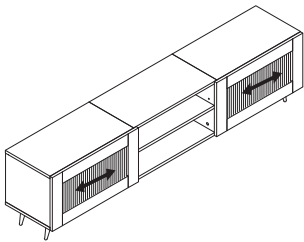
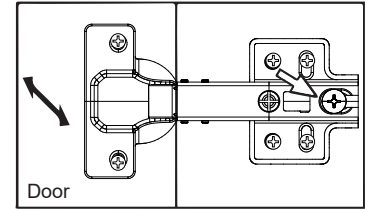

Hinge adjustment

C: To move doors left or right:
Loosen screw shown and move doors to suit.
Re-tighten screws.

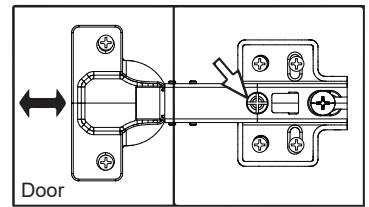

Step 13

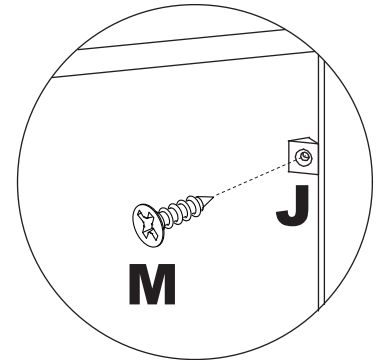
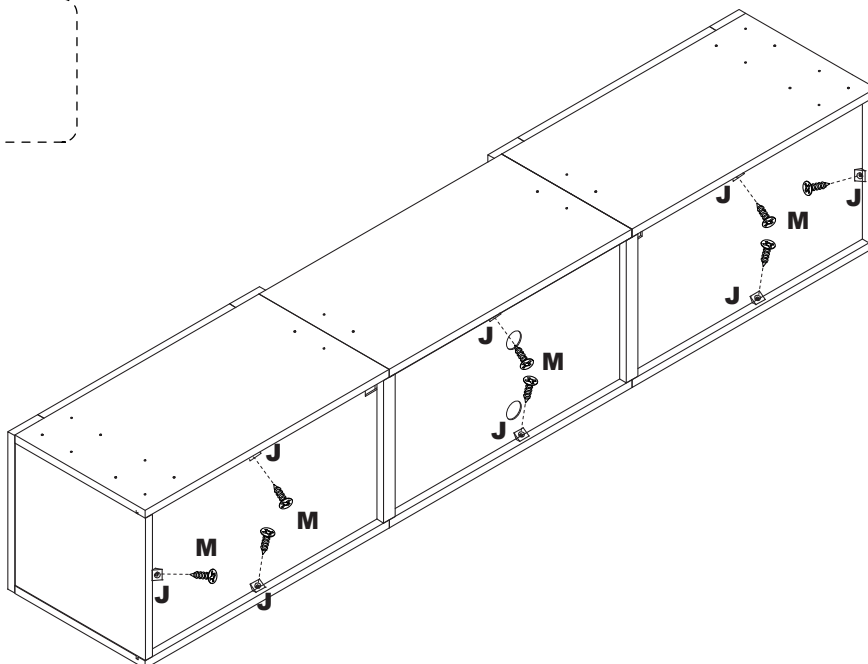
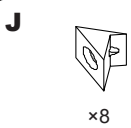
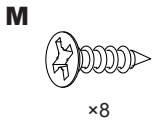

Step 14

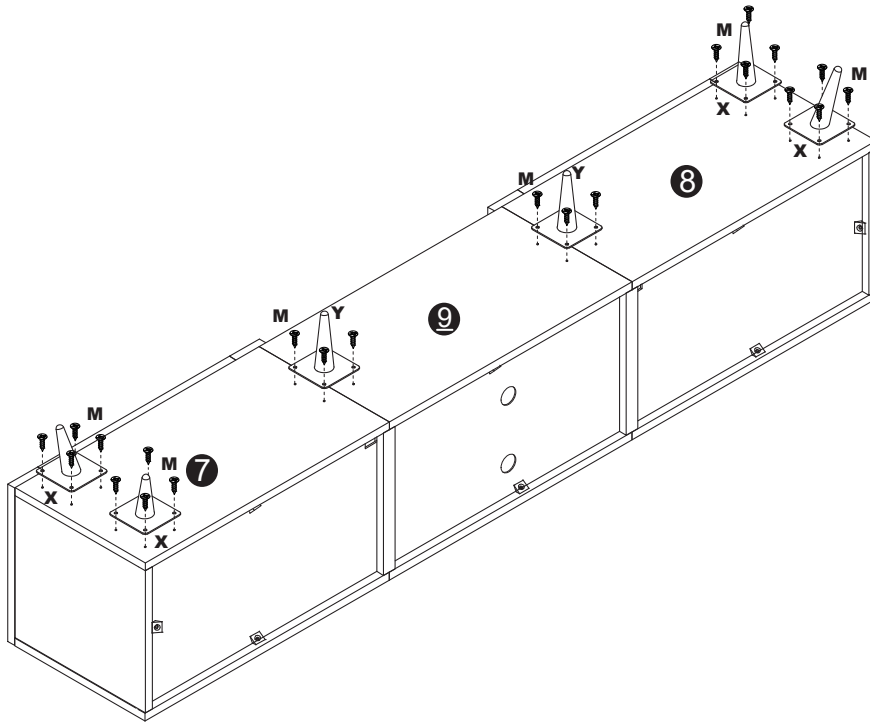
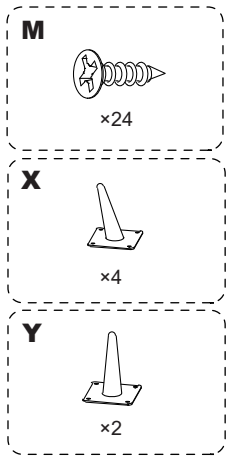

LED LIGHTS OPERATION MANUAL

1 Power on

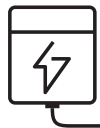
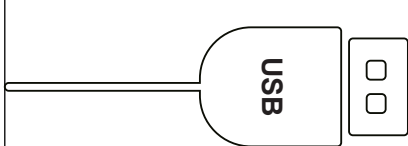

Portable Charger

Power Strip

PC Computer

2 Remove the plastic insulation from the bottom of the remote control

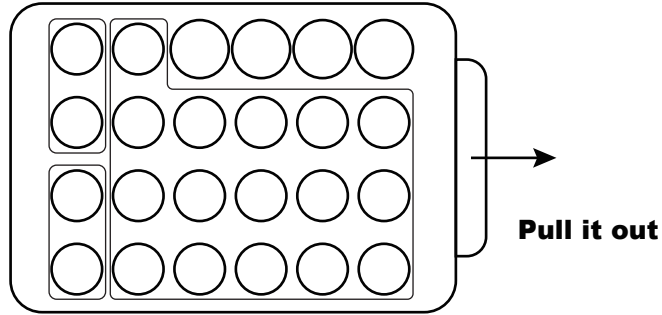

3 Light color and mode

Static red

Static orange

Static dark yellow

Static yellow

Static straw yellow

Static green

Static pea green

Static cyan

Static light blue

Static sky blue

Static blue

Static dark blue

Static brown

Static pink

Static purple

Static white

7 color jumpy change All fade out&fade in 7 color fade change 3 base color jumpy

4 Remote Control

Brightness/Speed +

Brightness/Speed -

Static monochrome
Shortcut button
Press the button
Corresponding color

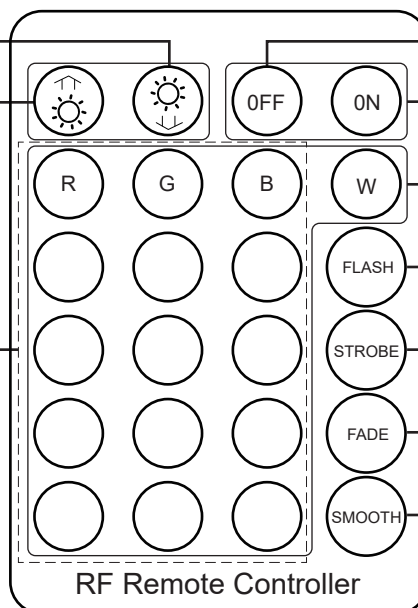

OFF

ON

The static effect of white

Jump effect

Stroboscopic effect

Gradient effect

Smooth, gradual

RF Remote Controller

LIMITED WARRANTY

The furniture team would like to improve customer service quality and make your experience smooth.

Return Policy: we accept returns within 30 days without any significant reason. After we receive the returned item, we will check it and make sure that it is not damaged, then we will process the refund. For more details, please check the above terms of RETURN/DAMAGE CLAIM INSTRUCTIONS.

Any damages, defects and parts missings during installation, pls contact us from the very beginning. Replacement, exchange and refund will be arranged ASAP except of personal reasons.

The exceptions or exclusions to this warranty are as follows:

1. We do not accept claims outside of a limited period.
2. This warranty does not include the products purchased by mistake.
3. Any damages, broken, missing parts, we will repair or replace them without charging you any cost within a reasonable period. We reserve the right to require damaged parts to be returned to us upon our request.

If you have any questions concerning this warranty, please get in touch with the Customer Service department. Be prepared to provide your name, address, daytime phone number, the product's model and purchase order number, the date of purchase, and the store name. All the information you provided will help us track your order quickly and solve your problem in the shortest time. This warranty gives you specific rights, and you still possess other rights that vary in each case.