

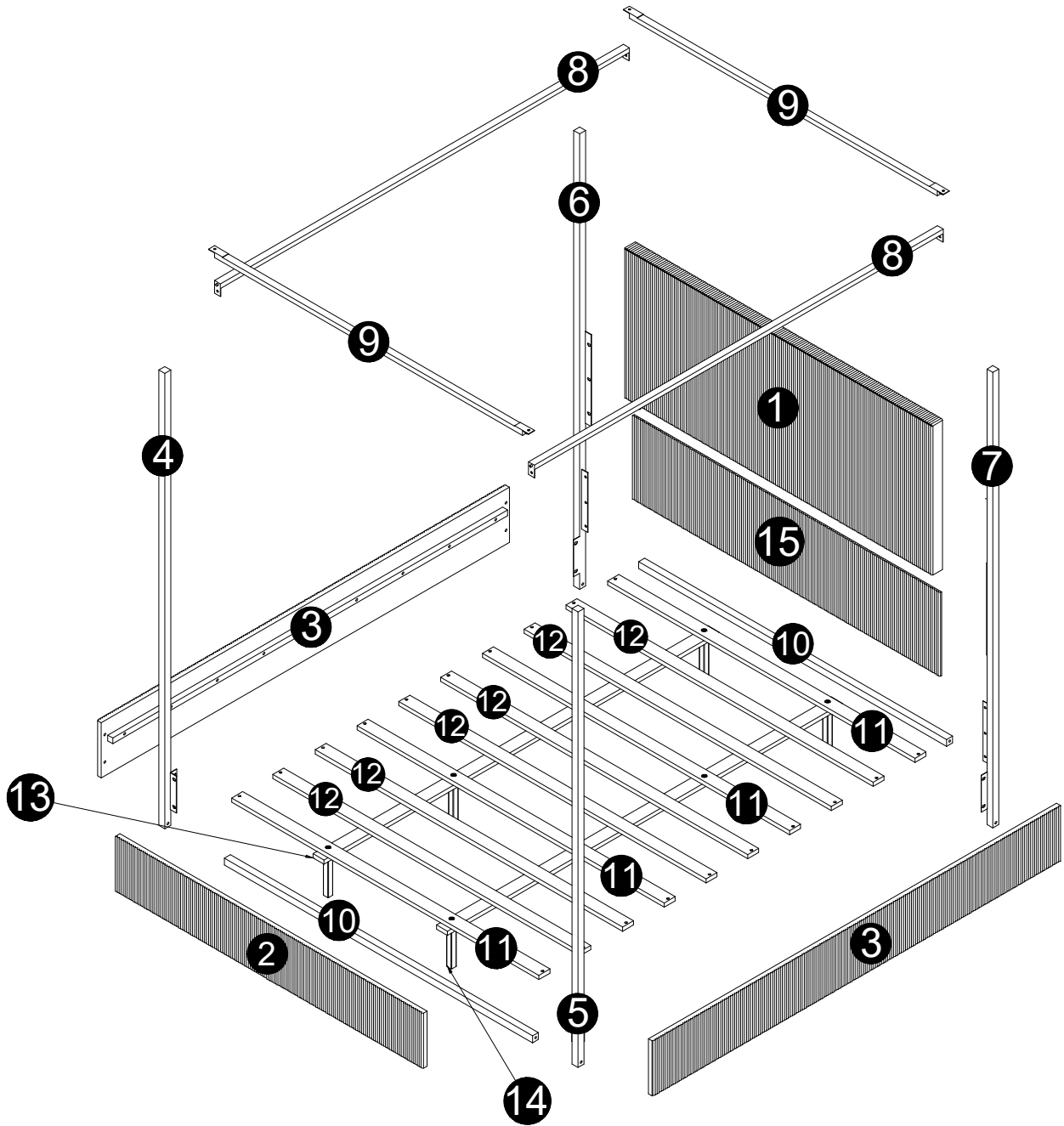







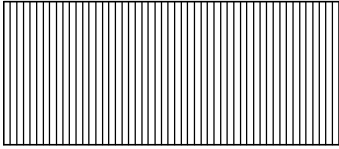
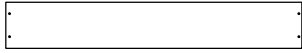
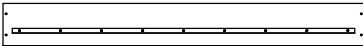

**ASSEMBLY INSTRUCTIONS
INSTRUCTIONS DE MONTAGE**

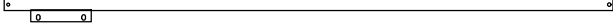

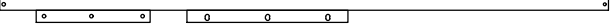
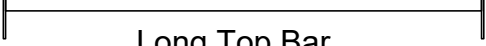
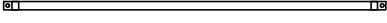
PARTS
LES PIÈCES

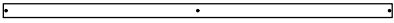
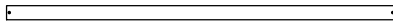

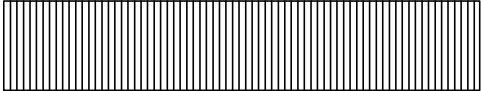



BOX:1/1

check that you've received all parts
listed below
vérifiez que vous avez reçu toutes les
pièces répertoriées ci-dessous



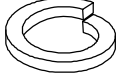
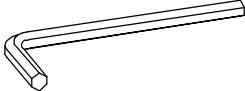
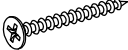

<p>1 (1PC)</p>  <p>Head Board Tête de lit</p>	<p>2 (1PC)</p>  <p>Foot Board Planche à pied</p>
<p>3 (2PCS)</p>  <p>Side Board Panneau latéral</p>	<p>4 (1PC)</p>  <p>Bed Footboard Post poteau de pied de lit</p>
<p>5 (1PC)</p>  <p>Bed Footboard Post poteau de pied de lit</p>	<p>6 (1PC)</p>  <p>Bed Headboard Post poteau de tête de lit</p>
<p>7 (1PC)</p>  <p>Bed Headboard Post poteau de tête de lit</p>	<p>8 (2PCS)</p>  <p>Long Top Bar Longue barre en haut</p>
<p>9 (2PCS)</p>  <p>Short Top Bar barre courte en haut</p>	<p>10 (2PCS)</p>  <p>bottom reinforcement renfort inférieur</p>
<p>11 (4PCS)</p>  <p>Slats Lattes</p>	<p>12 (6PCS)</p>  <p>Slats Lattes</p>
<p>13 (2PCS)</p>  <p>Support Slat Latte de support</p>	<p>14 (8PCS)</p>  <p>Support Legs Jambes de soutien</p>
<p>15 (1PC)</p>  <p>Support Bar Bar de soutien</p>	<p>HARDWARE</p> 

HARDWARE LIST

LISTE DU MATÉRIEL



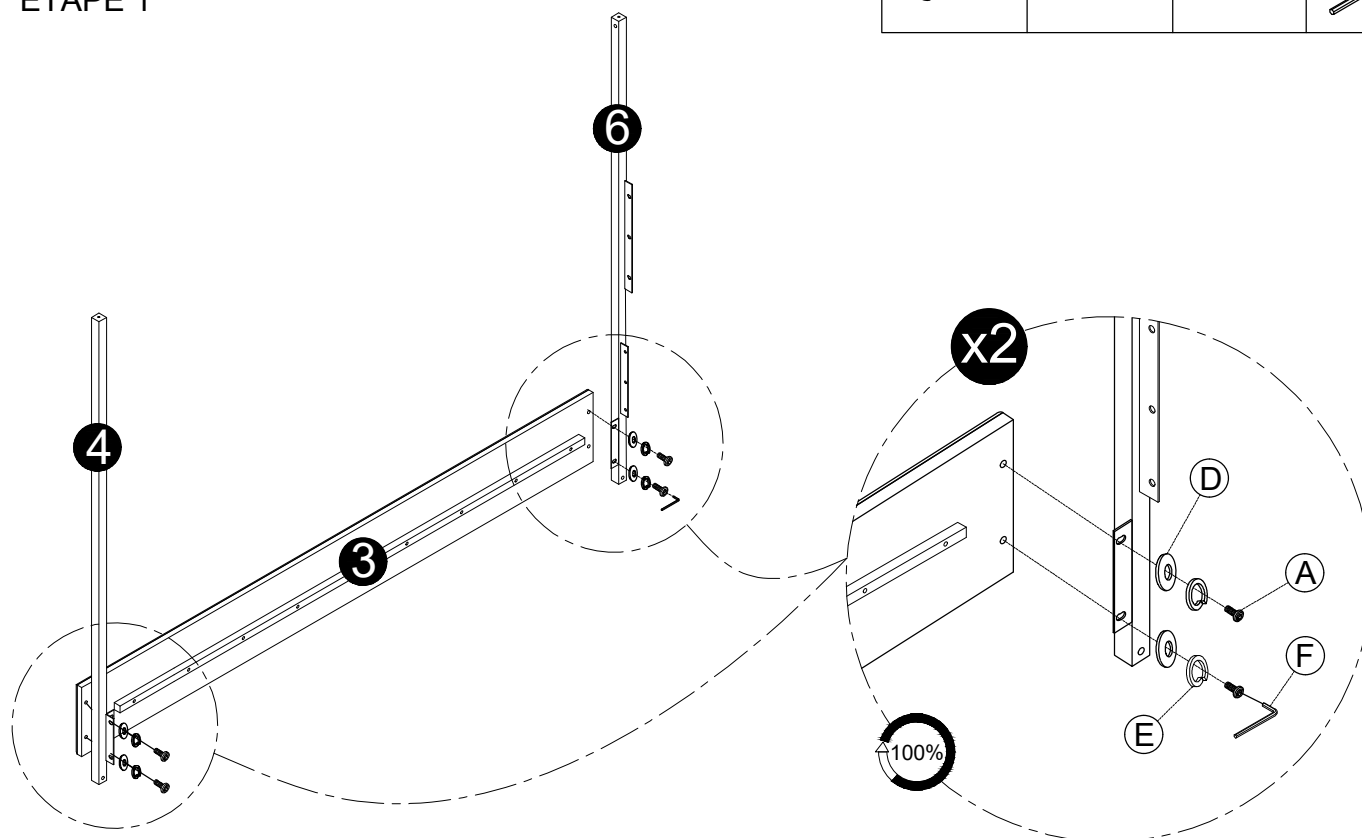

NO	OUTLOOK	DESC	QTY
A		Bolts 5/16*20mm	26 pcs
B		Bolts 5/16*50mm	4 pcs
C		Bolts 5/16*70mm	8 pcs
D		Flat washer Ø19x1.5 mm	38 pcs
E		Spring washer Ø13x1 mm	38 pcs
F		Allen wrench 80x30x4 mm	1 pc
G		Screws Ø4x30 mm	20 pcs
H		L-Bracket 19x19*2 mm	4 pcs
I		Screws Ø4x12 mm	14 pcs

STEP 1
ÉTAPE 1

Ax4 	Dx4 	Ex4 	Fx1 
--	--	--	---





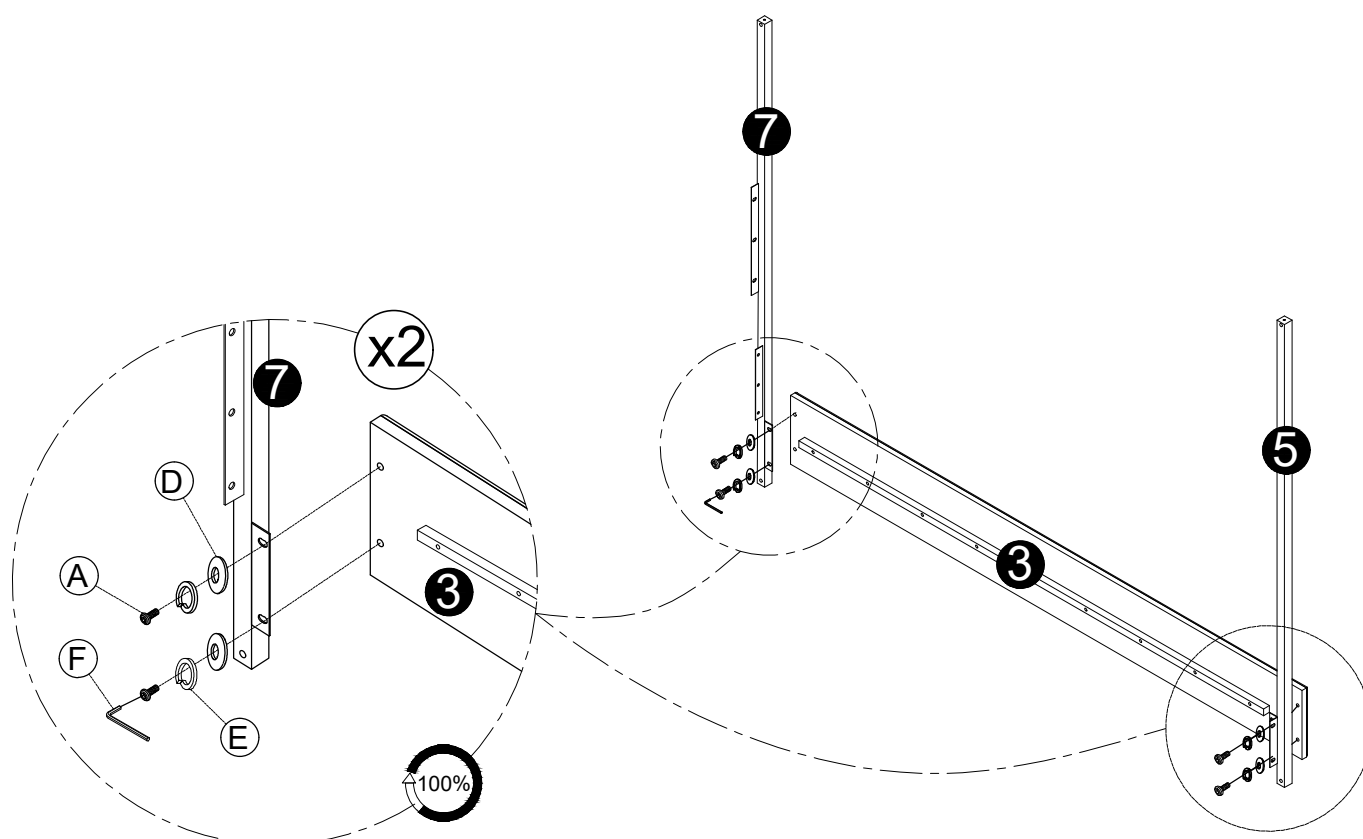

STEP 2
ÉTAPE 2

Ax4 	Dx4 	Ex4 	Fx1 
--	--	--	--





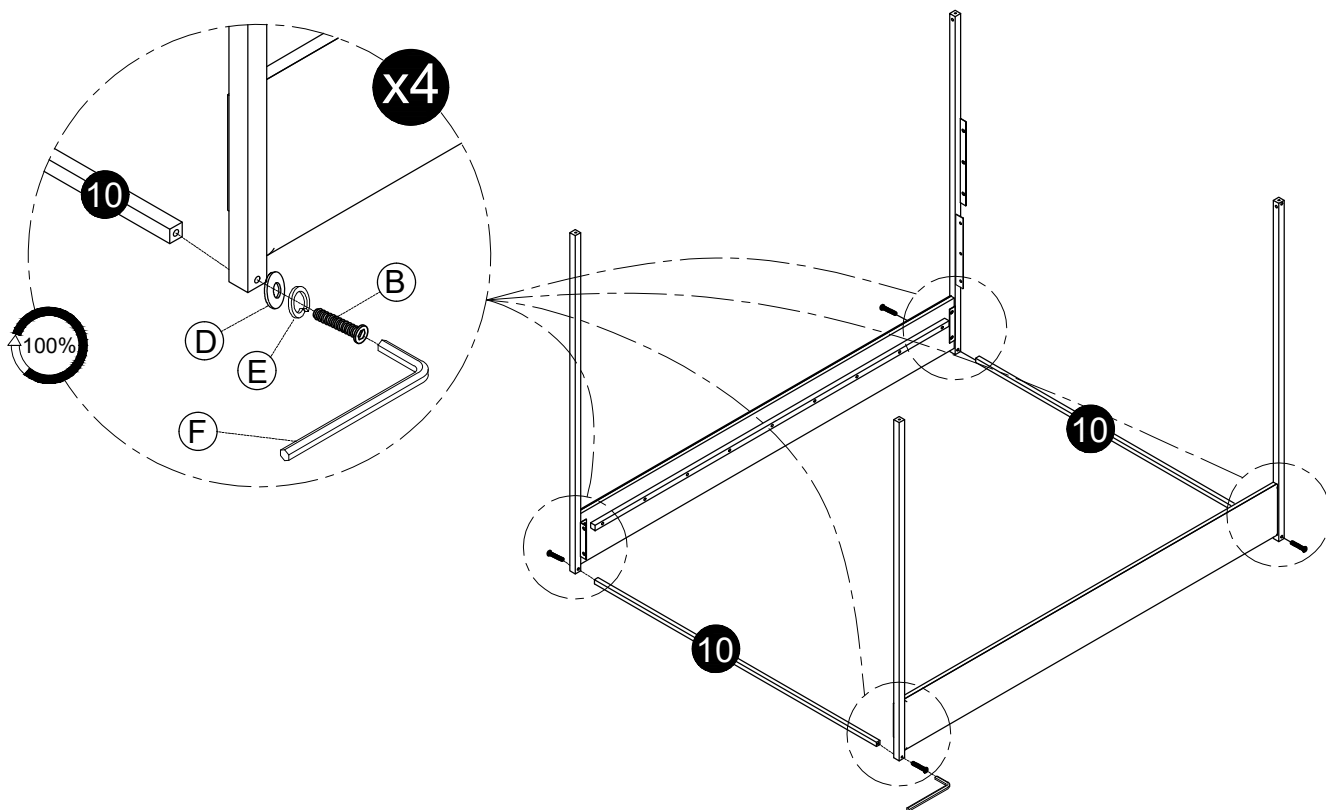

STEP 3
ÉTAPE 3

Bx4	Dx4	Ex4	Fx1
			





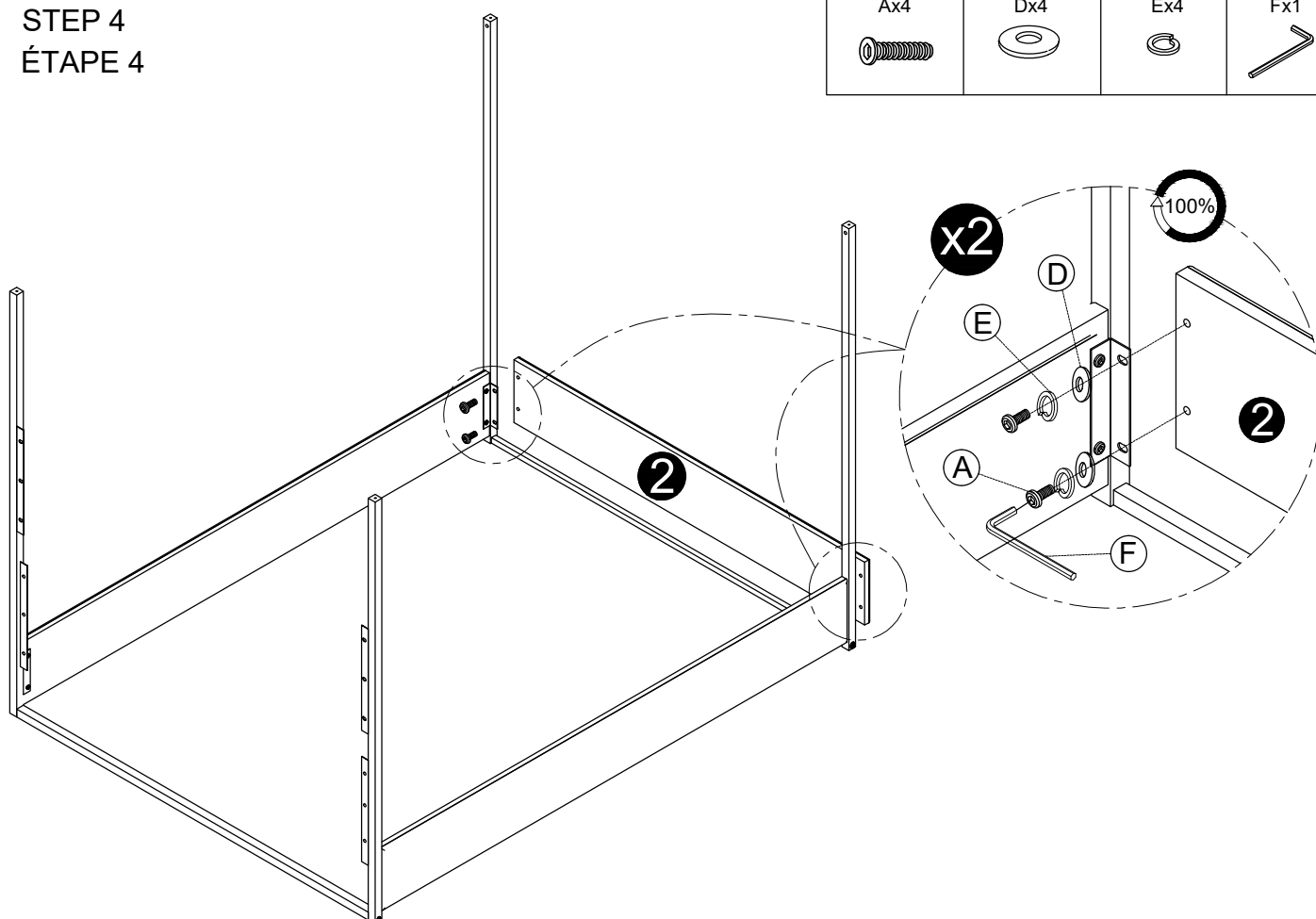

STEP 4
ÉTAPE 4

Ax4	Dx4	Ex4	Fx1
			



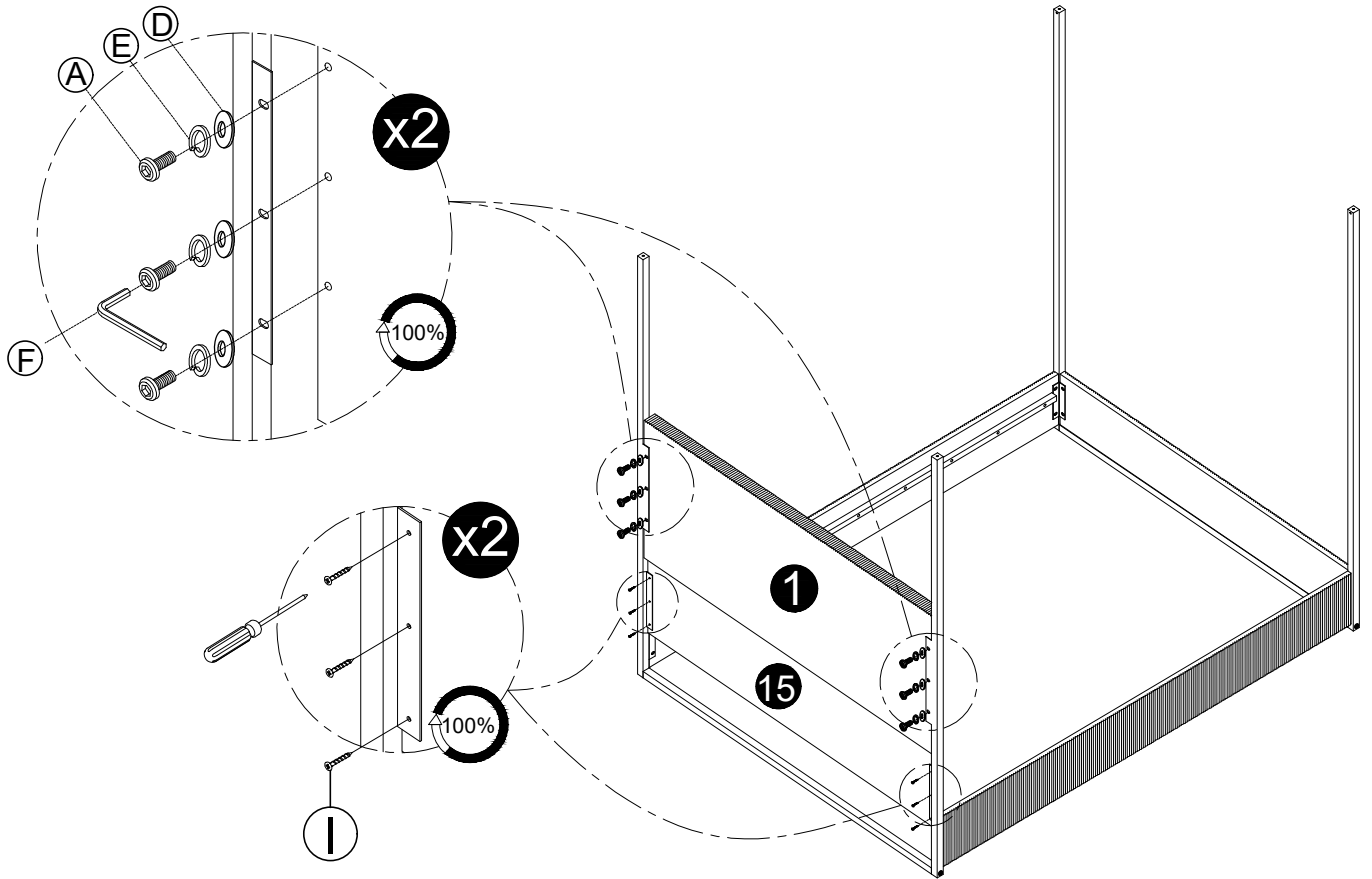

STEP 5
ÉTAPE 5

Ax6 	Dx6 	Ex6 	Fx1 	Ix6 
--	--	--	--	--





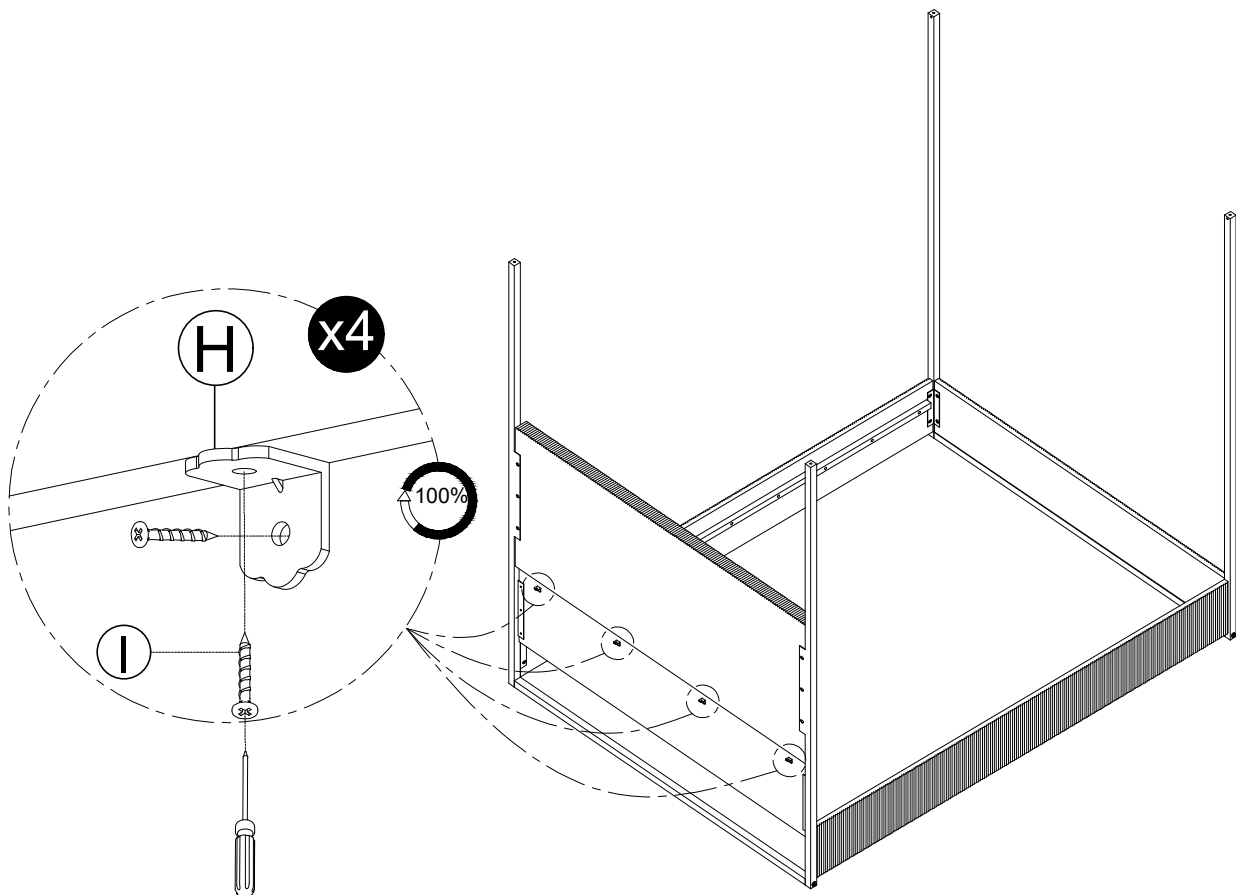

STEP 6
ÉTAPE 6

Hx4 	Ix8 
--	--



STEP 7
ÉTAPE 7

Cx8 	Dx8 	Ex8 	Fx1 	Gx8 
--	--	--	--	--

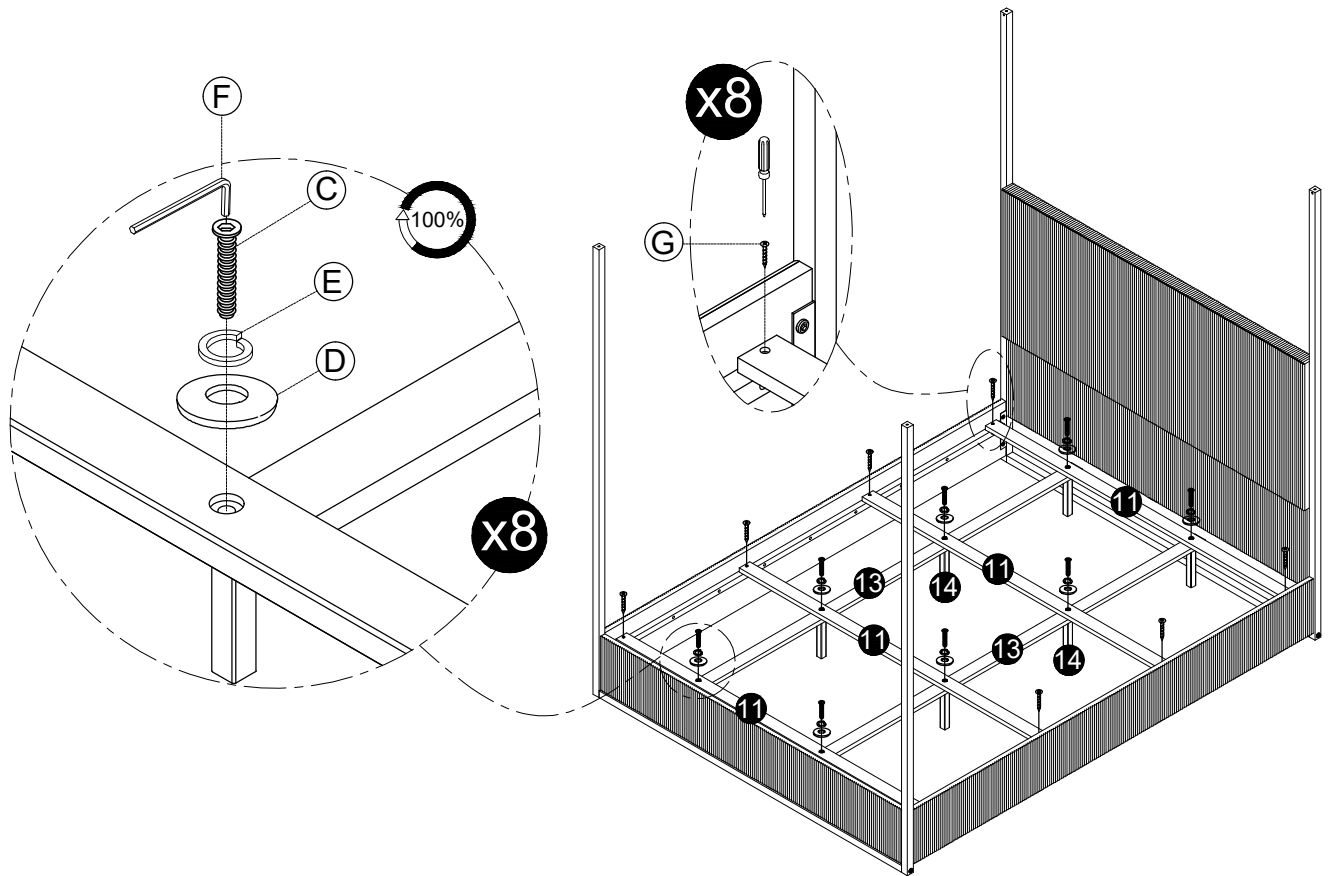



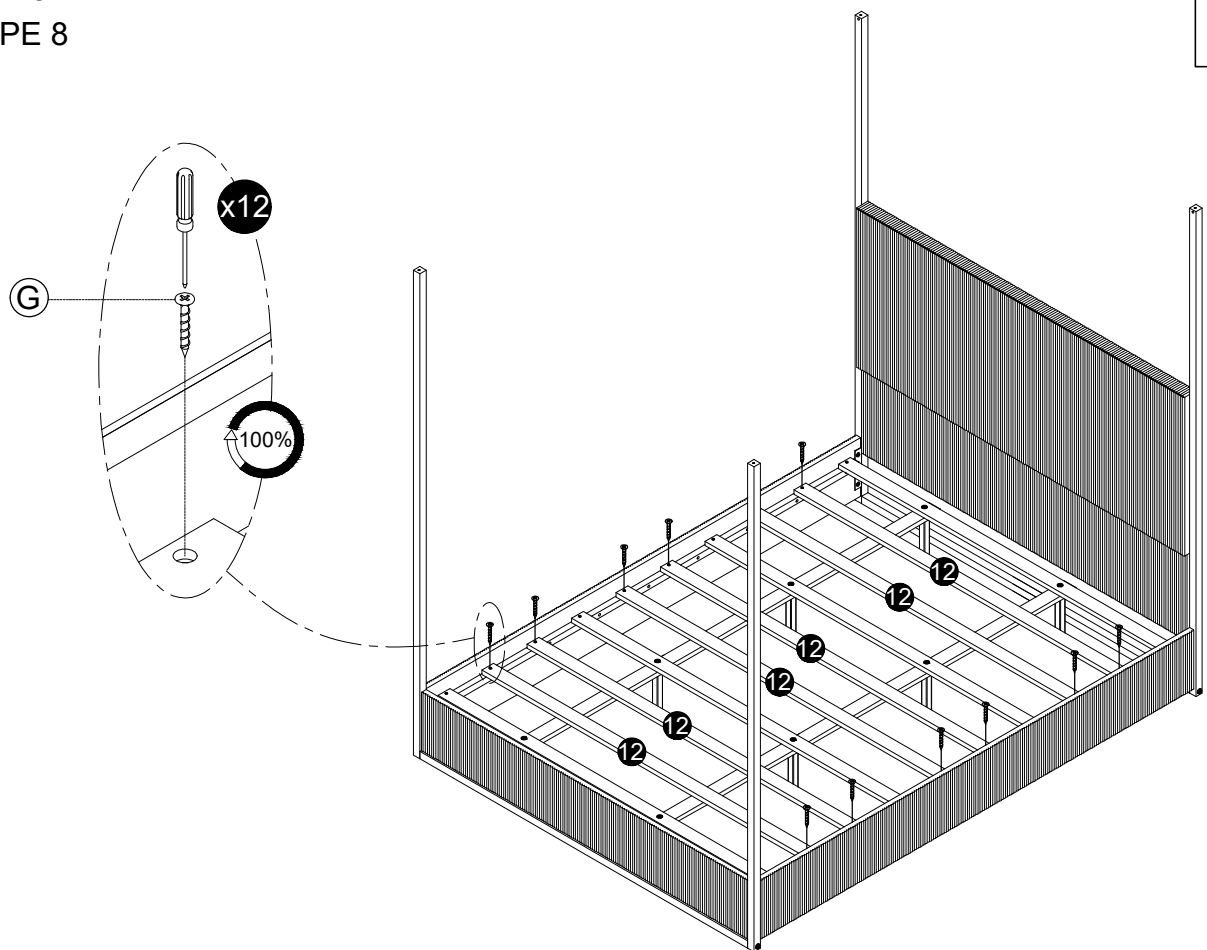

STEP 8
ÉTAPE 8

Gx12 



STEP 9
ÉTAPE 9

Ax8 	Dx8 	Ex8 	Fx1 
--	--	--	--

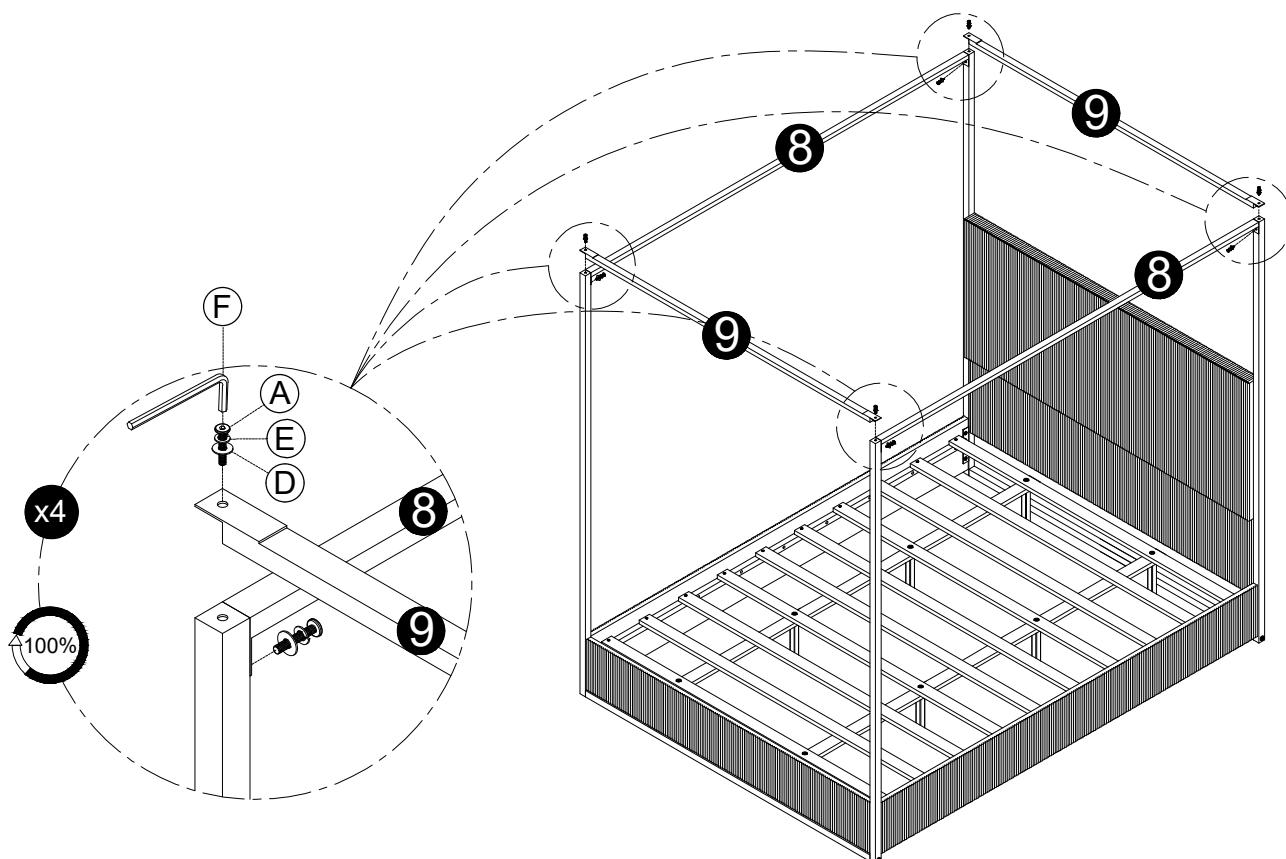

Finish
Finition

