

# Assembly Instructions

**Caution : You must read this before you proceed**

## **Chair**

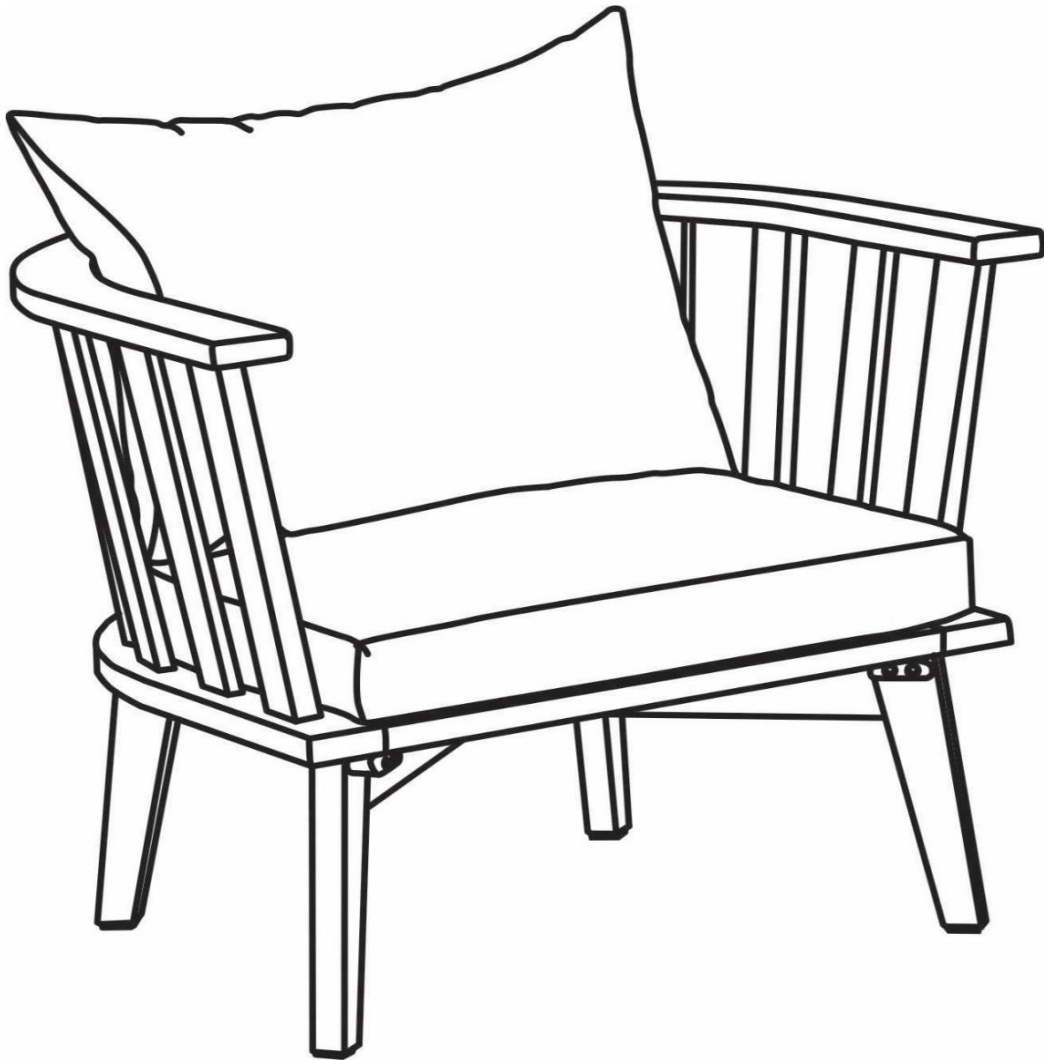



**CAUTION:** This Chair is NOT a TOY

Keep your child / children at bay in the process of assembly.

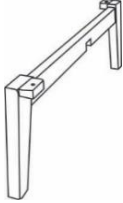
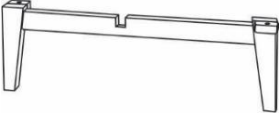
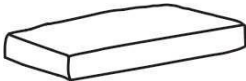

For turning the Chair and to prevent damage to the Chair, 02 persons may be needed to execute this action.

Whenever moving / lifting the Chair and to prevent damage to the Chair two adults are needed to execute these action.

# Parts List

Label	Picture	Description	QTY
A		Backrest Panel	1
B		Upper Leg Panel	1
C		Lower Leg Panel	1
D		Seat Cushion	1
E		Back Cushion	1

## Hardware

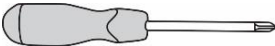
Label	Picture	Description	QTY
①		Bolt (M6x60mm)	5
②		Screw (M4x30mm)	5
③		Allen Key	2
④		Screw Driver (not provided)	1

## Assembly Preparation

### Before Beginning Assembly:

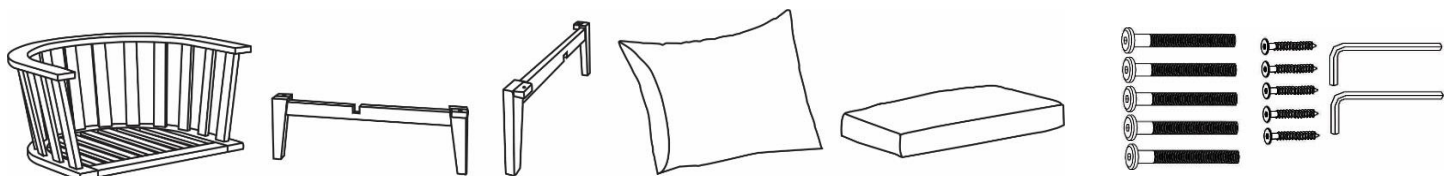

- Read instructions, cover to cover-



- Have 2 adults on hand for assembly-



- Do not assemble on flooring or carpet-



- Assemble on a clean non-marring surface (packing foam)-



- Save all packaging until finished-

# Assembly Steps

## Overview

Back Cushion (D)

Backrest Panel (A)

Seat Cushion (E)

Upper Leg Panel (B)

Lower Leg Panel (C)

**FRONT FACING**

This chair has multiple parts and may require up to 30 minutes to assemble. To give you an overview of the chair parts, the above picture is to help you put the various parts into perspective. Please read through the instructions below to familiarise yourself with the parts and steps before assembly.

## Step 1

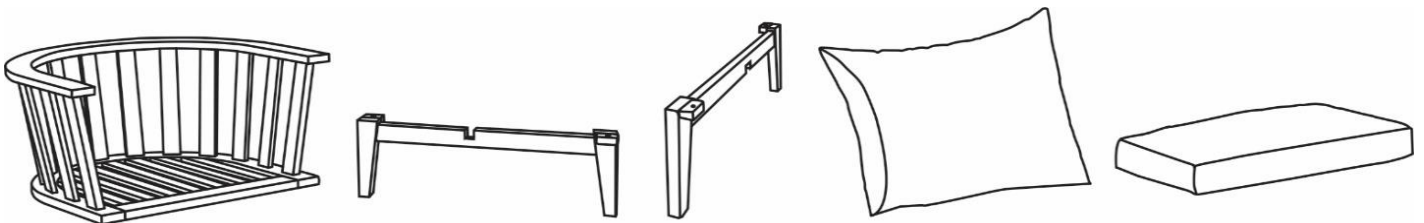

Unpack and place all parts on a clean, non-marring surface.

## Step 2

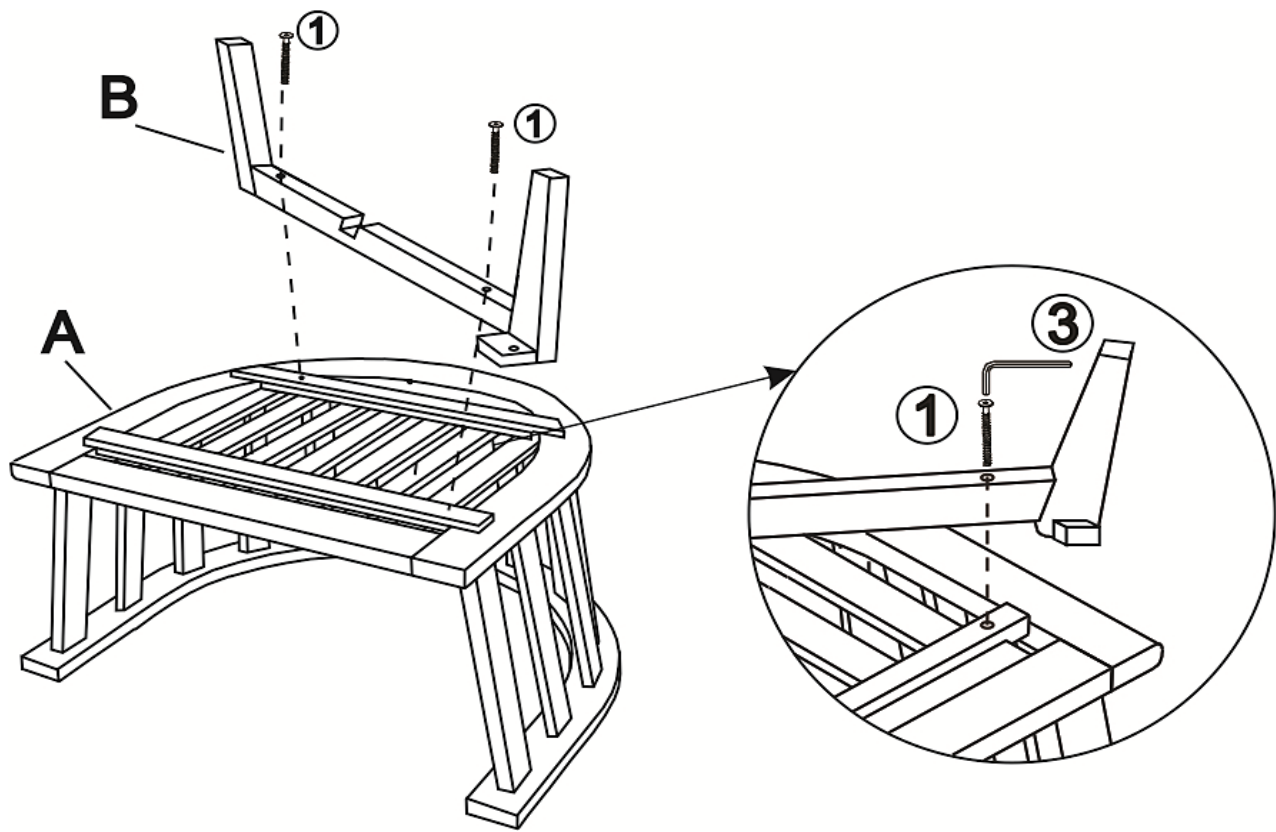

Place the Backrest Panel (A) facedown on a clean, non-marring surface. Attach Upper Leg Panel (B) to Backrest Panel (A) using Bolts (①) with Allen key (③) as shown above.

**Do not fully tighten the Bolts.**

**Caution: At the same time, please don't place your hands between the gaps to avoid injury.**

### Step 3

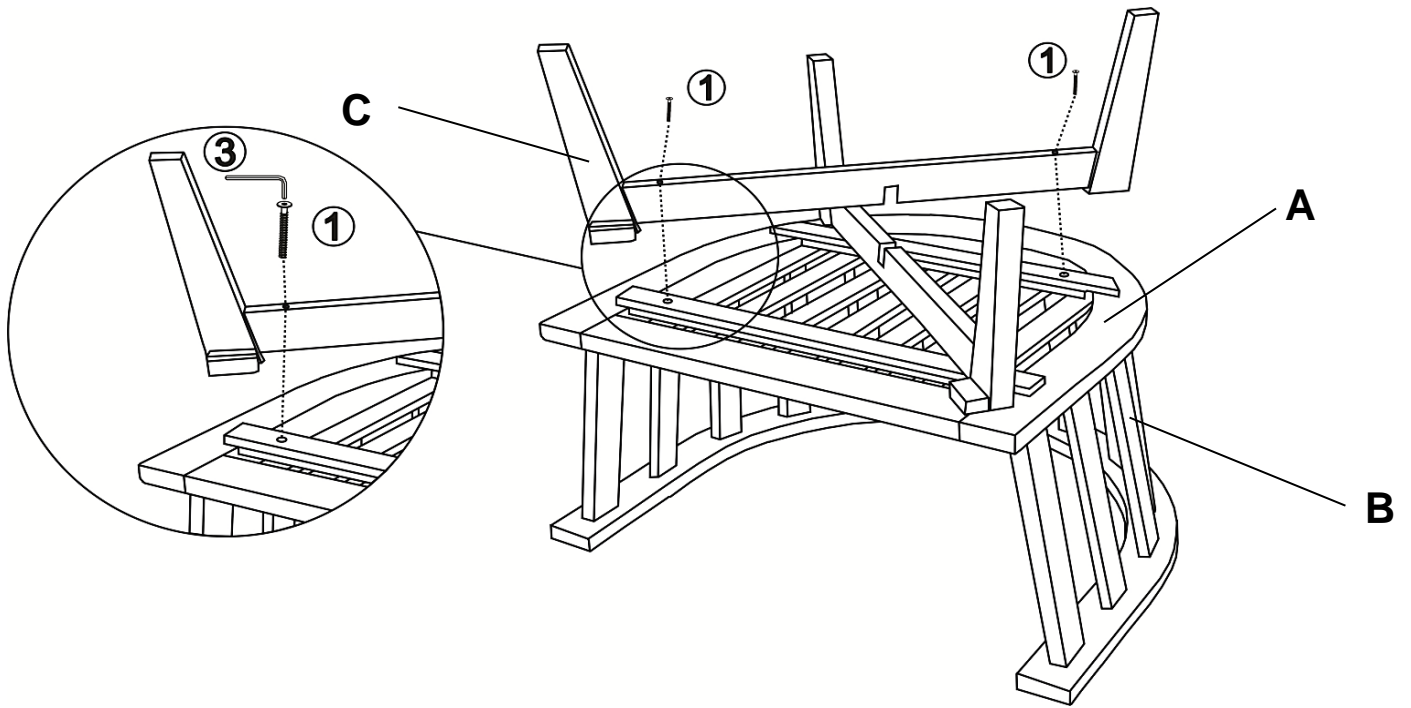

Insert Lower Leg Panel (C) to the pre-assembled in step 2 as pictured above. Attach Lower Leg Panel (C) to Backrest Panel (A) using Bolts (①) with Allen key (③).

**Do not fully tighten the Bolts.**

### Step 4

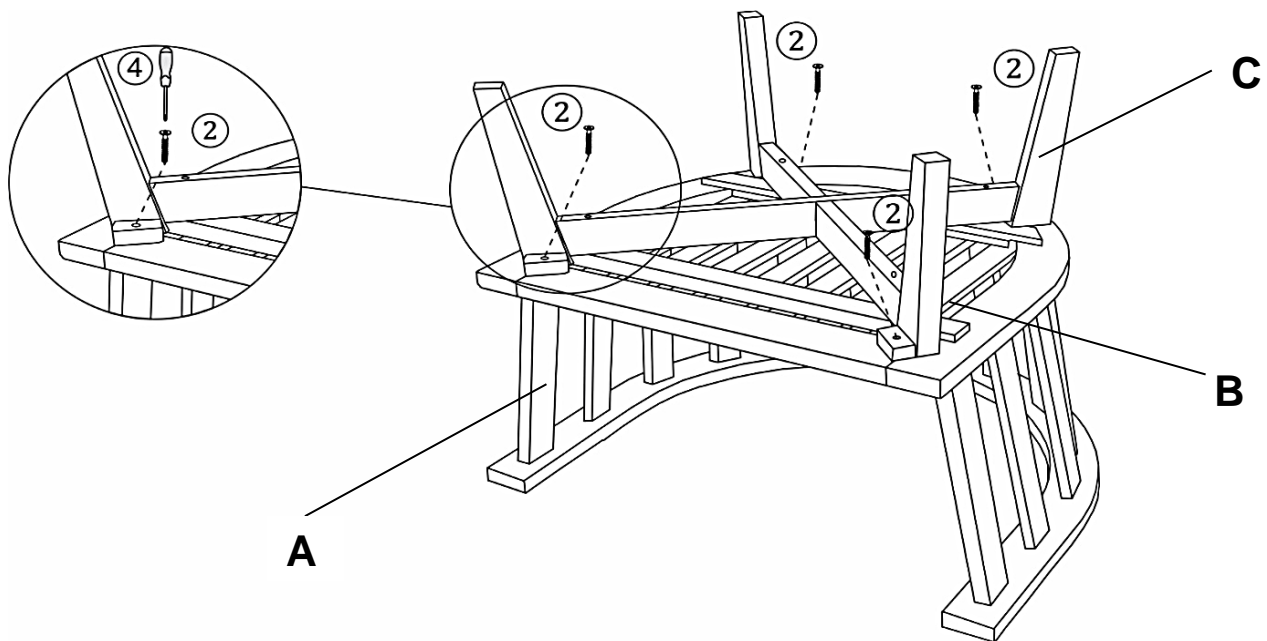

Attach Upper Leg Panel (B) and Lower Leg Panel (C) to Backrest Panel (A) using Screws (②) with Allen key (③) as shown above.

**Do not fully tighten the Screws.**

## Step 5

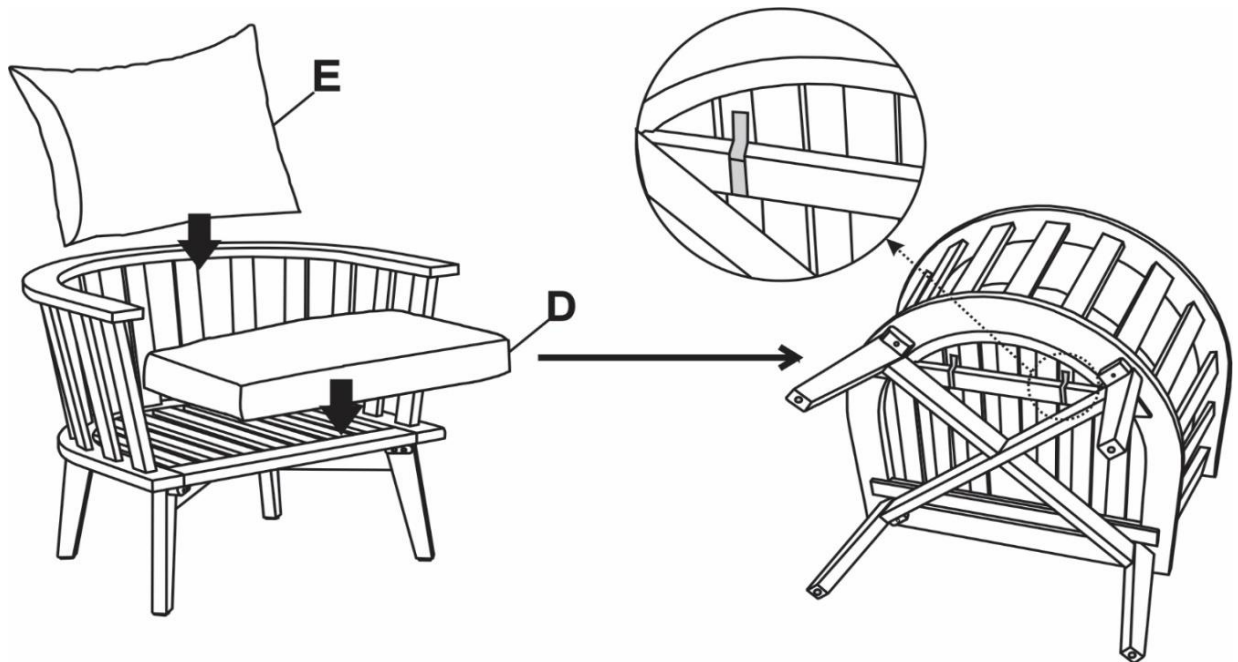

Place the Chair on a **LEVEL SURFACE**.

Inspect it and make sure all parts are adequately connected.

Gently and gracefully, sit into to the Chair.

This will help to align all the parts at all joint areas.

Then get off the Chair and proceed to tighten the Bolts and Screws in a sequential manner.

**When tightening the Bolts and Screws tighten sequentially.**

**DO NOT** tighten any Bolt or Screw fully and then move on towards the next one.

If there are still wobbles, loosen the Bolts and Screws and execute this same process.

Place the Seat Cushion (D) and Back Cushion (E) into the Chair.

Attach the velcro of Seat Cushion (D) to the Chair as shown above.



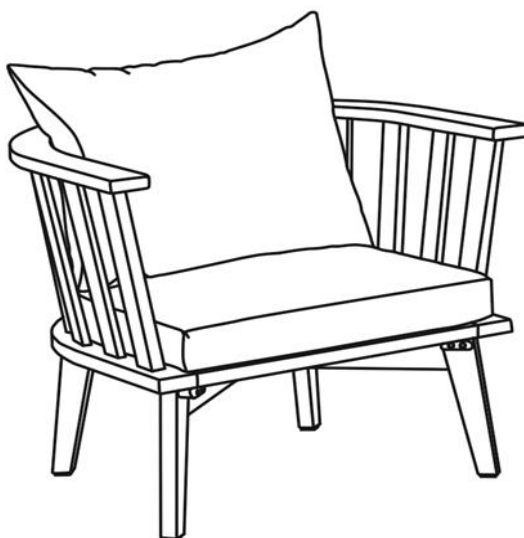







## Step 6



Your Chair is ready for use.

**This Chair can only be used on a flat , level surface.**

## Care & Maintenance

-  ● Do not put hot items directly on furniture surface
  -  ● Do not clean furniture with harsh cleansers or polish.
  -  ● To obtain the longest lifespan of your outdoor products, minimizing exposure to direct sunlight is recommended.
  -  ● Children should not climb or jump on the furniture.
  -  ● Do not write on furniture without a padded barrier to protect the surface.
  -  ● To obtain the longest lifespan of your outdoor products, avoid extended and lengthy exposure to rain, snow, and direct sunshine. Whenever possible cover the product and /or place under patio or awnings.
  -  ● Not for commercial use. For residential use only .
  -  ● Stains may be removed with mild soap solution and damp cloth.
  -  ● Keep away from sources of ignition.
- 
-  ● Dust and pick-up spills using a clean, non-colored, lint-free cloth.