





















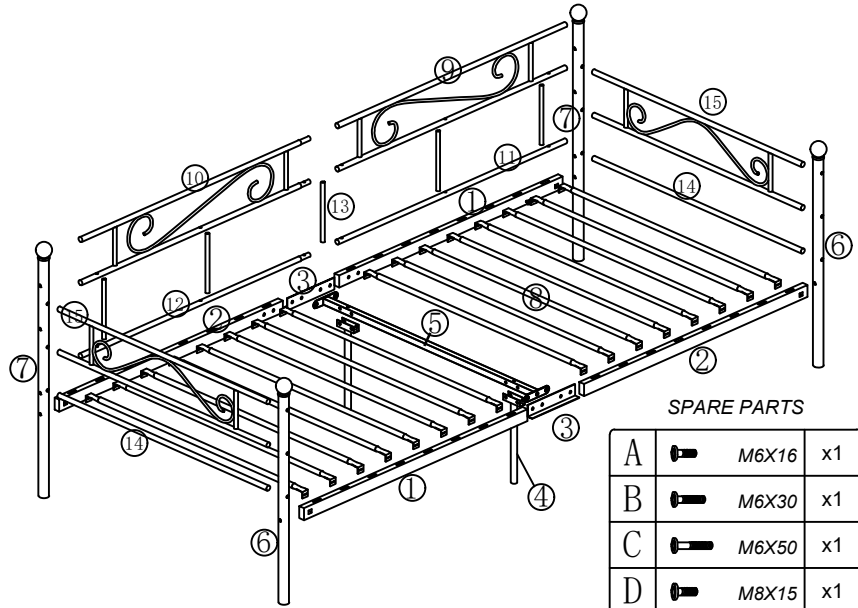



## **WARNING**





·Please don't fasten all screws until you assemble full bed.

A		M6X16	x4
B		M6X30	x10
C		M6X50	x18
D		M8X15	x8
E			x4
F		M8X35	x2
G		M8X70	x4
H			x22
I			x2
J		M6X18	x4
K			x32
L		M4	x2
M		M5	x1

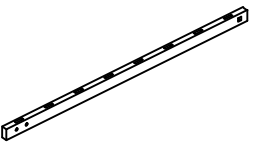
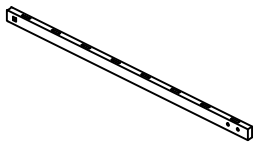
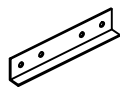

SPARE PARTS

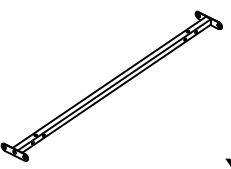
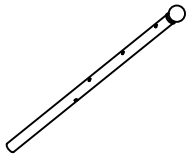
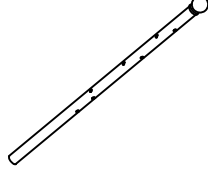
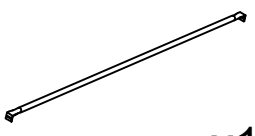
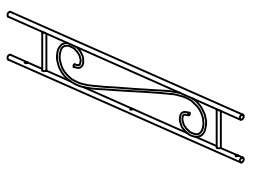
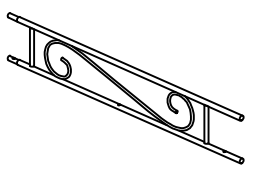
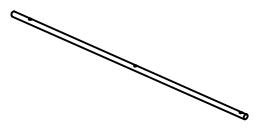
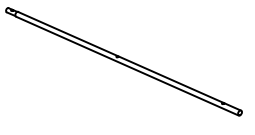
A		M6X16	x1
B		M6X30	x1
C		M6X50	x1
D		M8X15	x1
E			x1
F		M8X35	x1
G		M8X70	x1
H			x1
I			x1
J		M6X18	x1
K			x1

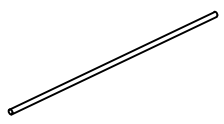
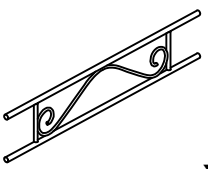
1  x2	2  x2	3  x2	4  x2
5  x1	6  x2	7  x2	8  x16
9  x1	10  x1	11  x1	12  x1
13  x5	14  x2	15  x2	

# STEP 1

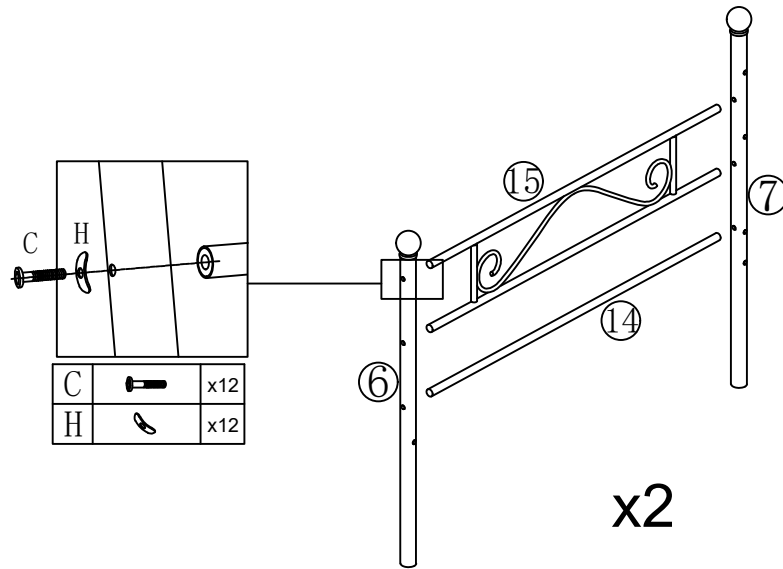

# STEP 2

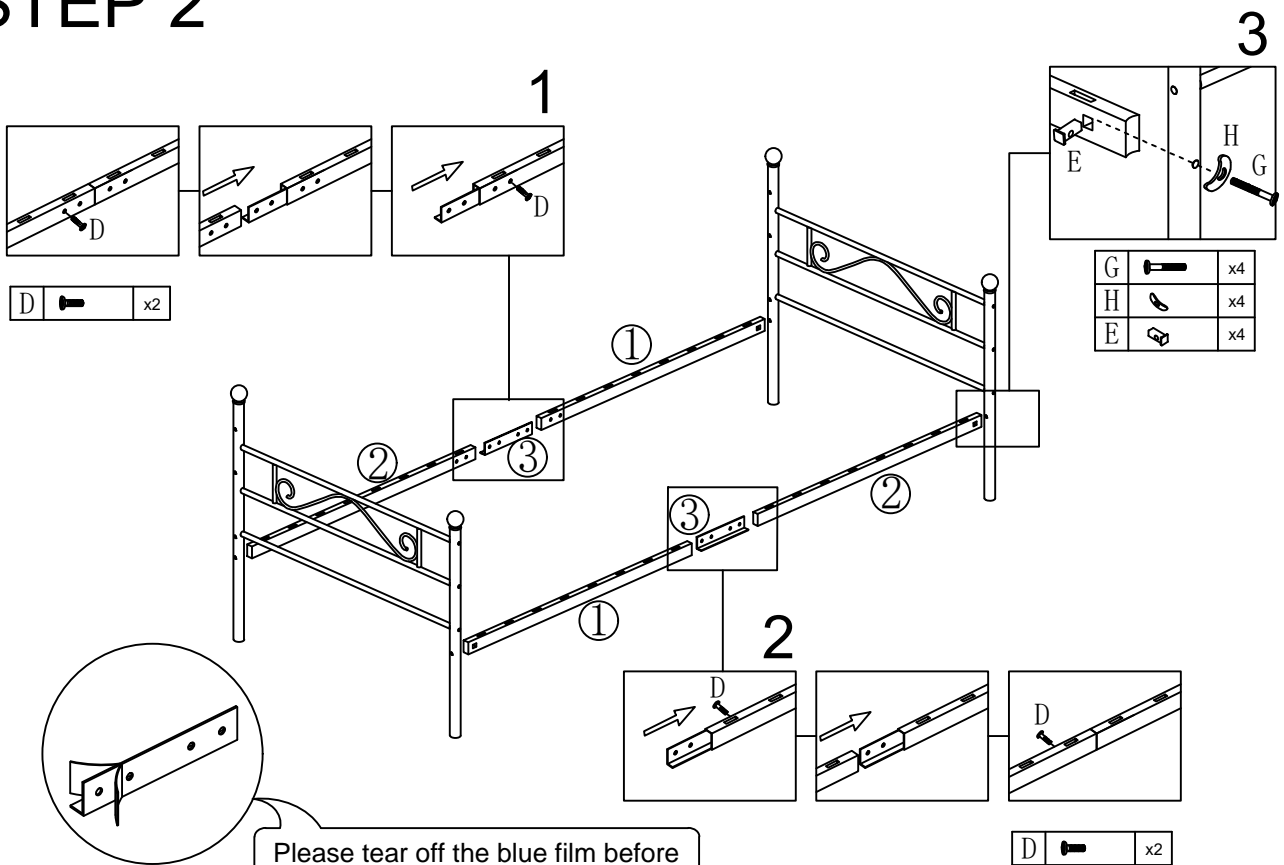

# STEP 3

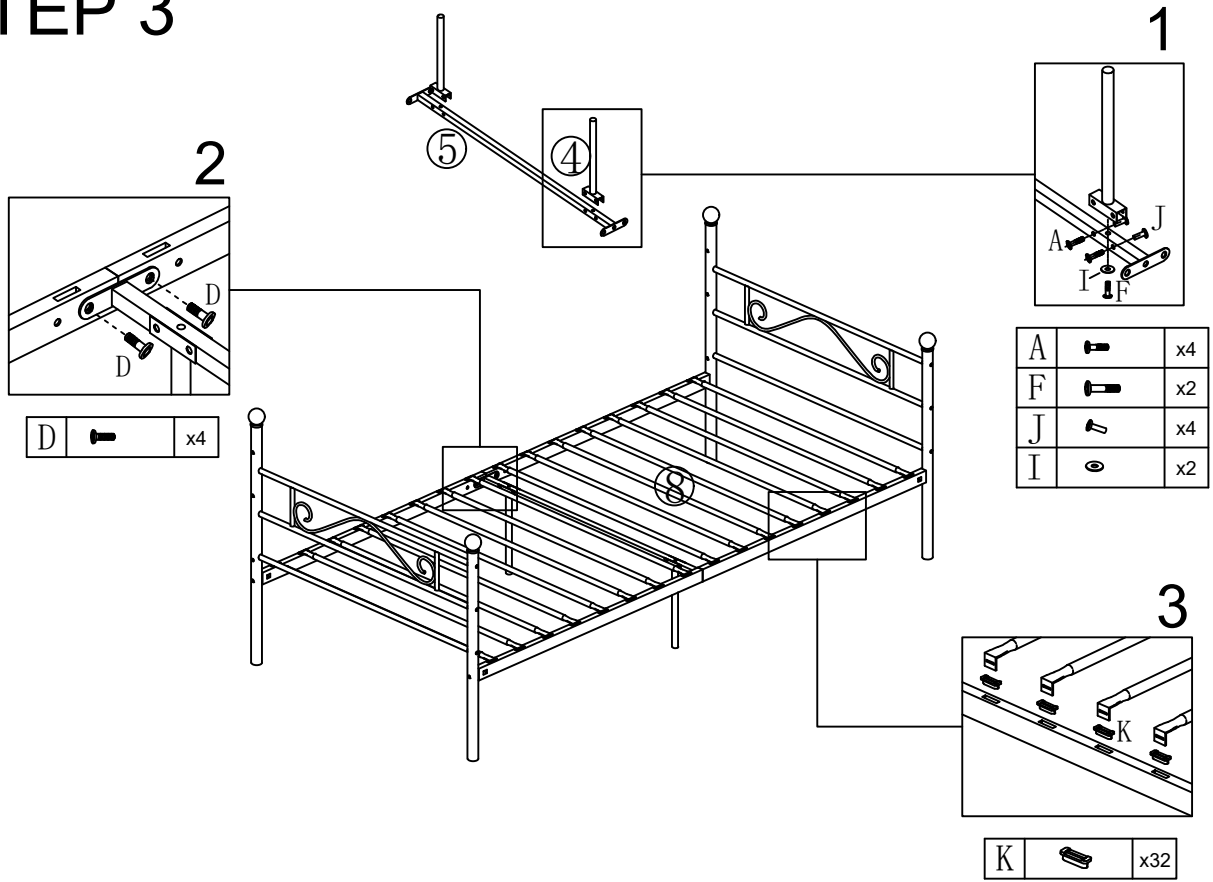

# STEP 4

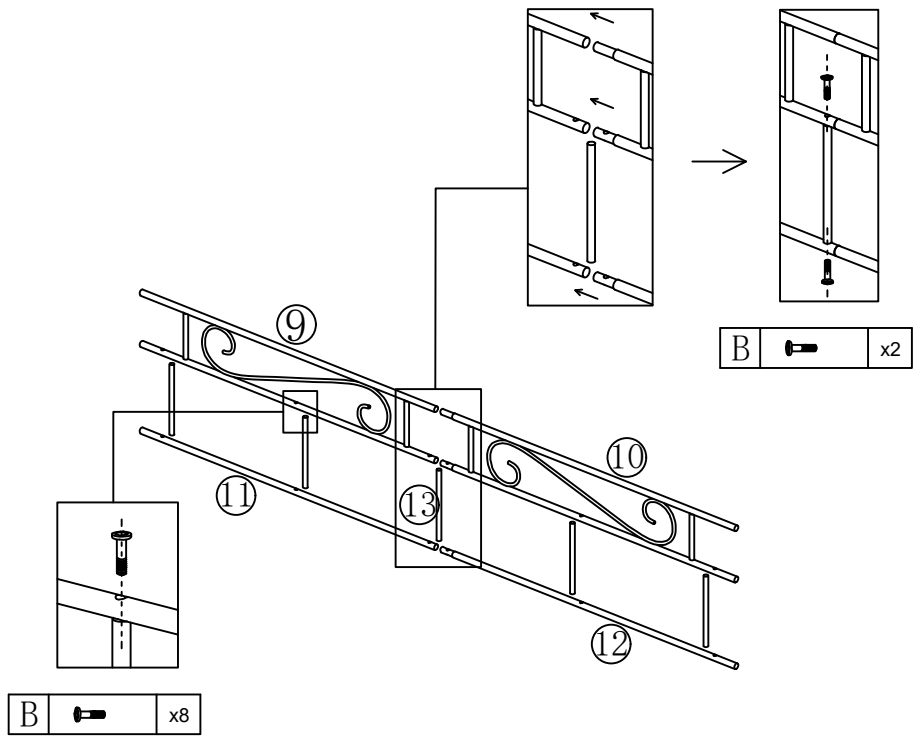

# STEP 5

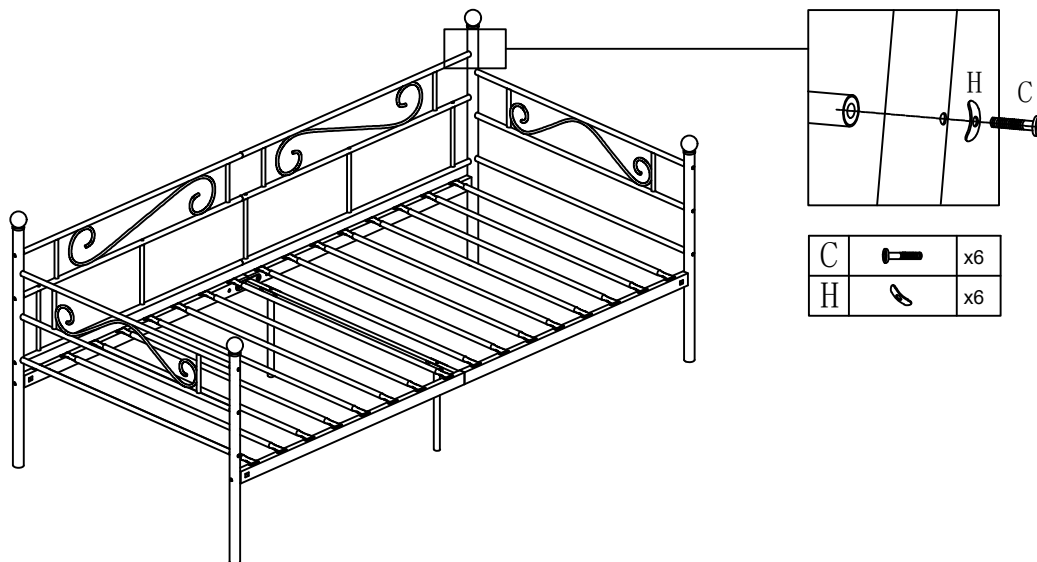

# STEP 6

