

YZZW-V1

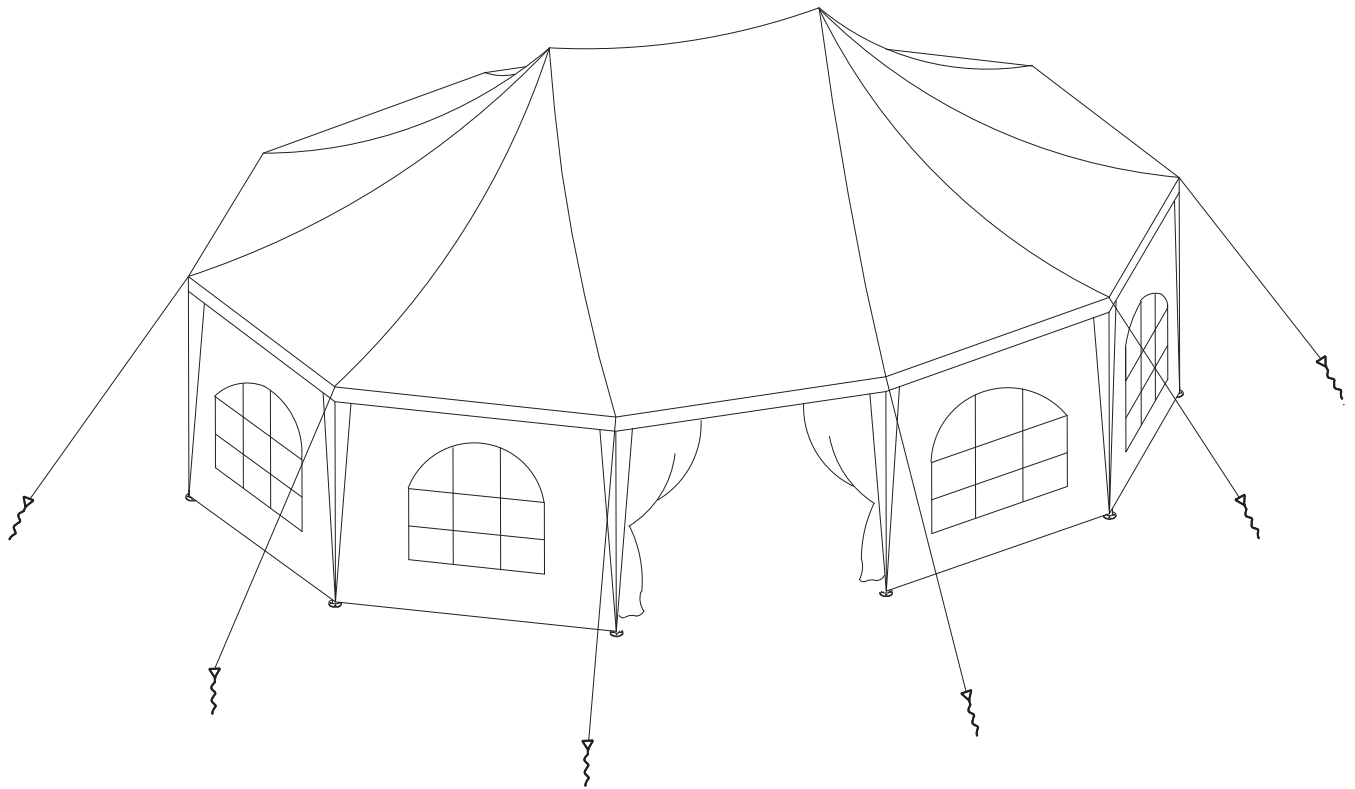

WEDDING TENT



1. Three or more people are required for the assembly.
2. A ladder is recommended during assembly.
3. Ensure you have all the required parts and organize them before assembling.
4. An electric drill is recommended for the assembly.
5. Do not use candles, matches or open flames of any kind inside or near a tent.
6. Professional installation is highly recommended.

Item no.	Reference Image	Qty.
1		X11
2		X10
3		X10
4		X10
5		X2
6		X2
A		X2
B		X2
C		X6
D		X10
E	M6 X 45MM	X10

Item no.	Reference Image	Qty.
F		X2
G		X10
H		X20
I		X10
J		X48
K		X1
L		X2
M		X2

1

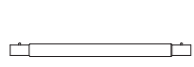

① 10pcs



Ⓐ 2pcs



Ⓑ 2pcs



Ⓒ 6pcs

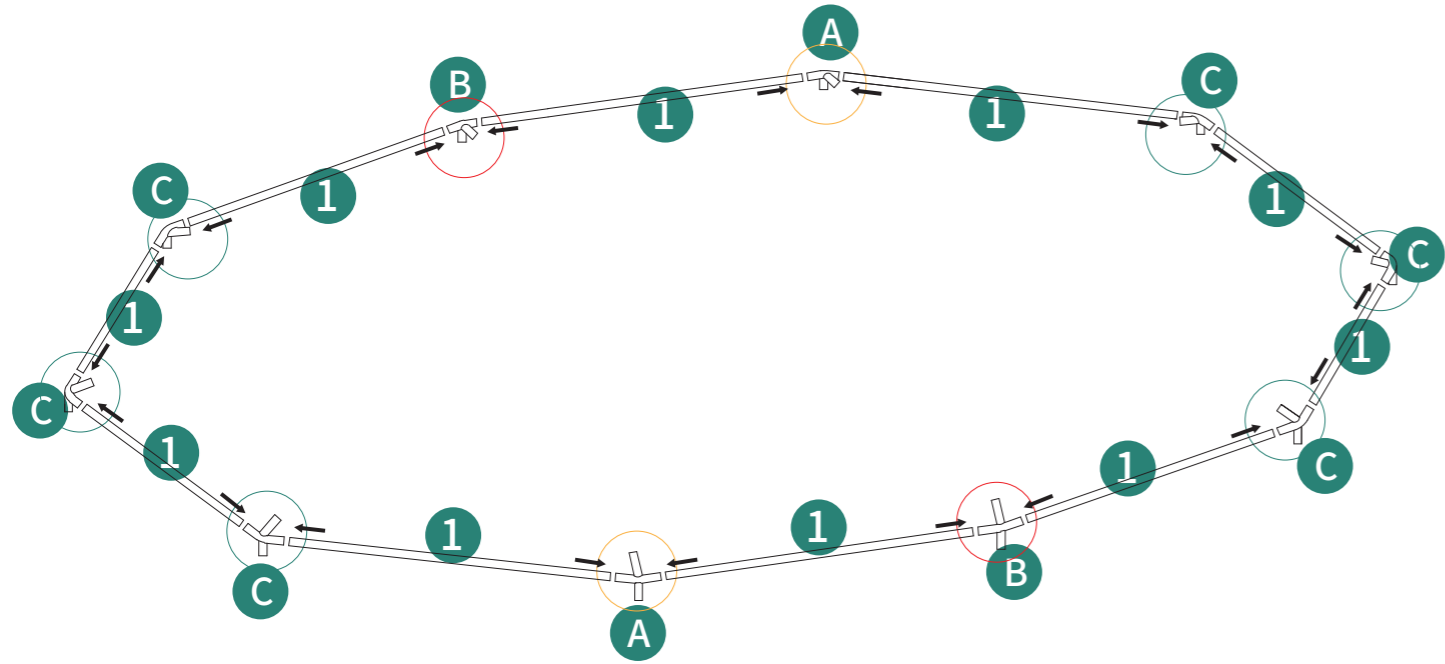

2

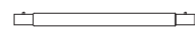

① 1pc

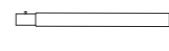

③ 10pcs

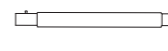

④ 10pcs

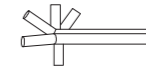

⑤ 2pcs

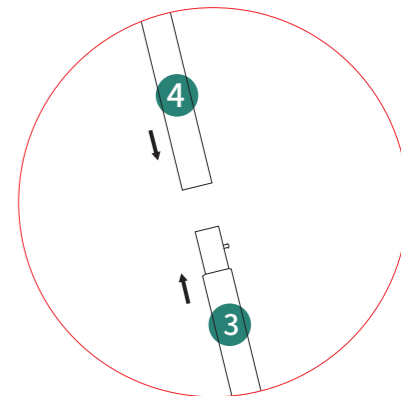
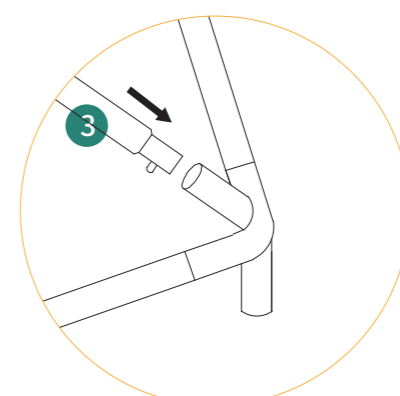
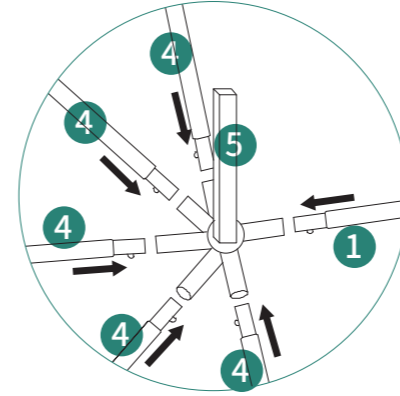
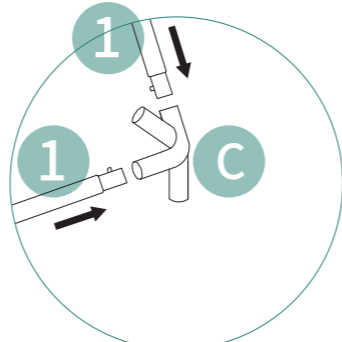
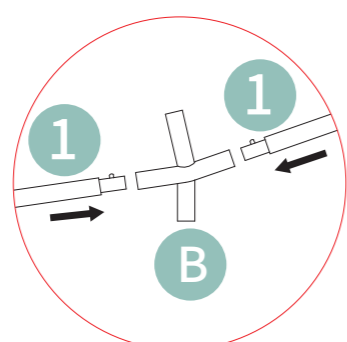
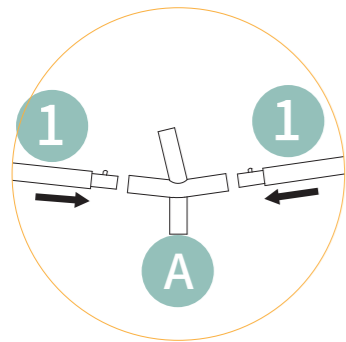
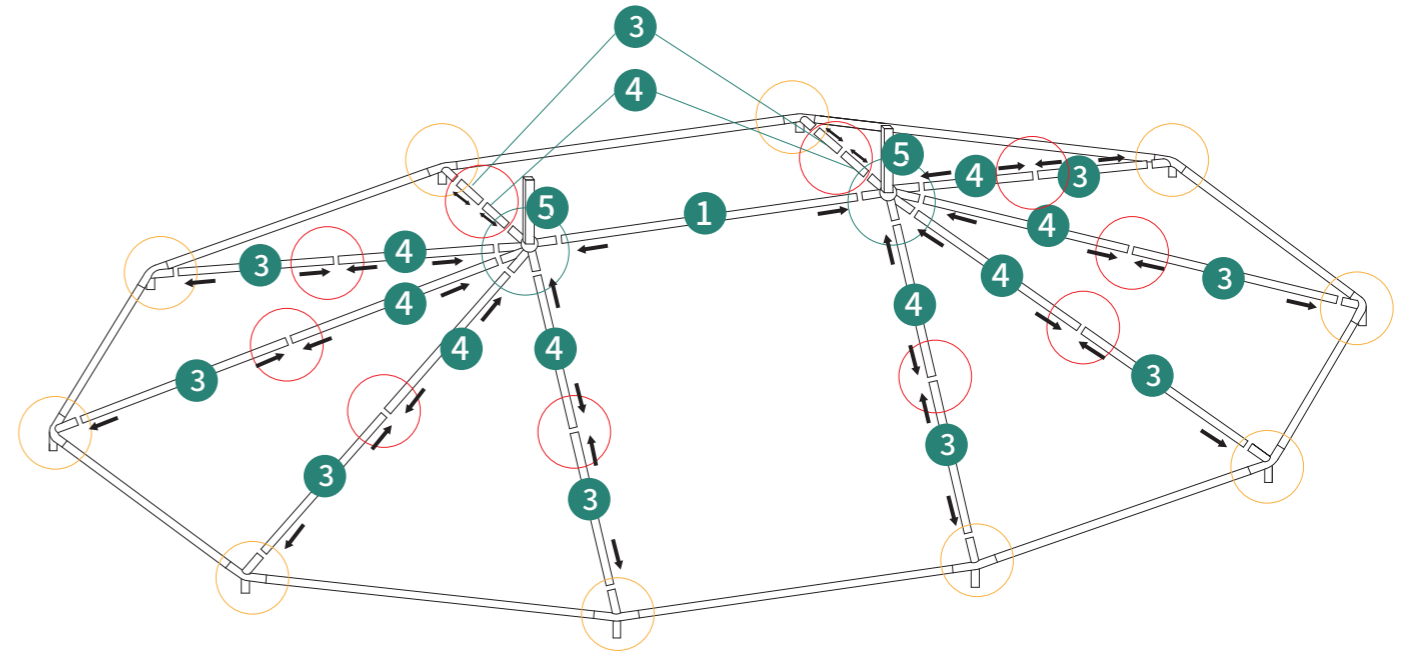

3

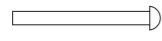

ⓐ 2pcs



ⓕ 2pcs

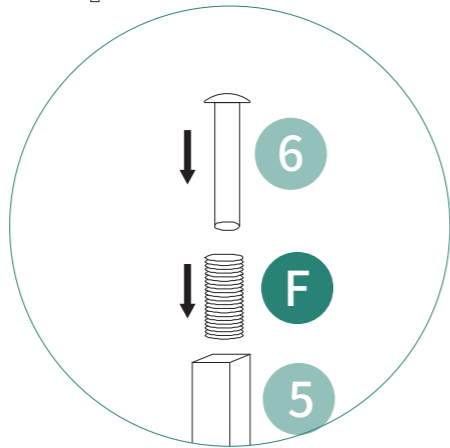
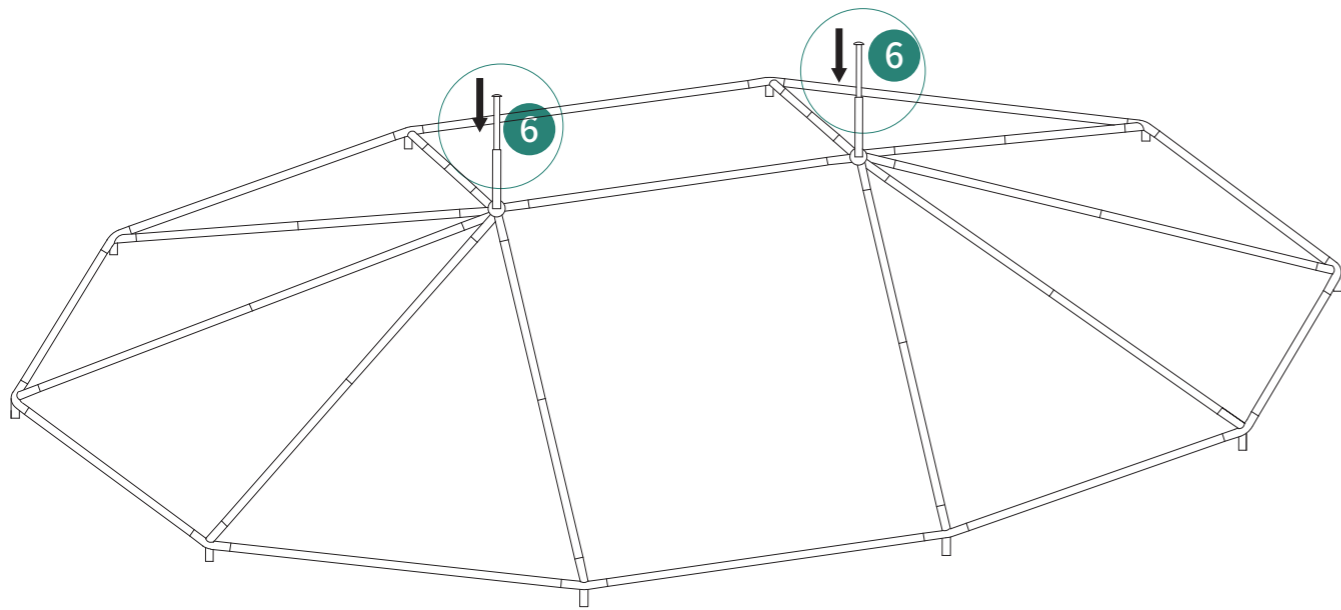

5

4

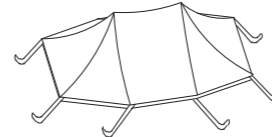

Ⓚ 1pc

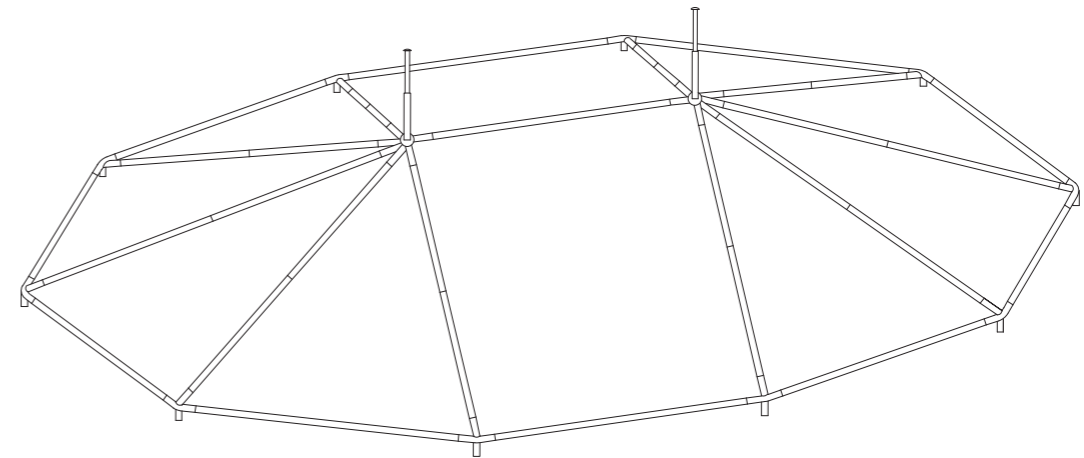
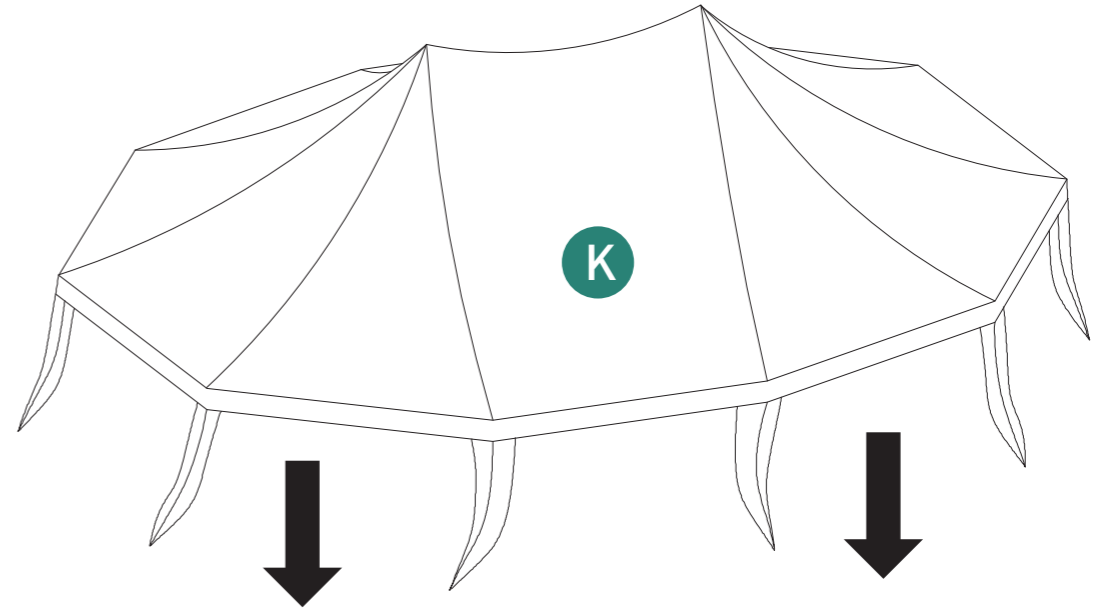

6

5



② 10pcs



④ 10pcs



⑤ 10pcs



⑥ 48pcs

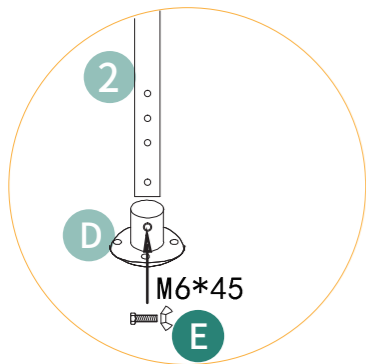
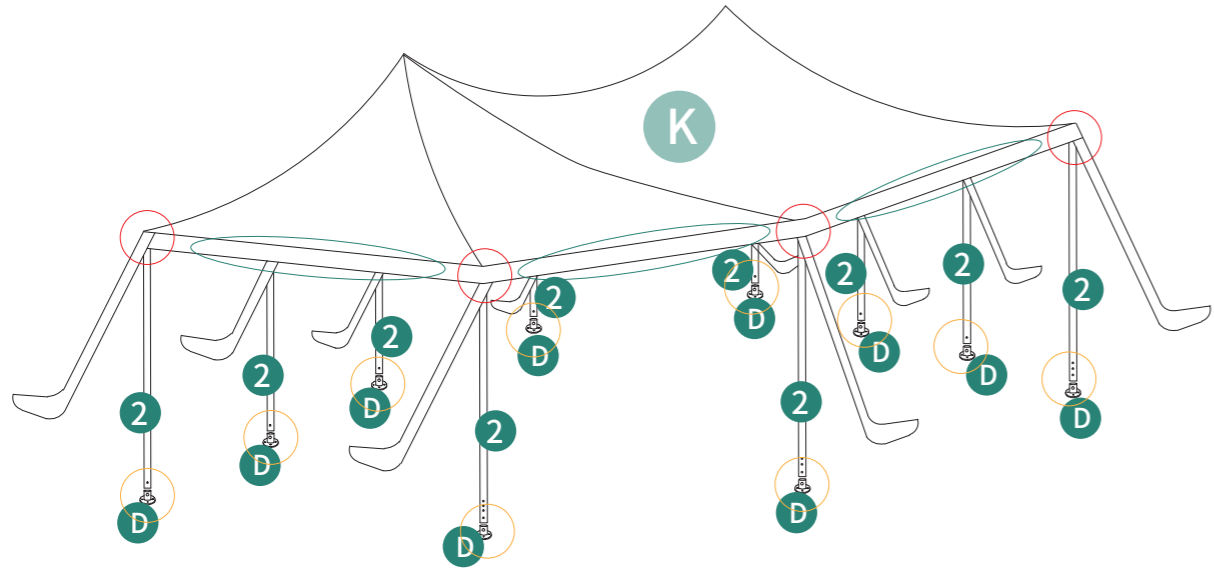

1

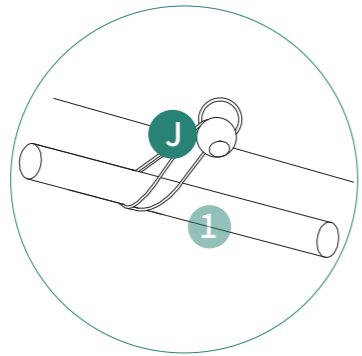

2

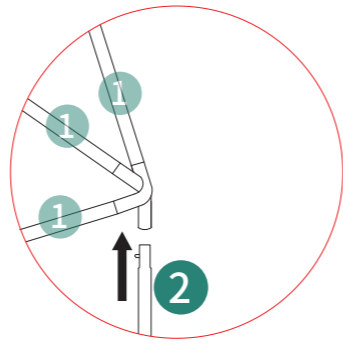

3

7

6



⑧ 20pcs

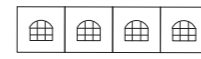

⑨ 2pcs

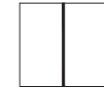

⑩ 2pcs

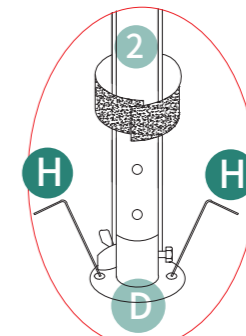
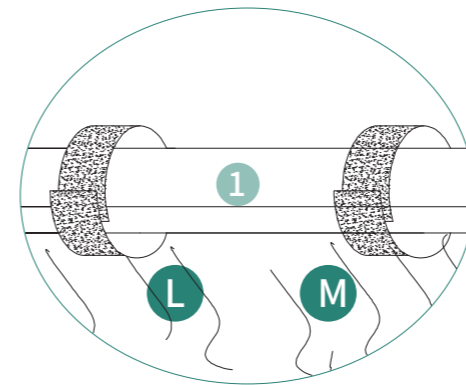
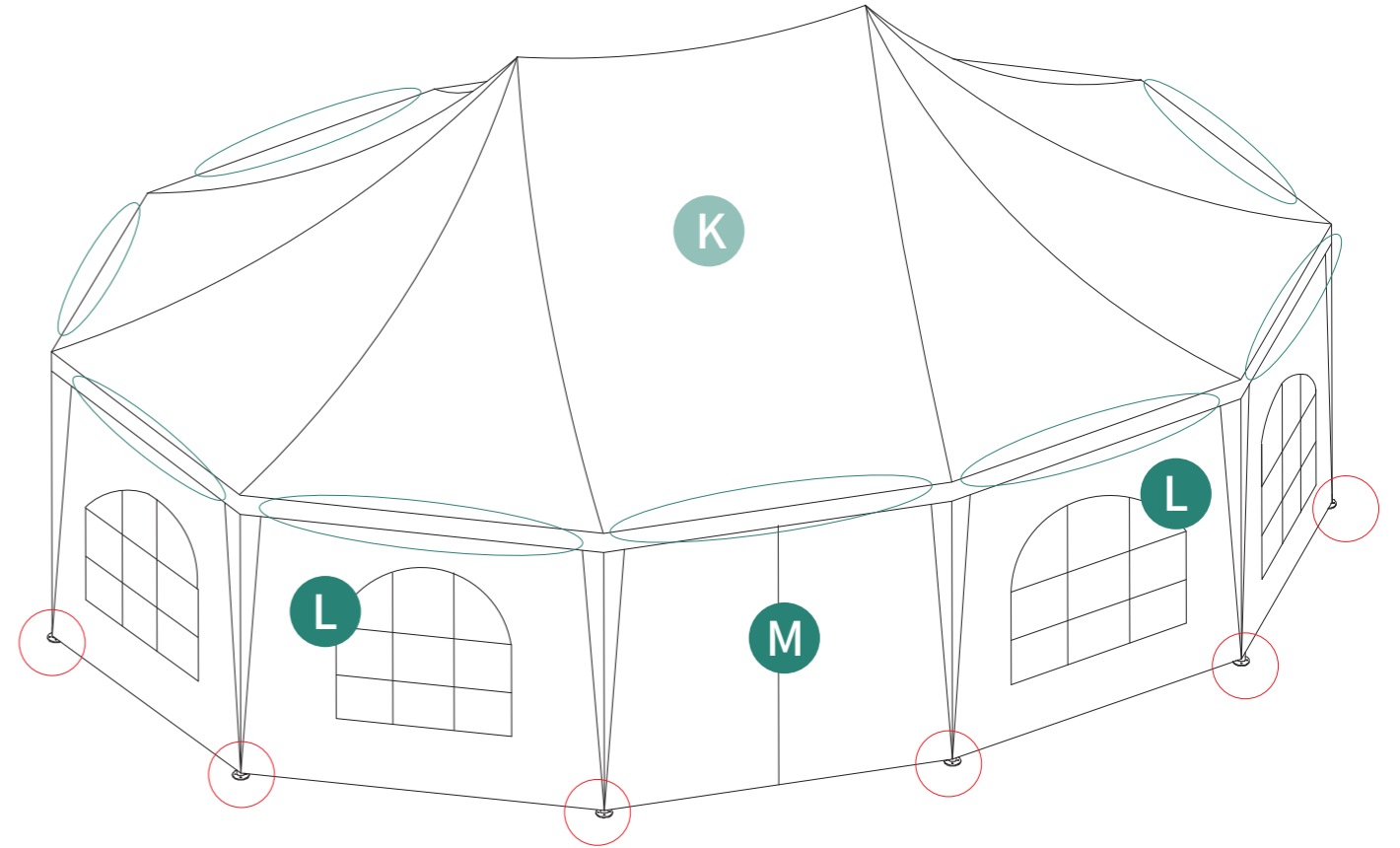

1

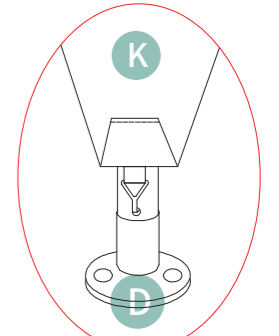

2

8

7

ⓐ10pcs ⓘ10pcs

8

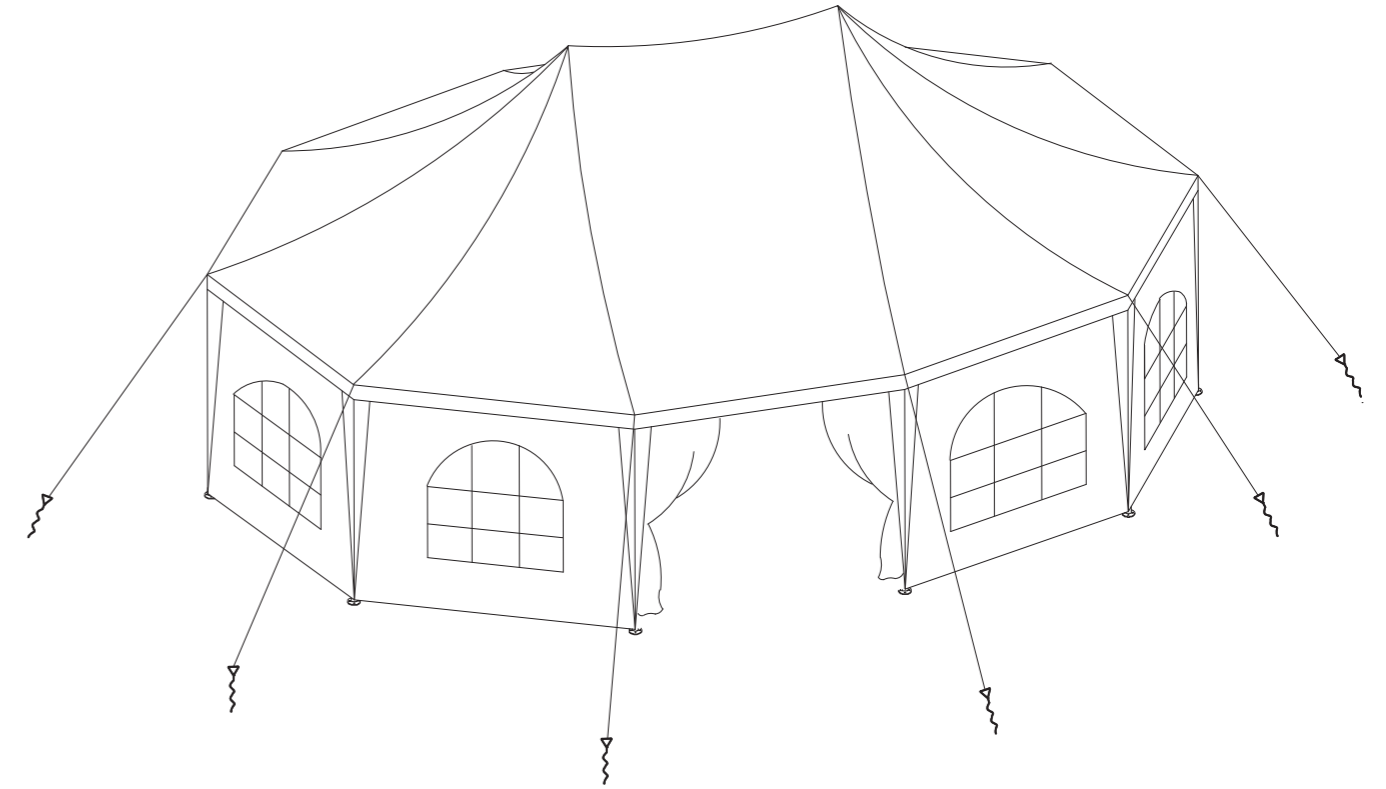
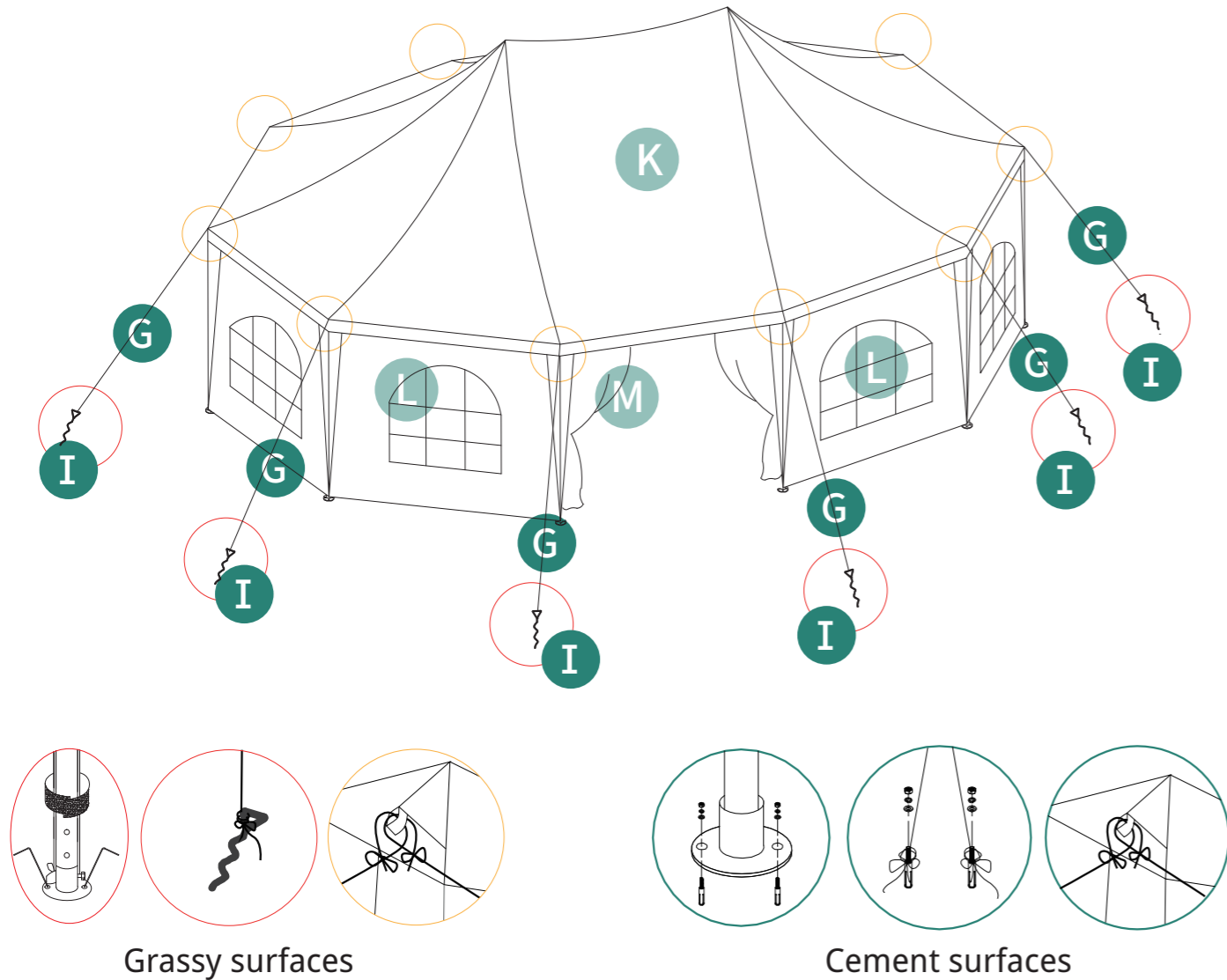

To improve wind resistance,
be sure to complete this installation step. If expansion screws or ground nails are not installed, strong winds may topple the gazebo.
 Expansion screws are essential for stability on cement surfaces, and ground nails are for grassy surfaces.
 Ground nails are included in the package while expansion screws are not provided.

Installation Completed