

ASSEMBLY INSTRUCTIONS



TOOLS REQUIRED:

Allen Wrench (Provided, Part D)
Phillips Screw Driver (Not Provided)

BEFORE YOU START:

1. Check the hardware against the hardware list to make sure all items are present.
2. Assemble your furniture on a soft, flat surface to avoid scratching the finish.
3. **CAUTION:** Do not over tighten screws, nuts or bolts during assembly.
4. Your furniture may require occasional tightening.

INSTRUCTIONS:

1. Turn the table Top upside down on a clean soft surface.
2. Assemble the legs to the top using Bolt (A), Lock Washer (B), Flat Washer (C) and Allen Wrench (D).
DO NOT FULLY TIGHTEN! As shown in Figure 1 .
3. Assemble bottom frame to the legs using Bolt (A), Lock Washer(B), Flat Washer (C) and tighten all bolts using Allen Wrench (D), as shown in Figure 2 .
4. Tighten all bolts before using the table.

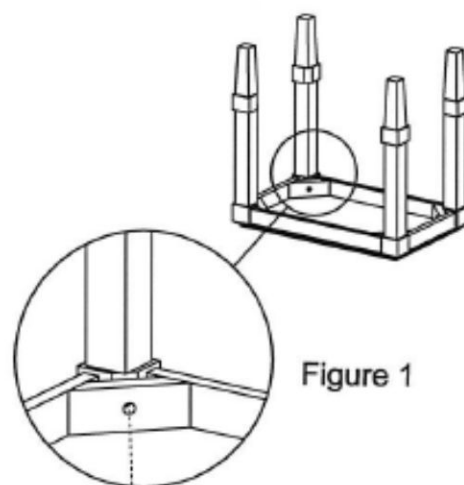

Figure 1

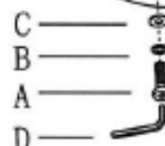
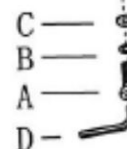
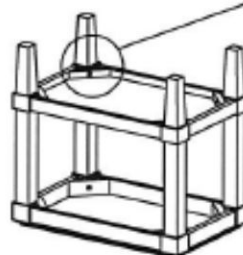





Figure 2



| HARDWARE LIST | | | |
|---------------|---|--------------------|------|
| A |  | 5/16"x1-3/4" Bolt | 8pcs |
| B |  | 5/16" Lock Washer | 8pcs |
| C |  | 5/16" Flat Washer | 8pcs |
| D |  | 5/16" Allen Wrench | 1pc |

Thank you for purchasing furniture
from Hammary!