







END TABLE ASSEMBLY INSTRUCTION

PARTS LIST Before you begin , please layout all parts and ensure you have the correct count .

#	DESCRIPTION	QTY	ILLUSTRATION
A	TABLE TOP	1	
B	TABLE BASE	1	
C	ALLEN KEY (4MM)	1	
D	ALLEN BOLT (M8x30)	3	
E	LOCK WASHER (M8)	3	
F	FLAT WASHER (M8)	3	

ASSEMBLY INSTRUCTIONS

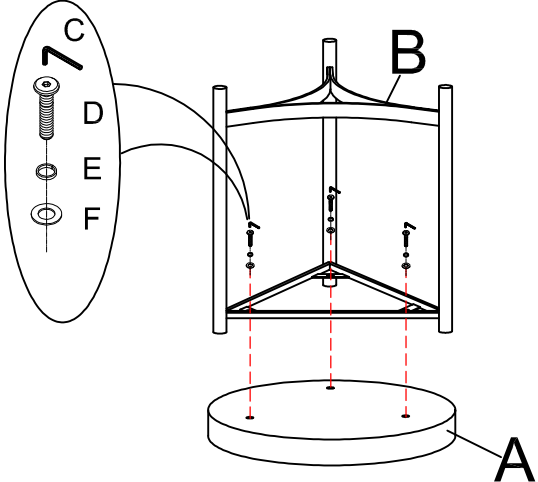
STEP	INSTRUCTIONS	ILLUSTRATION
1	<p>ON A FLAT, LEVEL AREA LAY DOWN A CLEAN BLANKET OR TOWEL. PLACE THE TABLE TOP (A) TOPSIDE DOWN. ATTACH THE TABLE BASE (B) TO THE TOP WITH THREE ALLEN BOLTS (D), LOCK WASHERS (E) AND FLAT WASHERS (F). TIGHTEN WITH PROVIDED ALLEN KEY (C).</p> <p>NOTE! DO NOT OVERTIGHTEN THE BOLTS OR YOU CAN RISK DAMAGING THE TABLE.</p>	
2	<p>WITH THE HELP OF A SECOND PERSON, FLIP THE ASSEMBLED TABLE RIGHT SIDE UP.</p> <p>YOUR TABLE IS NOW COMPLETE AND READY FOR USE.</p>	