

Dimension/Specification

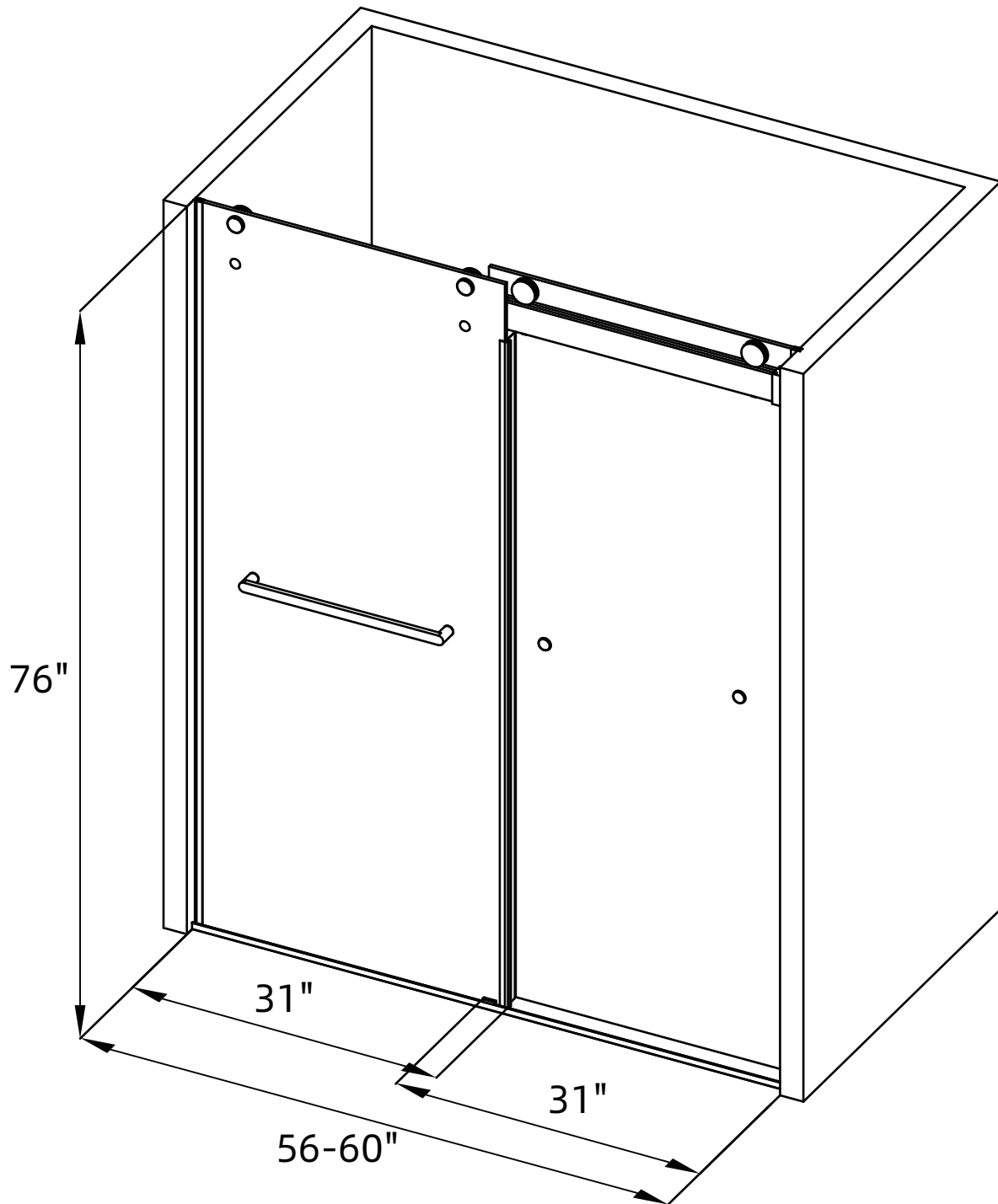

RX-SD02-6076BN