

15 : 00

estimated
assembly time



2 or more

people required

Ok, let's
get started!



- Put on mood music!
- To prevent damage to product, use the clean side of package carton or rug as working surface.
- In the event of missing or damaged parts, delivery problems etc., please reach out to our team.
We will be happy to fix the problem!

care guide

- Clean regularly with a soft and dry cloth.
- To protect finish, avoid use of abrasive cleaners.
- Wipe up spills immediately. Please!

ⓘ **While assembling the product, tighten the bolts up to 50%. Once all parts are in place, only then fully tighten the bolts.**



product parts

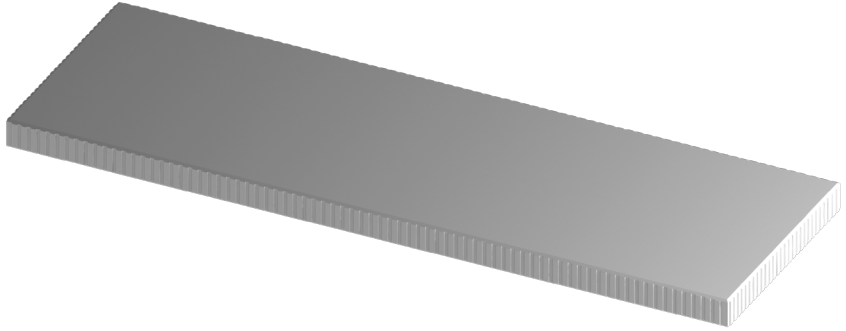

A
Tabletop
x1

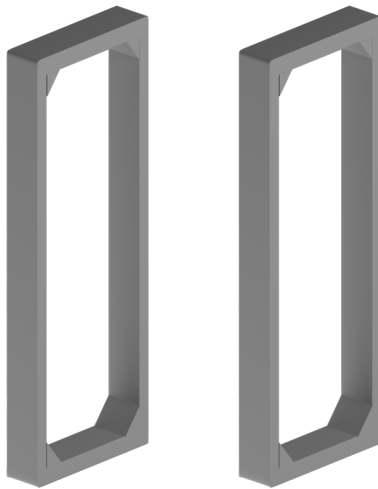

B
Table Legs
x2

what's included



(C) - Bolt
(8 x 35mm)
x4

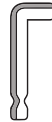

(D) - Allen Key
x1



(E) - Flat Washer
(8 x 20mm)
x4



(F) - Lock Washer
(8 x 16mm)
x4

assembly instructions

Friendly Tip: Take a deep breath going in. This may be a tricky part, but nothing too overwhelming. Just follow these steps to the T and the outcome will be worth it!



- ⓘ While assembling the product, tighten the bolts up to 50%. Once all parts are in place, only then fully tighten the bolts.

step 1:

Start by placing the tabletop (A) upside down. Align the table legs (B) with the slots on the tabletop. Take this image as reference.

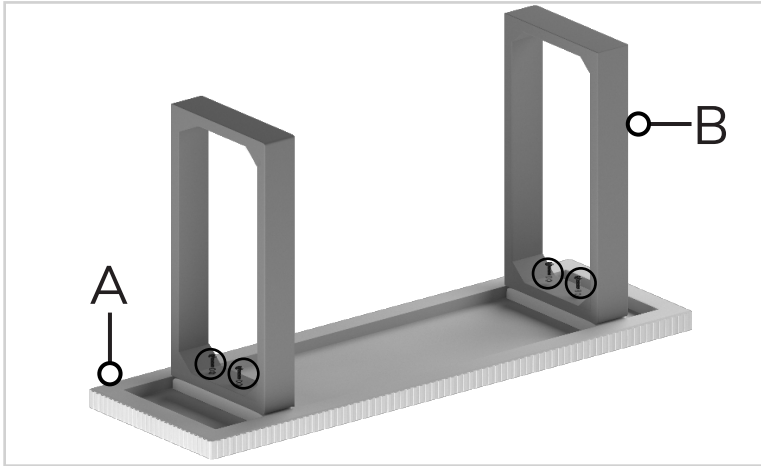

step 2:

Now, secure the table legs in place by using flat washer (E), lock washer (F), and bolt (C) in the given slots. Tighten all points with allen-key (D). If required, adjust the leveller according to the floor.

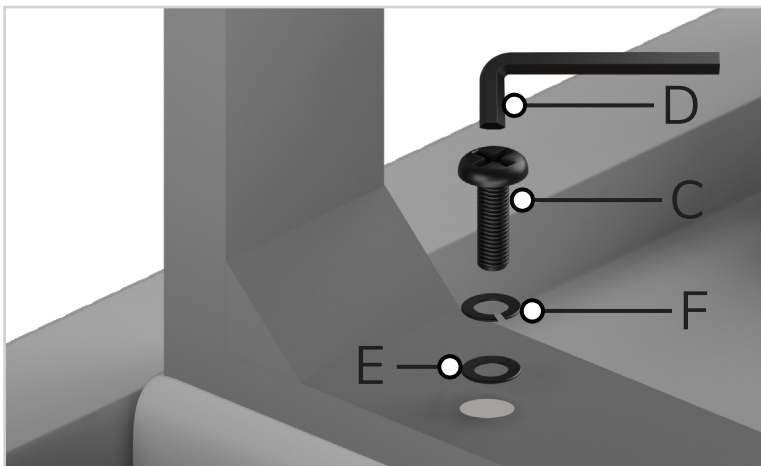

Voila! Your table is now assembled and secure!

you've
got
a home
with us

