

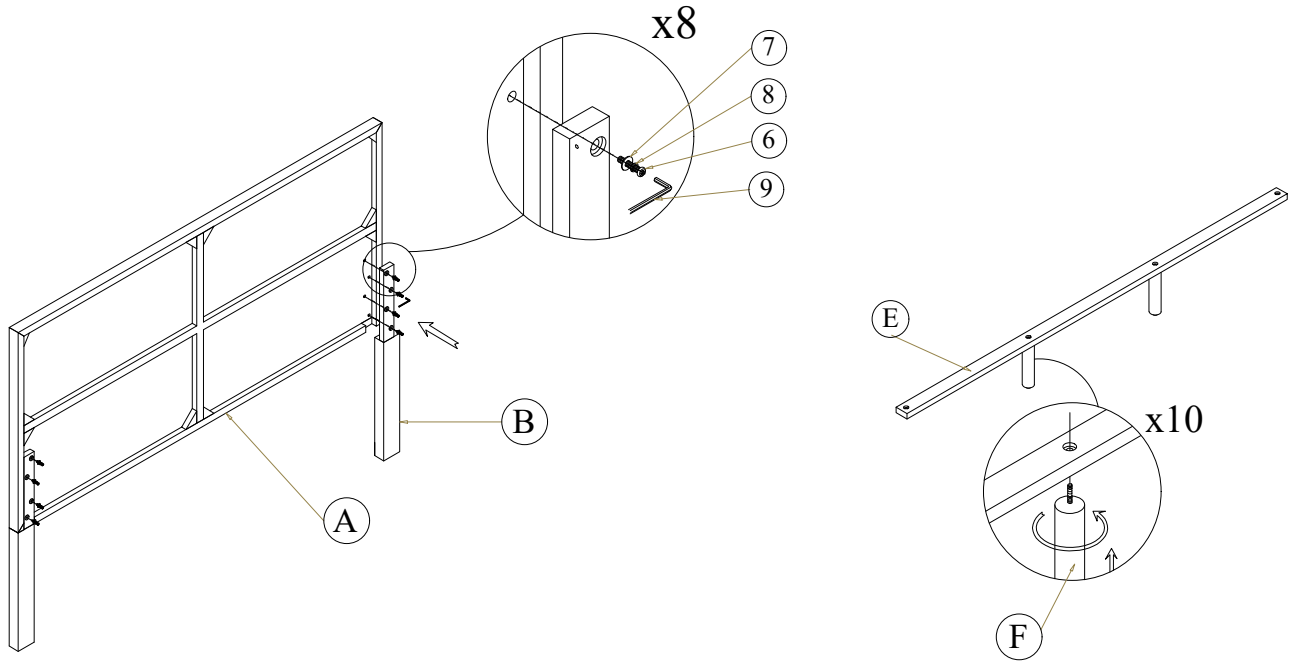













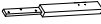

## ASSEMBLY INSTRUCTIONS FOR 203/303-H02/H03- FR02/FR03 HEADBOARD, FOOTBOARD, RAILS

Thank you for purchasing Bernhardt Furniture. Be sure to check all packing materials carefully to ensure proper assembly.

Please read all instructions carefully before starting the assembly process. Some parts are large and heavy and require at least two people to assemble, to prevent possible injury and/or damage to the furniture.



### PARTS LIST

NO.	DRAWING	DESCRIPTION	SIZE	QTY.	NO.	DRAWING	DESCRIPTION	QTY.
1		Stud bolts	5/16*100	8	A		Headboard	1
2		Washers	5/16	8	B		Leg	2
3		Nut	5/16	8	C		Footboard	1
4		Wrench	M12	1	D		Side rail	2
5		Screws	M4*20	10	E		Slat	5
6		Bolts	5/16*50	8	F		Center leg	10
7		Flat Washer	5/16	8				
8		Lock washer	5/16	8				
9		Allen key	M4*60	1				

### ASSEMBLY INSTRUCTIONS.

- 1- Attach Leg (B) to Headboard (A) using : Bolts (6), Flat Washers (7), Lock washers (8). Tighten bolts using provided Allen key (9).
- 2- Attach Center legs (F) to underside Slats (E) by hand.

### CLEANING INSTRUCTIONS

Clean surfaces with a soft damp cloth. Dry immediately.

# BERNHARDT **LOFT** BERNHARDT

## ASSEMBLY INSTRUCTIONS FOR 203/303-H02/H03- FR02/FR03 HEADBOARD, FOOTBOARD, RAILS

Thank you for purchasing Bernhardt Furniture. Be sure to check all packing materials carefully to ensure proper assembly.

Please read all instructions carefully before starting the assembly process. Some parts are large and heavy and require at least two people to assemble, to prevent possible injury and/or damage to the furniture.

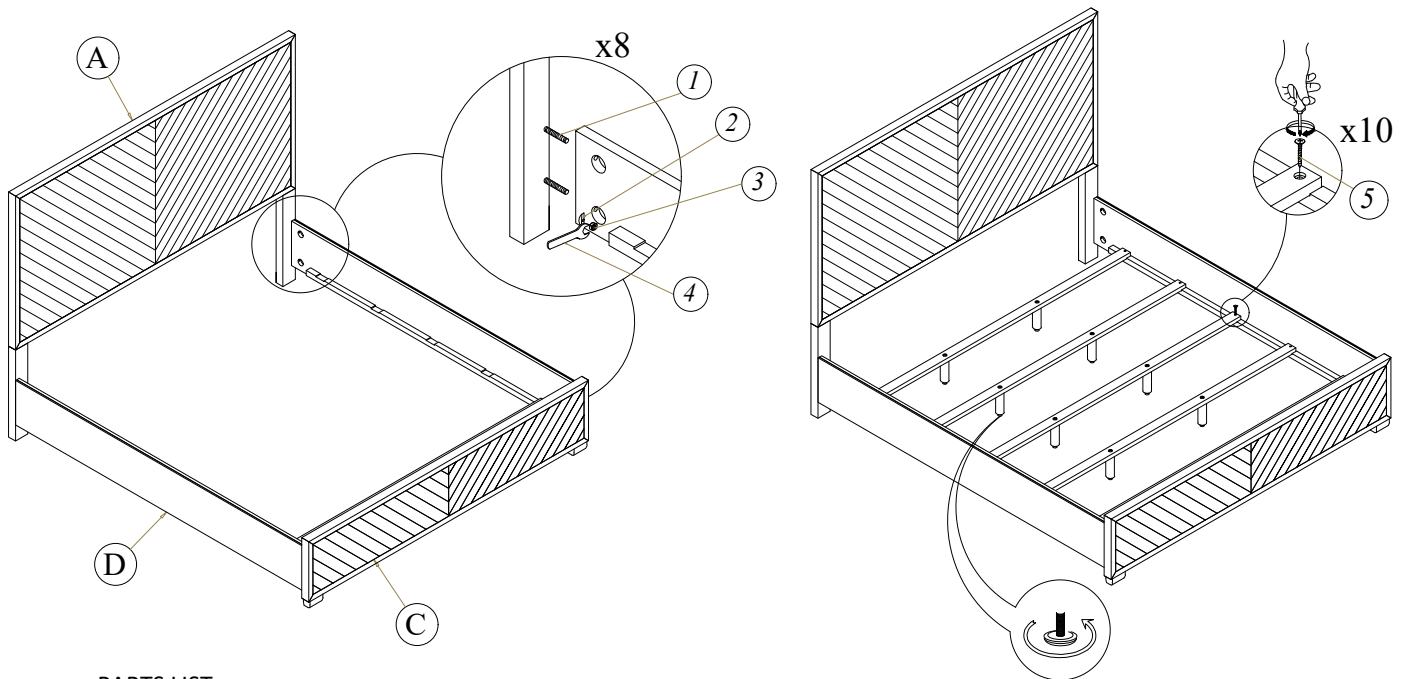

### PARTS LIST

NO.	DRAWING	DESCRIPTION	SIZE	QTY.	NO.	DRAWING	DESCRIPTION	QTY.
1		Stud bolts	5/16*100	8	A		Headboard	1
2		Washers	5/16	8	B		Leg	2
3		Nut	5/16	8	C		Footboard	1
4		Wrench	M12	1	D		Side rail	2
5		Screws	M4*20	10	E		Slat	5
6		Bolts	5/16*50	8	F		Center leg	10
7		Flat Washer	5/16	8				
8		Lock washer	5/16	8				
9		Allen key	M4*60	1				

### ASSEMBLY INSTRUCTIONS.

3- Attach Side rails (D) to the Headboard (A) and Footboard (C) using : Stud bolts (1), Washers (2), Nuts (3). Tighten Stud bolts with provided Wrench (4).

4- Attach Slats (E) to Side rails (D) using Screws (5).

5- Set item upright and level using adjustable levelers.

### CLEANING INSTRUCTIONS

Clean surfaces with a soft damp cloth. Dry immediately.