

INSTALLING VANITY WITH TWO PEOPLE IS HIGHLY RECOMMENDED
L'INSTALLATION DE LA VANITÉ AVEC DEUX PERSONNES EST FORTEMENT RECOMMANDÉE

Recommended Tools/Outils recommandés

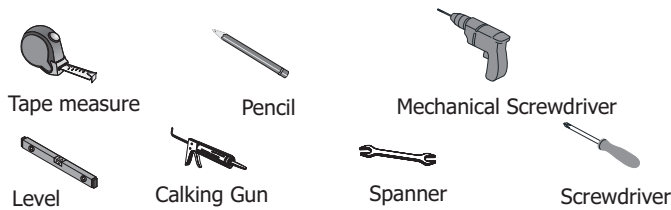

Main Body Parts/La partie principale du corps

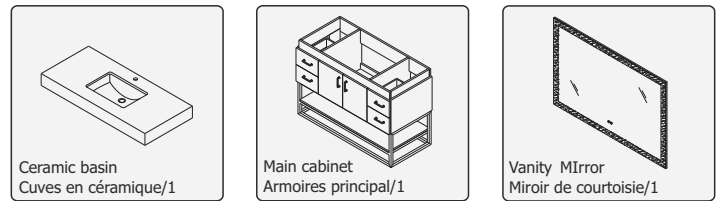

STEP #1

Assembly instructions/Instructions de montage

Mounting cabinet/Installation du cabinet

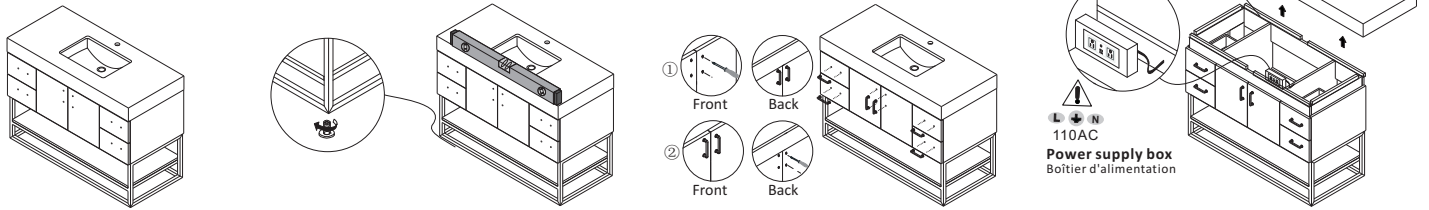

1. Main cabinet/Armoires principal **2. Adjusting cabinet foot/Pieds de cabinet de réglage** **3. Install the handle/Installer la poignée** **4. Tear off the EVA strip/Retirer la bande EVA**

STEP #2

STEP #3

Paste the countertop/Coller le comptoir

Hang the mirror/Accrocher le miroir

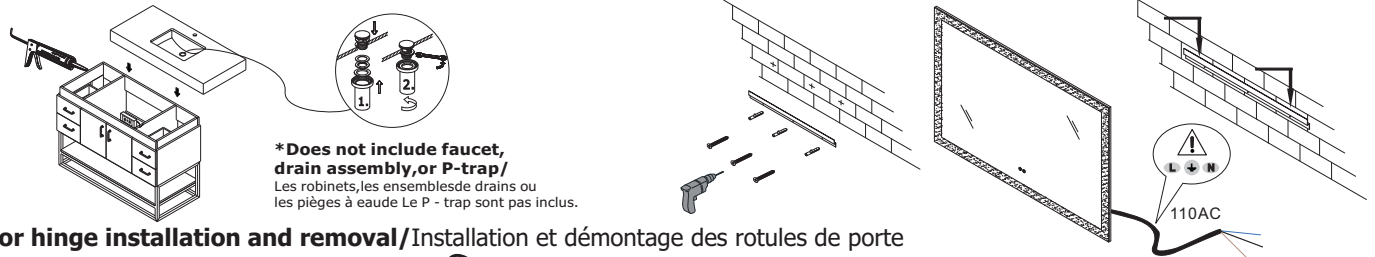

Door hinge installation and removal/Installation et démontage des rotules de porte

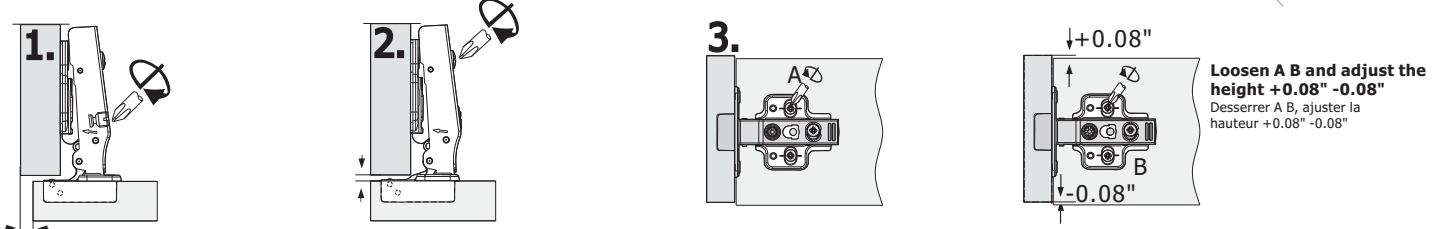

1. Side adjustment/ Ajustement du côté +0.08 -0.16 **2. Adjustable cassette/ Cassette réglable** +0.11 -0.04 **3. After adjustment, tighten A/B/ Après le réglage, vous devez serrer A/B**

Installation Instruction/Instructions d'installation

Removal of slide rail with front connector/ Démontage de la glissière avec connecteur frontal

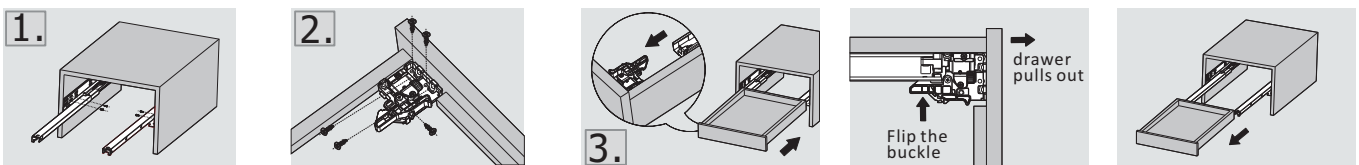

• Please check your product packaging to make sure the included accessories etc.
 Veuillez vérifier l'emballage de votre produit pour vous assurer que les accessoires inclus

Flip the buckle of the front connector, then pull the drawer out to complete the disassembly
 Retournez la boucle du connecteur avant, puis tirez le tiroir pour terminer le démontage

Diagram Specifications

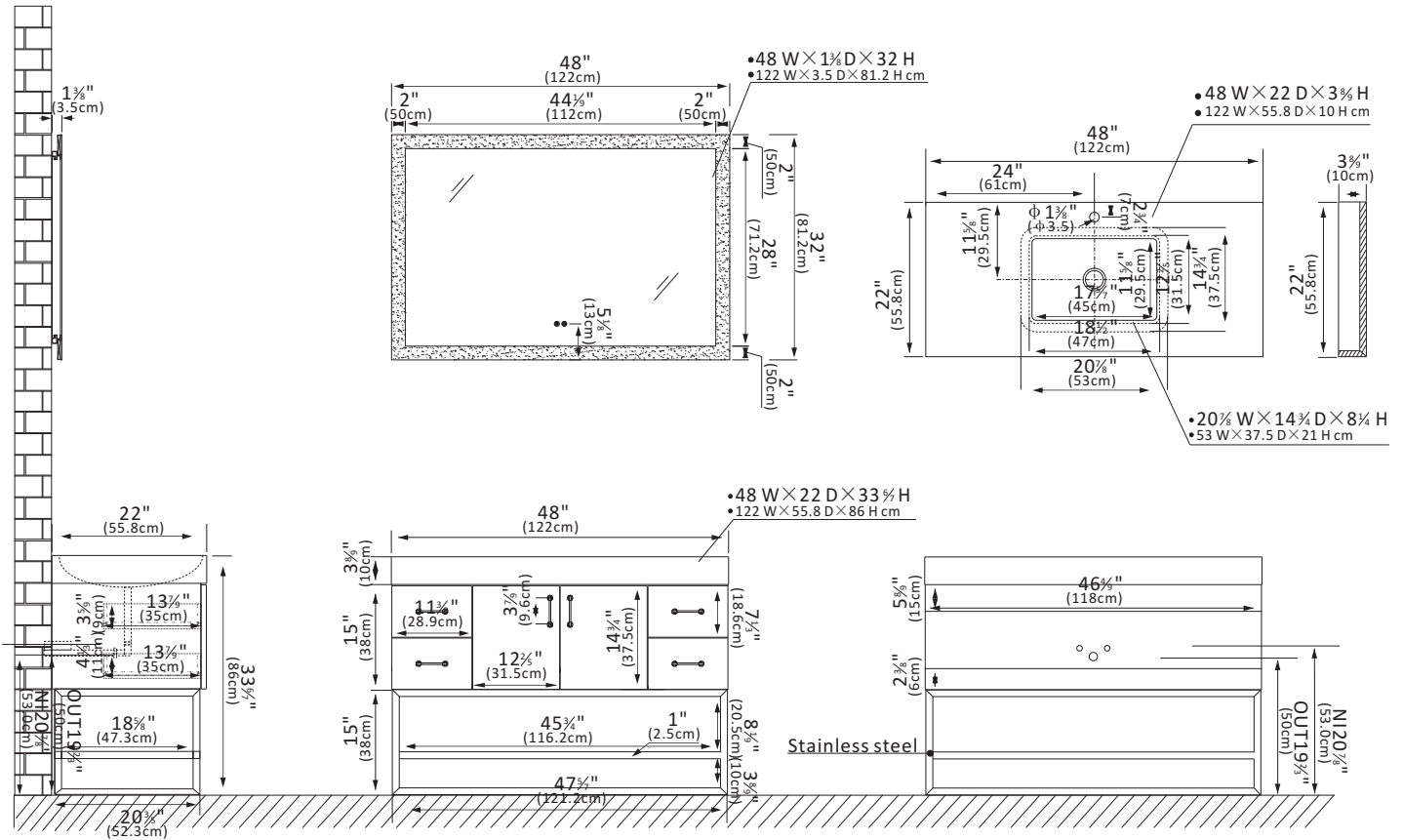

Vanity Care Guide

Vanity Care

- Avoid direct contact of sharp objects as they can cause exterior damage.
- Do not expose directly to the sun as it can cause aging and cosmetic damage.
- Avoid placing hot objects onto the vanity surface.

Countertop Care

- Kindly note that all our tops are sealed before shipping but may stain, scratch, or chip because they are porous by nature.
- Do not place hot items directly on the countertop as it can damage it.
- To prevent ring marks or staining, dry immediately.
- Place table mats beneath objects that can potentially scratch the surface.
- Use a clean, soft fabric to dust the vanity.
- Occasionally wash with a cloth dampened in warm water. If needed, apply a small amount of mild dishwashing liquid or stone soap to clean. Dry with a soft cloth.
- Refrain from using chemical cleaners, sprays, abrasive cleaners, or products that contain lemon, vinegar, or other acids.
- We advise to reseal top annually or when necessary.

Cleaning and maintenance

- Avoid using cleaning products that contain Bleach or Ammonia.
- Please use wood-friendly products on wooden base vanities.
- To adequately clean exterior surfaces, use natural cleaning solutions or soap

WARNING

This product can expose you to chemicals including Nickel compounds, which is known to the State of California to cause cancer. For more information visit [www. P65Warning. ca. gov](http://www.P65Warning.ca.gov)

WARNING

This product can expose you to Glass wool fibers (inhalable and biopersistent), which is known to the State Of California to cause cancer. For more information, go to www. P65Warnings. ca. gov

WARNING

Serious or fatal crushing can occur from furniture tip over . To prevent tip over this furniture must be used with the wall attachment device(s) provided.

Screw(s) and plug(s) for the wall are not included. Use screw(s) And plug(s) suitable for your walls. If you are uncertain, seek professional Advice. Read and follow each step of the instruction carefully.