

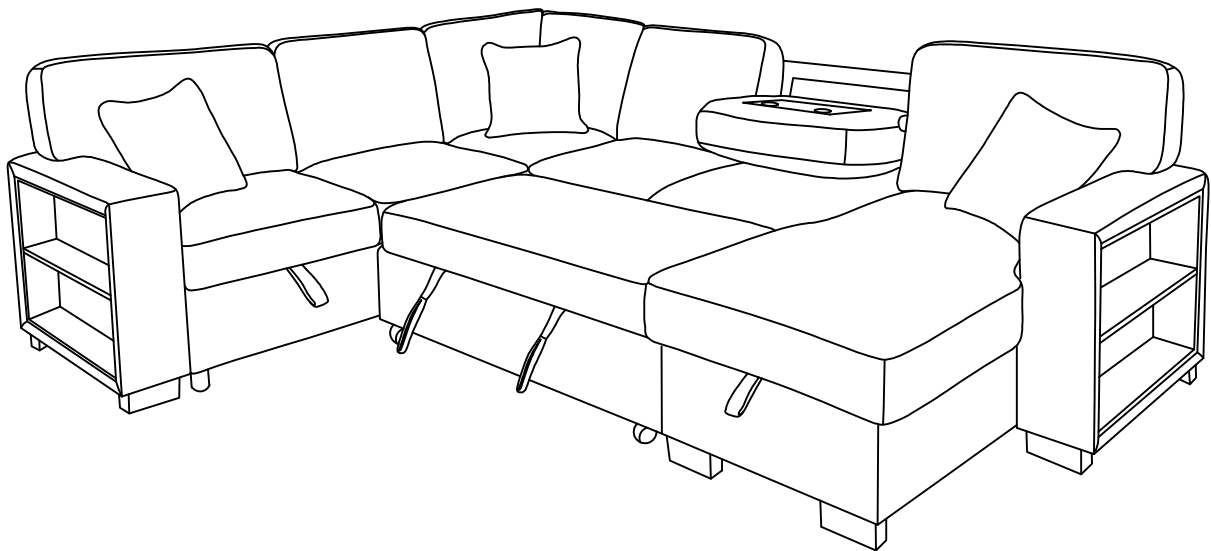













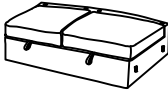

ASSEMBLY INSTRUCTIONS

SECTIONAL

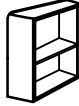

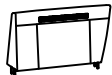

Caution: Please read instructions thoroughly before unpacking assembly parts. Sharp, exposed staple tips can cause injury, therefore, for your protection, please remove any exposed staple used in packing







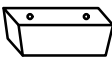























PARTS LIST

PART	DRAWING	DESCRIPTION	QTY	PART	DRAWING	DESCRIPTION	QTY
A		Left Arm	1	K		Backrest Of Right Love seat	1
B		Left Love seat	1	L		Backrest Of Chaise	1
C		Wedge	1	M		Left Back Cushion	1
D		Right Love seat	1	N		Back Cushion	2
E		Chaise	1	O		Back Cushion Of Wedge - Left	1
F		Right Arm	1	P		Back Cushion Of Wedge - Right	1
G		Backrest Of Love seat	3	Q		Right Back Cushion	1
H		Backrest Of Wedge - Left	1	S		Pillow	3
I		Backrest Of Wedge - Right	1				

HARDWARE LIST

PART	DRAWING	DESCRIPTION	QTY	PART	DRAWING	DESCRIPTION	QTY
#1		Screw M5 x 55mm	26	#4		Roller	4
#2		Legs	6	#5		Screw M4 x 25mm	16
#3		Legs	14				

Packed in 5 cases

Carton	Disignation	Part	Hardware
01	Left Arm	#A	
	Right Arm	#F	
02	Left Love seat	#B	
	Backrest Of Love seat	#G	
	Back Cushion	#N	
	Pillow	#S	
03	Wedge	#C	
	Backrest Of Wedge - Left	#H	
	Backrest Of Wedge - Right	#I	
	Back Cushion Of Wedge - Left	#O	
	Back Cushion Of Wedge - Right	#P	
04	Right Love seat	#D	
	Left Back Cushion	#M	
	Right Back Cushion	#Q	
05	Chaise	#E	
	Backrest Of Love seat	#G	
	Backrest Of Right Love seat	#K	
	Backrest Of Chaise	#L	
	Pillow	#S	
			 #1X4PCS  #3X4PCS
			 #1X4PCS  #3X4PCS
			 #1X18PCS  #2X6PCS  #3X6PCS  #4X4PCS  #5X16PCS

ASSEMBLY INSTRUCTIONS

THE PARTS ARE LOCATED INSIDE THE BOX AS BELOW:

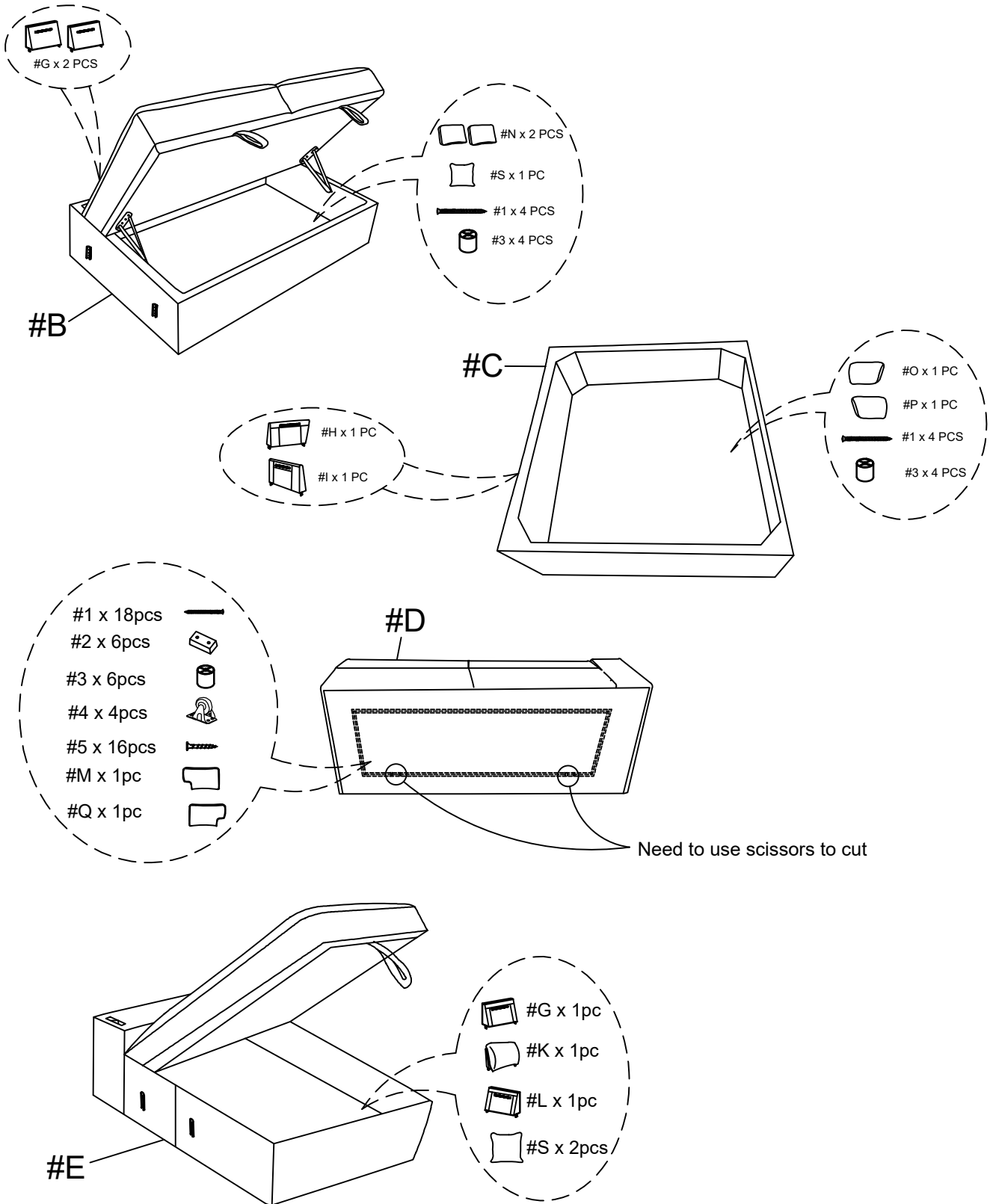

ASSEMBLY INSTRUCTIONS

STEP 1

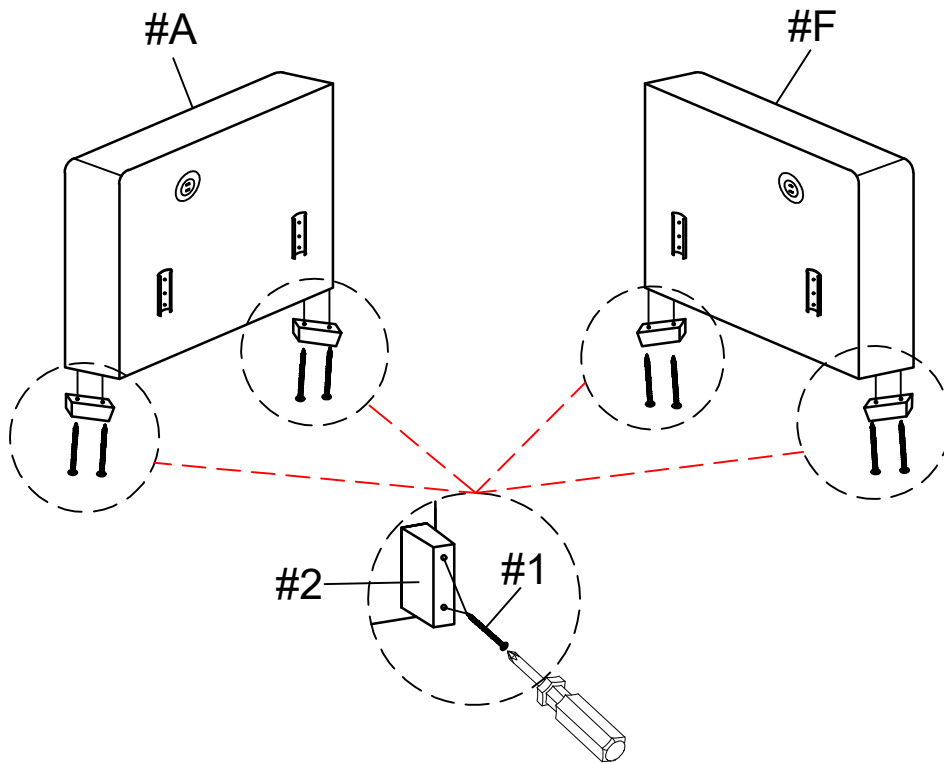

STEP 2

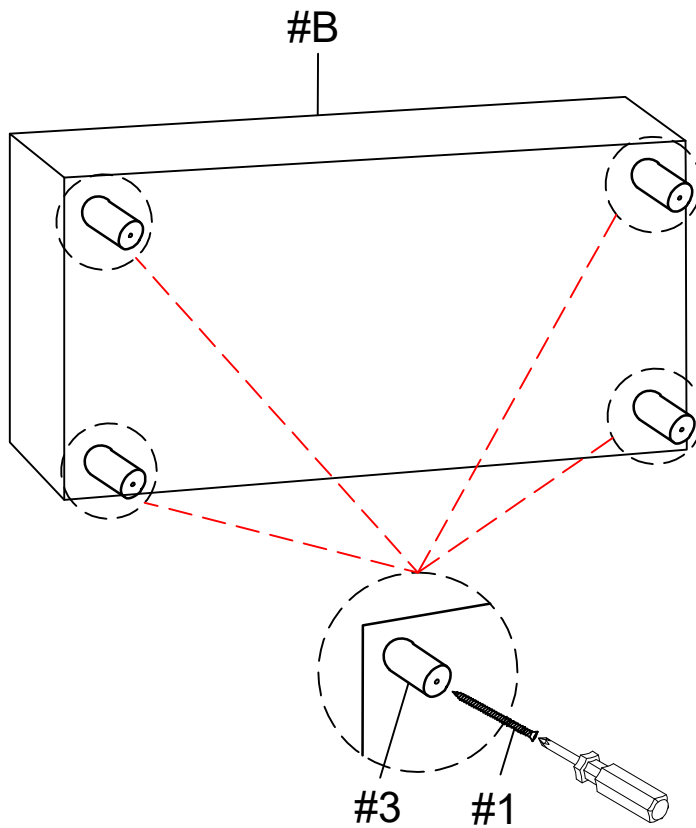

ASSEMBLY INSTRUCTIONS

STEP 3

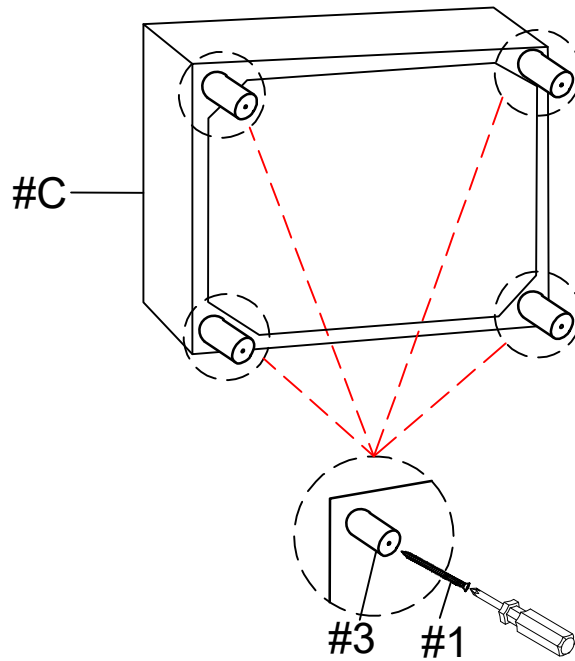

STEP 4

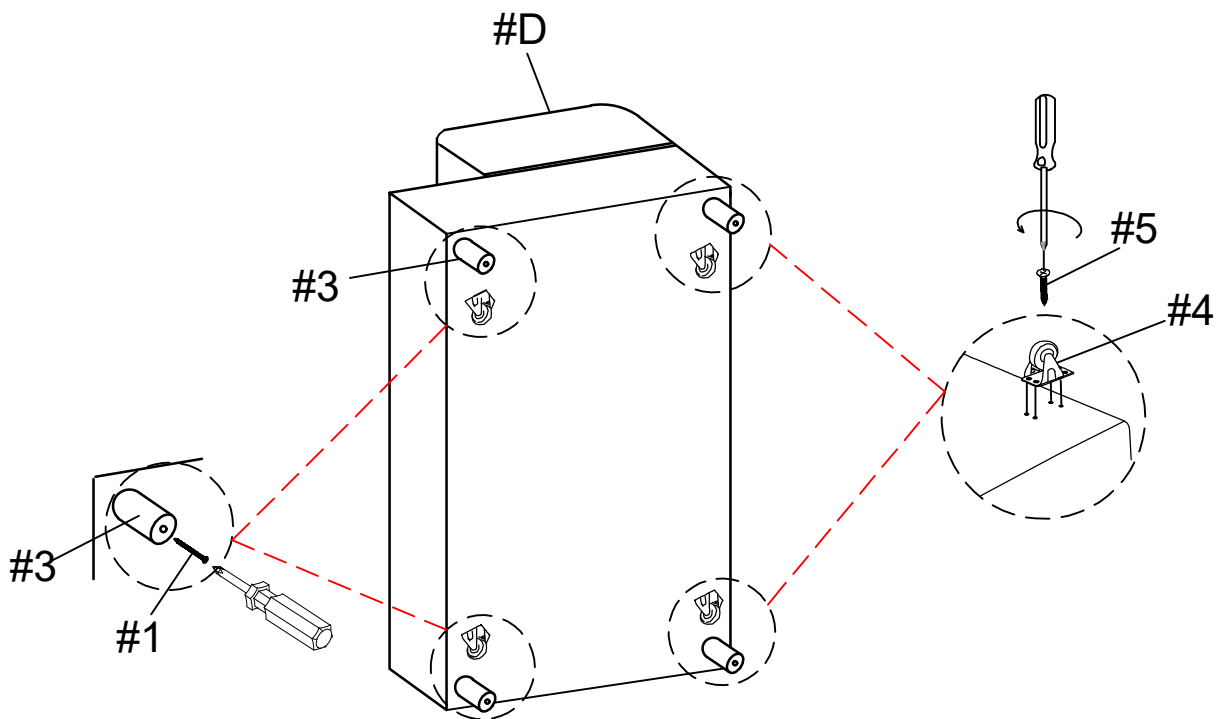

ASSEMBLY INSTRUCTIONS

STEP 5

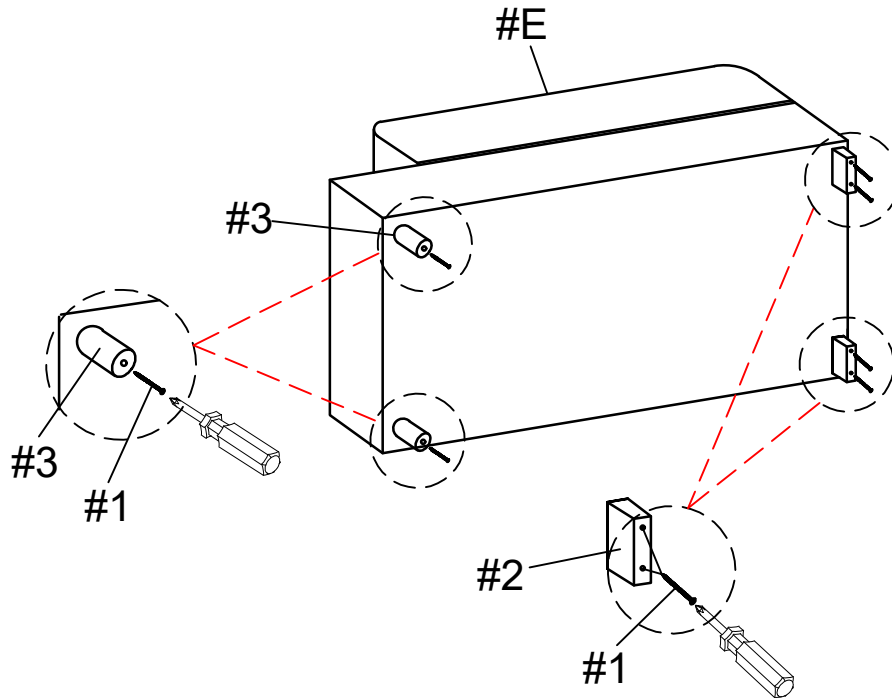

STEP 6

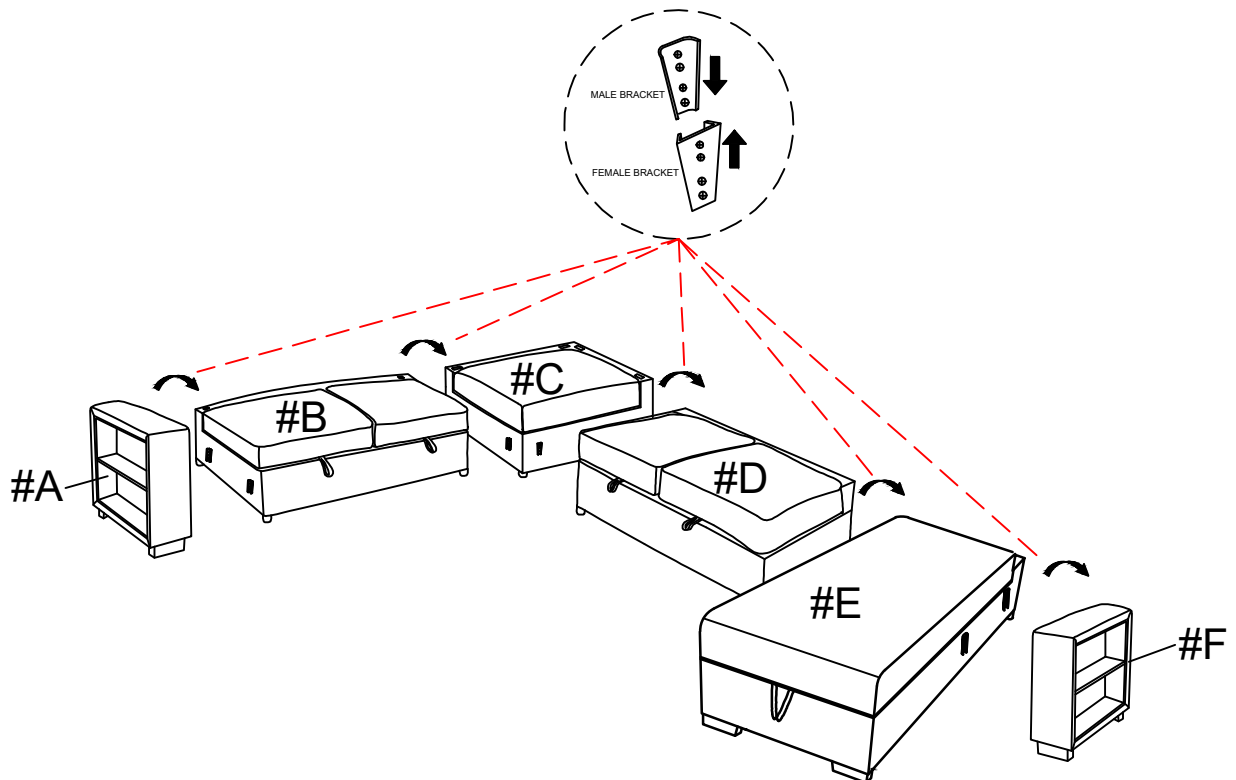

ASSEMBLY INSTRUCTIONS

STEP 7

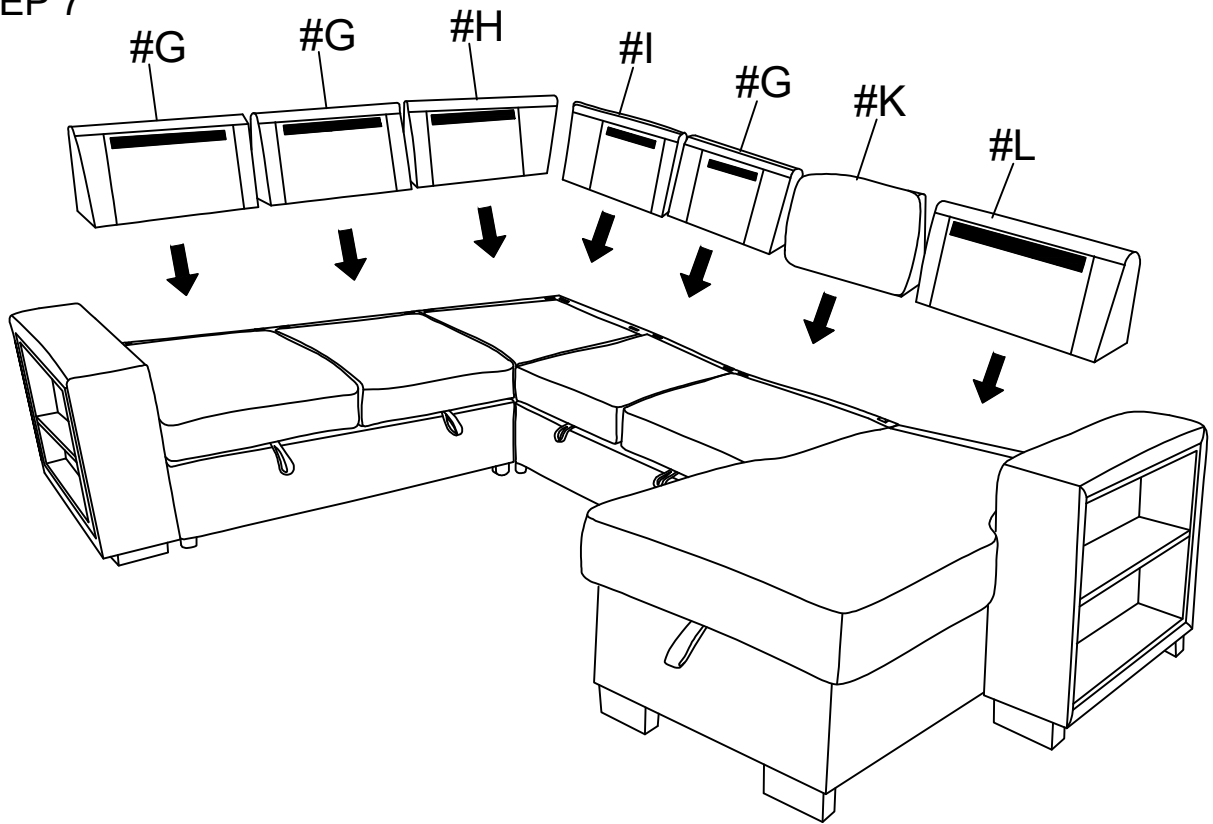

STEP 8

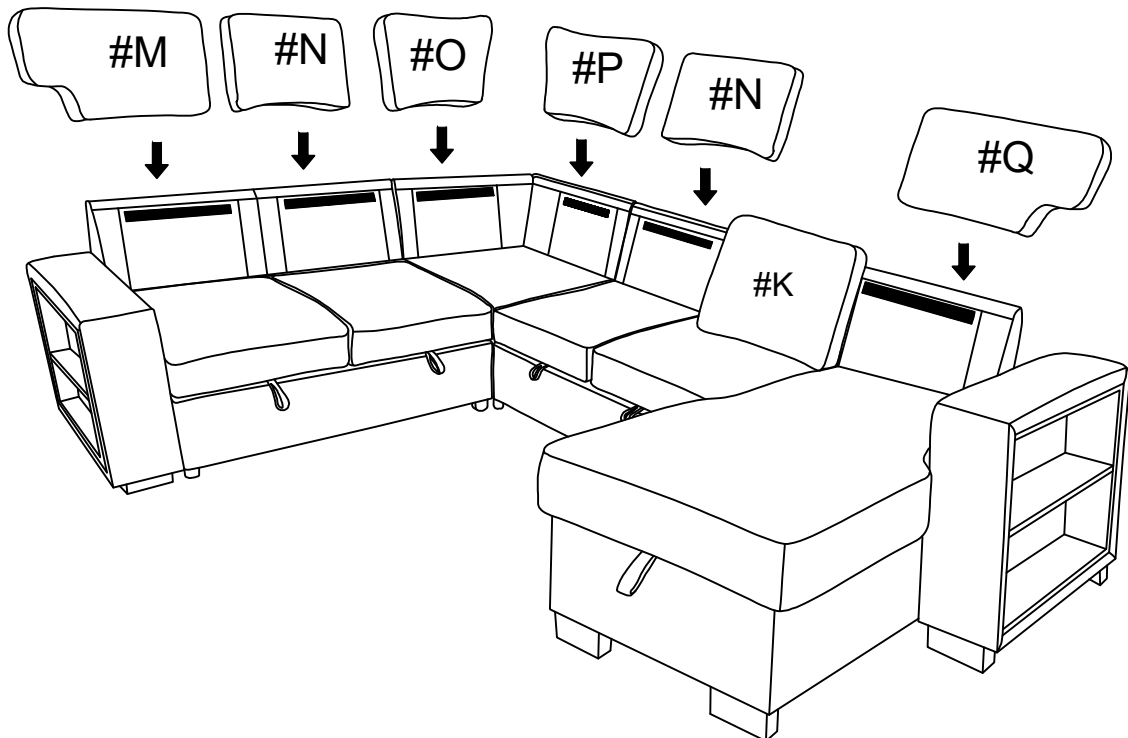

ASSEMBLY INSTRUCTIONS

STEP 9

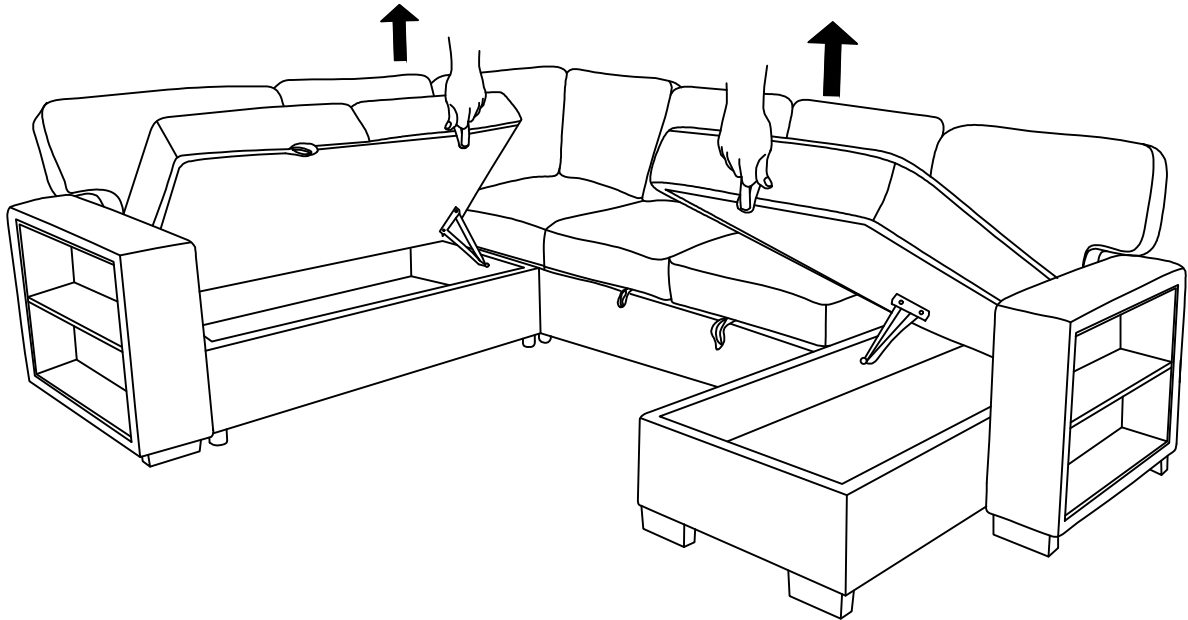

STEP 10

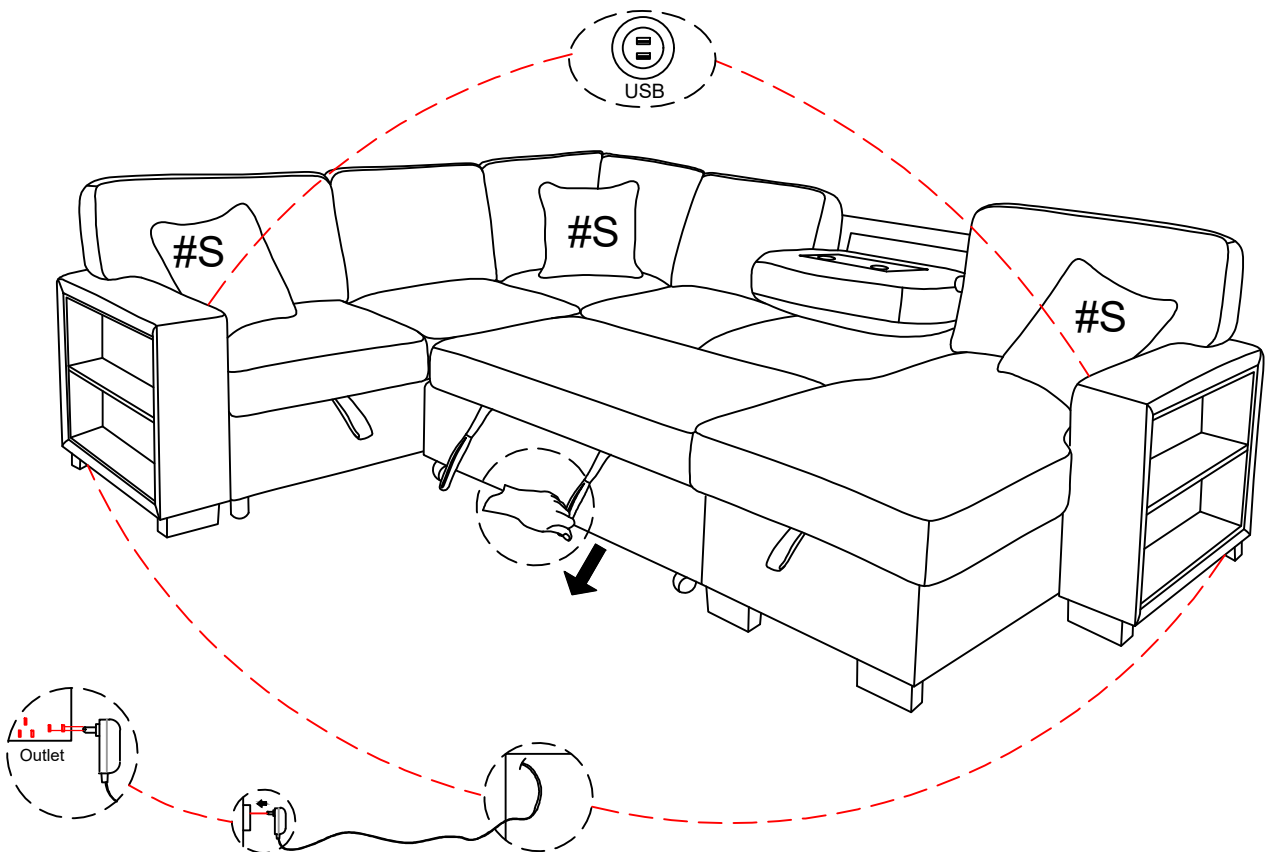



- Disconnect the electrical plug from the wall outlet before cleaning, moving, servicing or when not in use for an extended period of time.
- Plug directly into a wall outlet. Do not use an extension cord or adaptor
- Check the condition of the power transformers, electrical cords, plugs and connectors monthly. Keep the power adaptor and electrical cords away from heat sources. Never operate the unit with a damaged power adaptor, electrical cord, plug or connector.
- Before moving the product, please disconnect the electrical plug from the wall outlet and secure the mechanism to prevent unexpected opening or movement. Never move the product by the mechanism, legrest, handle, or reclining back. Do not attempt to disassemble or service the adaptor or motor. No serviceable parts are inside.
- Do not allow electrical cord to be pinched between moving parts or between the frame and the floor.
- Do not place cord under carpet or in location where it could become worn.
- Unplug the power cord immediately if you detect strange odors or fumes coming from the chair.

PLEASE KEEP ASSEMBLY INSTRUCTION FOR FUTURE REFERENCE