

ASSEMBLY GUIDE

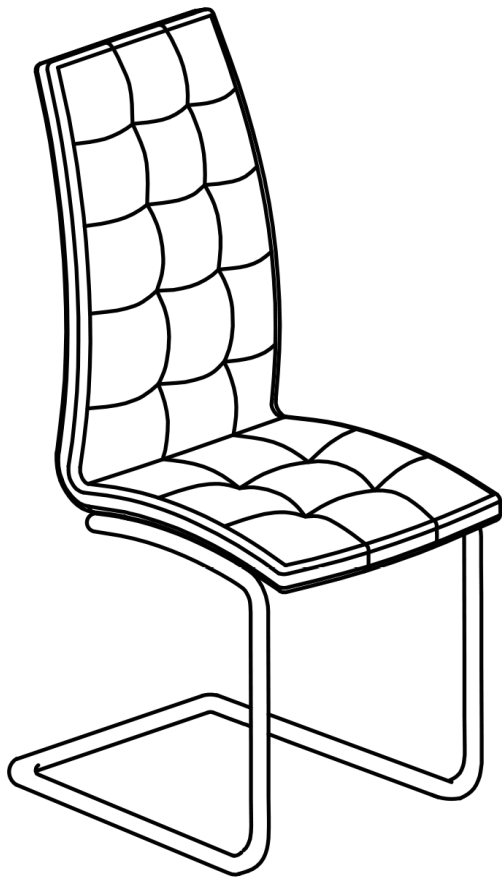

Important - Please read these instructions fully before starting assembly



**SAFETY AND
CARE ADVICE**



NO POWER TOOLS

SAFETY AND CARE ADVICE

- Check you have all the components and tools listed.
- Remove all fittings from the plastic bags and separate them into their groups.
- We do not recommend the use of power drills/drivers for inserting screws, as this could damage the unit. Only use hand screwdrivers and Allen keys.
- Keep children and animals away from the work area, small parts could cause choking if swallowed.
- Make sure you have enough space to layout the parts before starting.
- Assemble the item as close to its final position (in the same room) as possible.
- Do not overtighten the nuts to avoid causing damage to the threads.
- Only clean using a damp cloth and mild detergent, do not use bleach or abrasive cleaners.
- From time to time check that there are no loose screws on this unit
- This product should not be discarded with household waste. Take to your local authority waste disposal centre

IMPORTANT INFORMATION



ONE
PERSON



30 MINUTE
BUILD



MAXIMUM
CAPACITY 130Kg



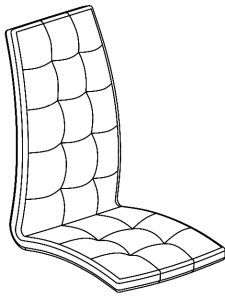

PLEASE CHECK CAREFULLY AND MAKE SURE YOU HAVE ALL FITTINGS AND TOOLS LISTED BELOW BEFORE YOU START.

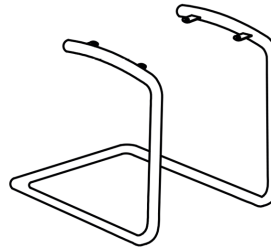

1 Back rest x 1



2 Leg frame x 1

<p>A</p>  <p>M6x16mm Allen Screw X4</p>	<p>B</p>  <p>M6x16mm Metal Washer X4</p>	<p>C</p>  <p>M6x10mm Spring Washer X4</p>	<p>D</p>  <p>M4 mm Allen Key X1</p>
--	---	--	---

NOTE: The quantities above are the correct amount to complete the assembly.
In some cases more fittings may be supplied than are required.

STEP 1

Place the seat [2] on a flat surface (ie. table top) with the back overhanging.
Line the legs [1] up with the seat holes.
Using allen key (D) tighten the chair legs onto the seat using fixings (A), (B) & (C)

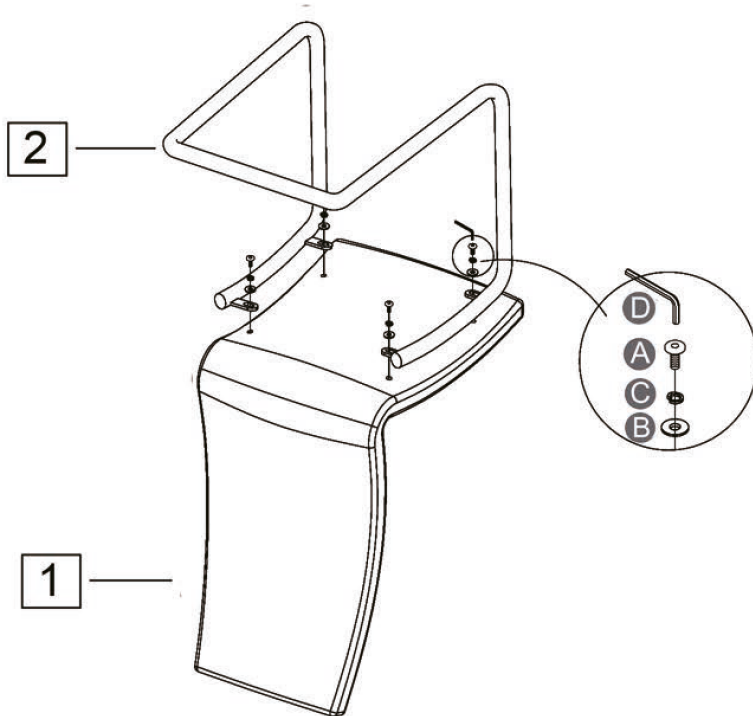

STEP 2

Sit on the chair and fully tighten all bolts.

