

ASSEMBLY INSTRUCTIONS

QUEEN BED

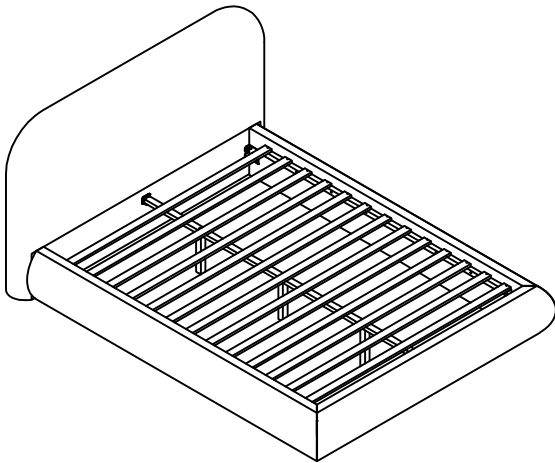

+ Do Not Use Power Tools



+ Suggested Adults

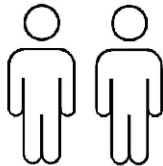

NOTE:

- 1 Read instructions cover to cover.
- 2 Save all packaging until assembly is completed.

1 IMPORTANT SAFETY INFORMATION

Do not assemble the product if any of the following parts arrived damaged:

- Part # 3 - Side Rails
- Part # 4 - Center Rail
- Part # 5 - Slat
- Part # 6 - Support Leg

2 IMPORTANT SAFETY INFORMATION

Assembly Step Ensure the side rail bracket is fully hooked onto bolt loosely threaded with both washers on the **OUTSIDE** of the bracket first, then proceed to fully tightening all 4 corners.

Assembly Step Fix slat using screw.
*Slats come packed in the bottom of headboard carton.

+ Parts Included

① Headboard
(1 pcs)

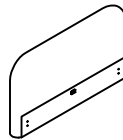

② Footboard
(1 pcs)

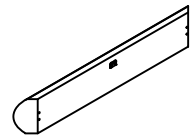

③ Side Rail
(2 pcs)

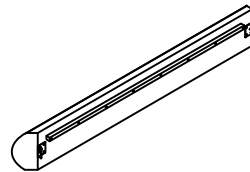

④ Center Rail
(1 pcs)

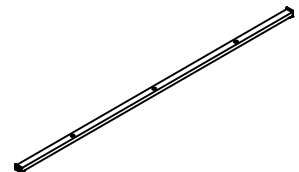

⑤ Slat
(13 pcs)

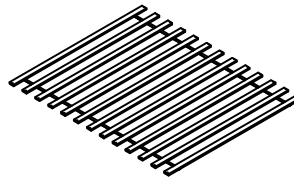

⑥ Support Leg
(3 pcs)

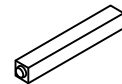

+ Hardware Included

Ⓐ Bolt 5/16"x1-1/2"
(11 pcs)



Ⓑ Flat Washer 5/16"
(11 pcs)



Ⓒ Spring Washer 5/16"
(8 pcs)



Ⓓ Screw M4x1-1/4"
(30 pcs)

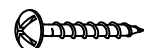

Ⓔ Allen Key M5x100mm
(1 pc)



ASSEMBLY INSTRUCTIONS

