

# Two-Piece Toilet

## Installation Instruction

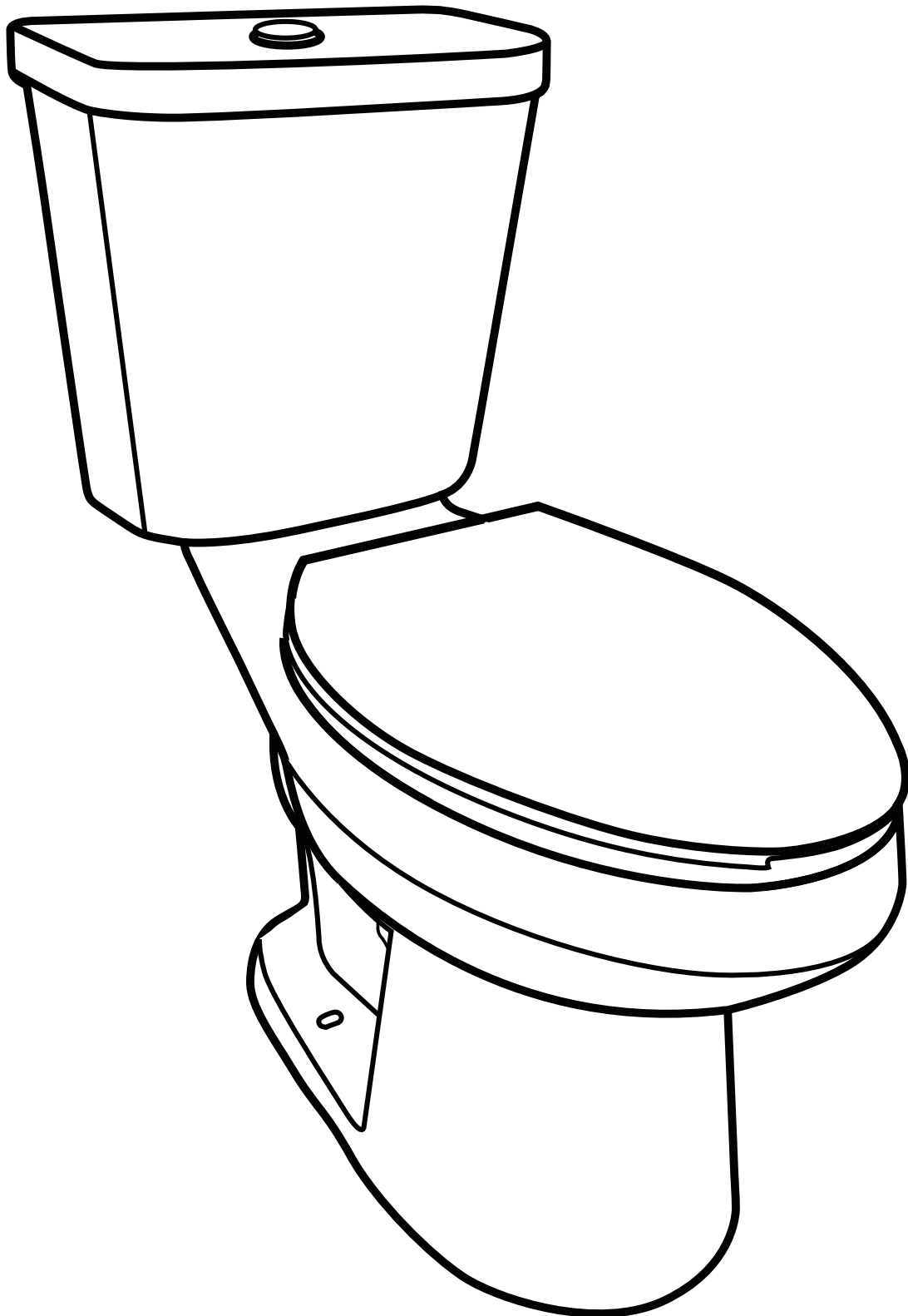

# THANK YOU!

Dear Valued Customer,

Thank you for choosing our ceramic Two-Piece Toilet. We hope our products can improve the quality of your life.

As a valued customer, your comments and opinions are very important for us. If you have any concerns, questions, or comments, we hope that you could bring them to our attention.

Please keep the box and packaging materials until your product is completely installed.

If you have any questions or concerns, please contact us:

+1 607 645 4819

[lyla@miuara.com](mailto:lyla@miuara.com)

Sincerely  
Service Team



# Two-Piece Toilet Installation Instruction



## Prior to Installation:

- Before installation, please make sure that the toilet without damaged during shipping.
- Observe all plumbing and building codes in accordance with your state and local requirements.
- Remove old toilet.
- Make sure mounting surface is CLEAN and LEVEL.

### **General Recommendations:**

Please read installation and maintenance instructions thoroughly before installing the toilet.  
Be sure to use proper tools and always wear proper personal safety accessories for your protection.

# Two-Piece Toilet Installation Instruction

## SUGGESTED TOOLS AND MATERIALS

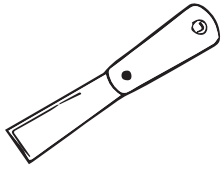

Putty Knife

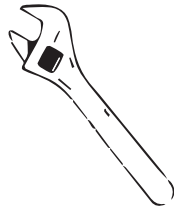

Wrench

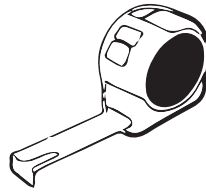

Tape Measure

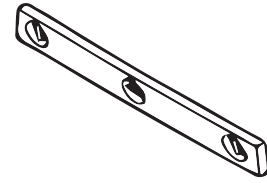

Level

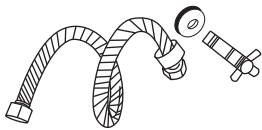

Water Supply Kit

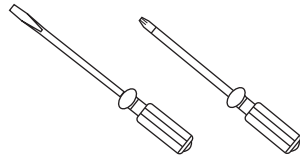

Flat/Cross Head Screwdriver

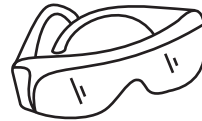

Safety Glasses



Hacksaw

- Installation tools are not provided, please prepare by yourself.

## PARK LIST

Push button, tank lid, water fitting, soft-close toilet seat, wax ring, bolts kit, bolt covers, installation instruction.

The step-by-step guidelines in the installation instructions are a general reference for installing a Two-Piece Toilet. Should there be any discrepancies, we cannot be held liable. It is recommended to install all Products by hiring a licensed professional.



1. Read the complete instruction manual before beginning installation.

2. Confirm that your model will fit in intended location and plumbing fixtures are located where legally required before beginning installation.



3. Not all drawings on this manual are drawn to scale. Please refer to the model chart.

4. Two people are recommended to install and move this product.



5. Product is FRAGILE! To avoid breakage and possible injury handle with care.

NOTE: Specialized tools may be necessary to install the Two-Piece Toilet, plumbing not included.

# Two-Piece Toilet Installation Instruction

## INSTALLATION STEPS

### 1. Remove Old Toilet

- Turn off the water supply.
- Flush the toilet to empty the tank. Remove any water left in the tank or bowl.
- Disconnect the supply line from the tank.
- Remove decorative caps. Unscrew nuts that attach the toilet to the floor.
- Remove toilet.
- Make sure the water supply valve is shut off before installation.
- Remove old closet bolts from closet flange. Clean any old wax, putty, etc. from base area.

### IMPORTANT NOTE REGARDING WATER SUPPLY:

Before installation ensure that the shut-off valve is greater than 7 1/2" from the center of the drain to the center of the shut-off valve on either side.

**NOTE: This is a true 12" rough-in toilet from finished wall to center of the drain (no less than 12" ). Baseboard thickness may reduce rough-in dimension.**

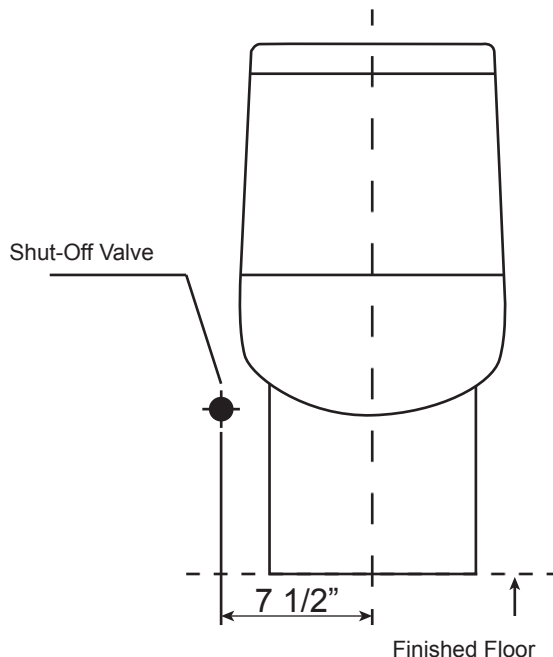

**NOTE: Drawings may not exactly define contour of the product.**

# Two-Piece Toilet Installation Instruction

## 2. Install Toilet Floor Bolts

- Install floor bolts to flange channel, turn 90° and slide into place 6" (152mm) apart and parallel to wall.

Note: 1) Ensure top surface of the drain flange is flush to the finished floor, or does not exceed 1/2" (1.27 cm) above the finished floor. Otherwise, consult with a plumbing professional.  
2) Toilet Flange is not included.

Drain Flange

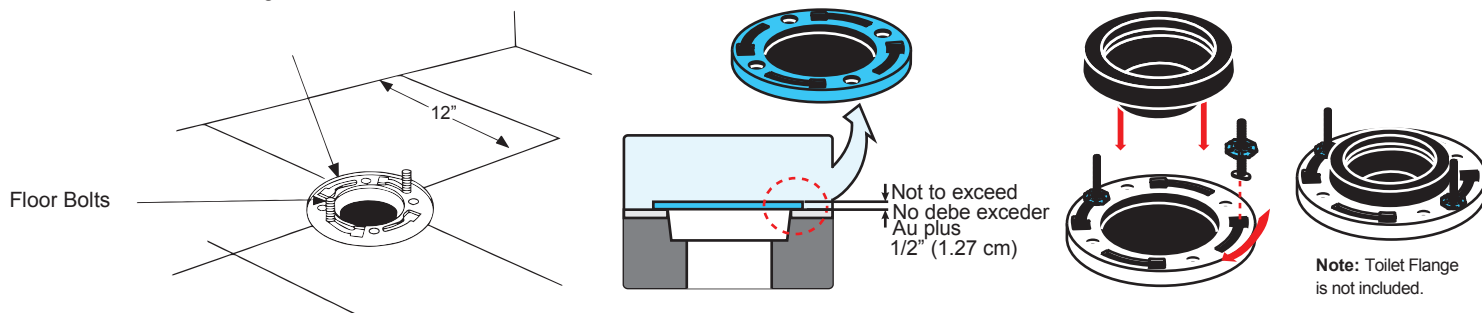

## 3. Install Wax Ring

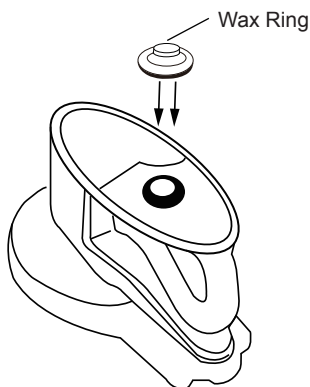

- Invert toilet on floor (use cushion to prevent damage), and install wax ring evenly around waste flange, with tapered end of ring facing toilet.

## 4. Position Toilet on Flange

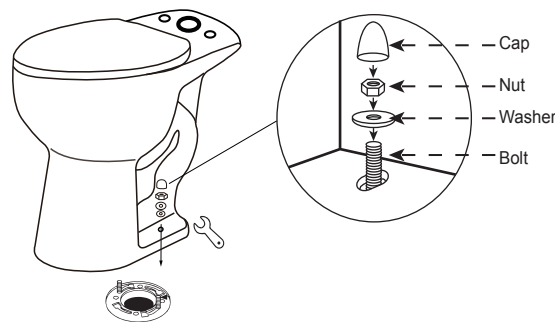
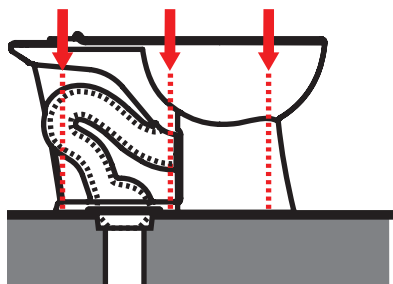

- Lower the toilet onto the closet bolts, so the bolts project through mounting holes in base of toilet.
- Rock to press the bowl completely downward on the wax ring and flange.
- Apply weight evenly until toilet is flush to the floor.
- Do not move after placement or watertight seal may be broken.
- Install the washer and nut in sequence, then alternately tighten the nut until the toilet is firmly sealed to the floor.
- Install the cap.

**NOTE:** Drawings may not exactly define contour of the product.

# Two-Piece Toilet Installation Instruction

## 5. Install Toilet

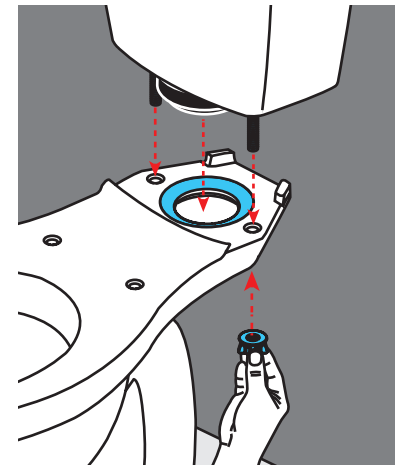
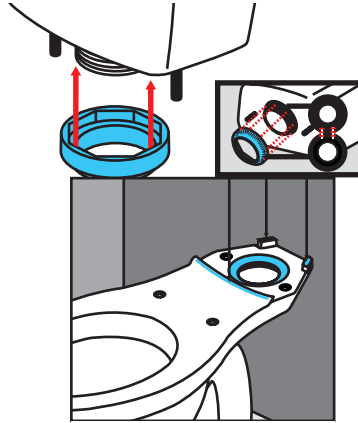
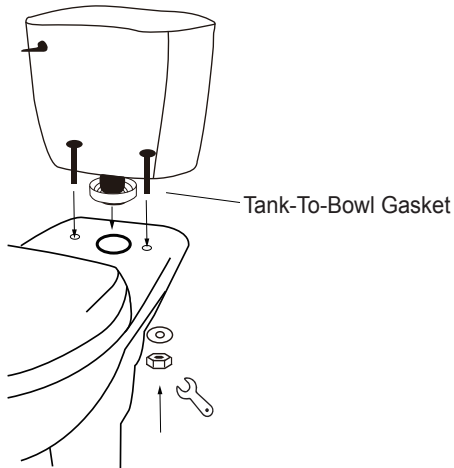

- Place the tank gasket over the tank nut ensuring there are not gaps between the gasket and the tank.
- Put the two tank bolts into the tank mounting holes, then pick up the tank and connect it after guiding the bolts to align the tank with the bowl.
- Tighten nuts alternately to make them stable on the toilet bowl.

## 6. Install Toilet Seat



- Insert the screw set on the hinge base through the holes on the pan.



- Tighten the seat screws, but not fully allowing you movement to adjust the seat cover properly.

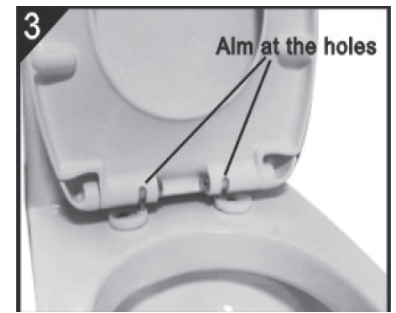

- Aim at the holes and adjust the hinge base to make the seat cover and pan match. Take out the seat cover once the installation position is confirmed.



- Fix the hinge base on the pan firmly.



- Put the cap into the hinge base



- Fix the seat into the hinge base

**NOTE:** Drawings may not exactly define contour of the product.

# Two-Piece Toilet Installation Instruction

## 7. Install Flush Button-Double Flush Buttons on Top Water Tank Style

### 1. The profile of installation

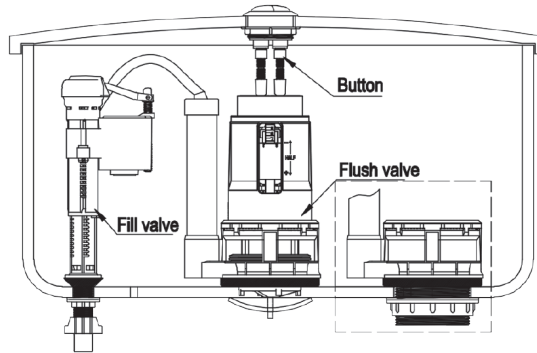

### 2. Steps

#### 1>Preparation

Pls clean the tank and pipe concerned if it is old one.

#### 2>Installation

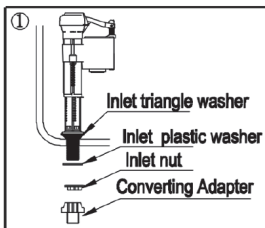

Take off the adapter, inlet nut and inlet plastic washer, insert the fill valve into inlet hole from inside of tank, re-assembly the plastic washer and inlet nut, adjust the fill valve properly, and tighten the inlet nut. Then twist the adapter tightly.

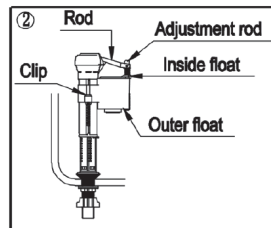

Water lever adjustment: Take out the clip and adjust outer float to proper position. Reinsert the clip, twist the adjustment rod to make the rod vertical naturally.

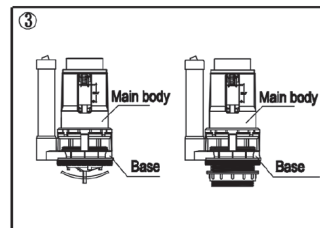

Twist the main body out of the base.

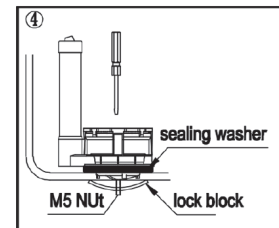

Twist 3 lock blocks to the end of M5 nuts respectively, insert the base to the outlet hole from inside tank, and adjust the base properly, then tighten the lock blocks with screw driver to make the sealing washer fully match the outlet hole.

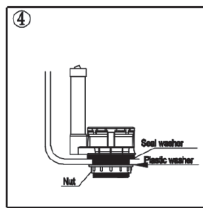

Screw the nut out of threads and take out of washers; Put the base into the tank hole and adjust to be the right position; And then screw the nut and seal washer into the threads, meanwhile keep the seal on the tank hole tightly.

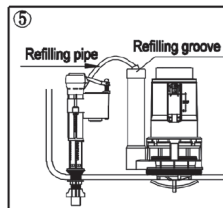

Put the flush valve into the base and take the refilling pipe into the groove.

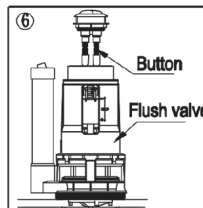

Insert the push button into the button hole, turn and adjust the push rod into proper height to make it just touch the top of full/half flush button.

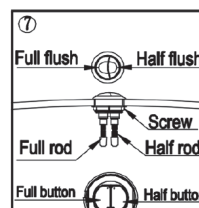

Adjust the rod relevant to touch the buttons concerned.

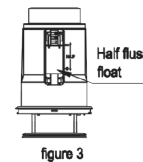
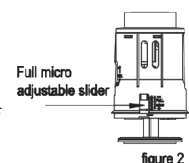
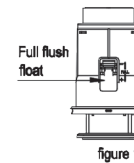

### 3. FLush volume adjustment

- 1>Adjust both full and half floats to the bottom position. Keep the openings fully open for both full and half micro adjustable sliders. (See figures 1-4)
- 2>Full flush volume adjustment: Fill the water tank up, press full flush push button. Raise the full float when larger flush volume (the higher the float is, the smaller the full flush volume is), and vice versa.
- 3>Half flush volume adjustment: Fill the water tank up, press half flush push button. Raise half float when larger flush volume (The higher the float is, the smaller the flush volume is), and vice versa.

### 4. Troubleshooting

#### 1>Flush valve

NO.	Abnormal issues	Possible reason	Method
1	Outlet hole leaks	Flush valve is not positioned properly	Tighten the lock blocks
2	Flush valve leaks	Bottom surface of base is scratched or sealing washer is deformed	Replace base or sealing washer
3	Flush volume too large/small	Improper setting of half flush float and full micro adjustable slider	Reset the position of half flush float and full micro adjustable slider
4	Flush no water or litter water	Push rod is too short	Adjust the length of push rod

#### 2. Fill valve

No.	Abnormal issues	Possible reason	Method
1	Valve does not fill the tank	Supply line jammed or float is held up in water stopping position	Clean debris in supply line; Adjust the rod into naturally vertical position by twist the adjustment rod
2	Tank fills too much or only partially	Improper position of float	Take off the clip and adjustment rod, reset the outer float into proper position, then refix the clip and adjustment rod
3	Inlet hole leaks	Inlet nut is loose or the ceramic hole is deformed	Tighten the inlet nut or repair the ceramic toilet
4	Water stops filling when water level lower than outer float	Debris or dirt on one-way valve	Bring out the one-way valve, clean the debris or dirt
5	Take too long/short time to fill the tank	The pressure of supply line is too low/high	Adjust the pressure of supply line
6	Refill tube sticks with other parts	The position of fill valve is not proper	Re-position Fill valve

Pls give the instruction to the final consumer;

Pls regard the products as real carefree of discrepancy as indicated pictures

**NOTE:** Drawings may not exactly define contour of the product.