

Headboard Assembly Instructions

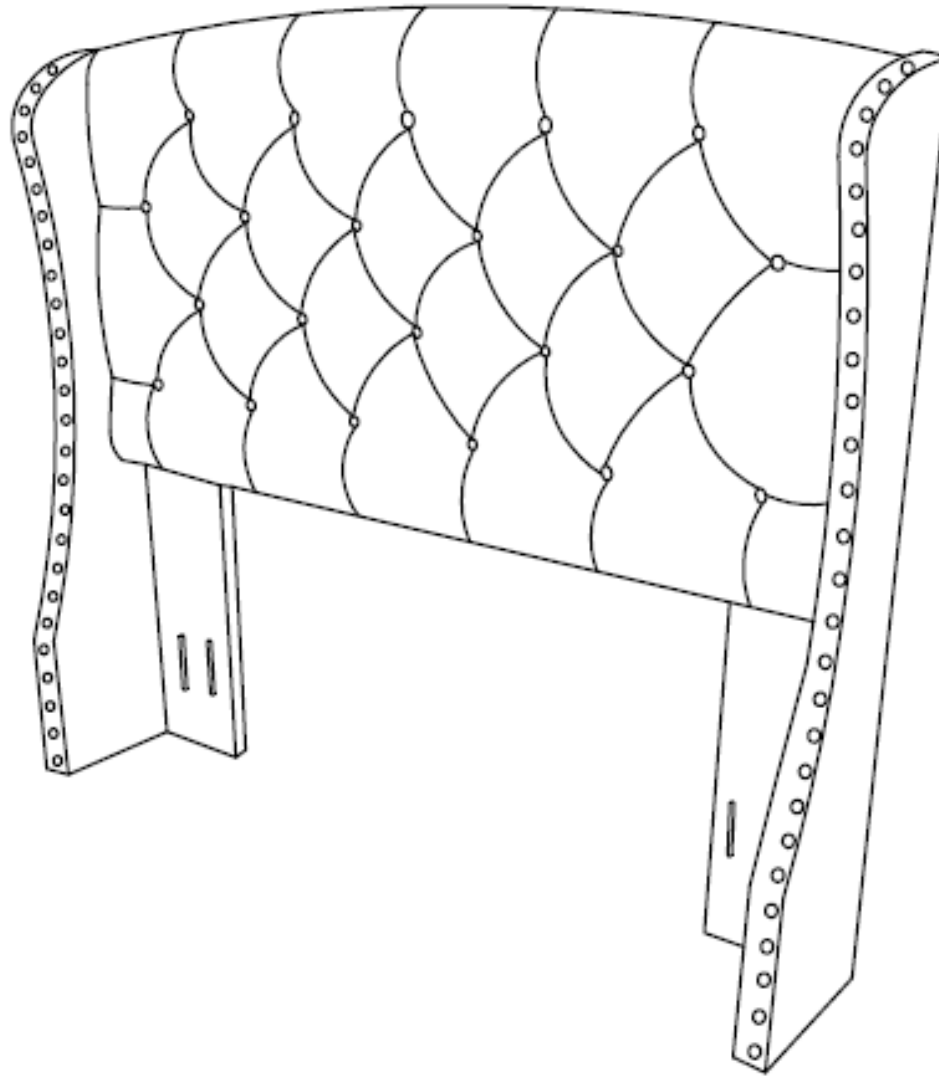

Headboard Assembly Instructions

NOTE: Place all parts on a clean and smooth surface (rug, carpet) to avoid the parts from being scratched.

NOTE: Follow assembly instructions step by step.

NOTE: Do not completely tighten screws until the headboard is fully set up.

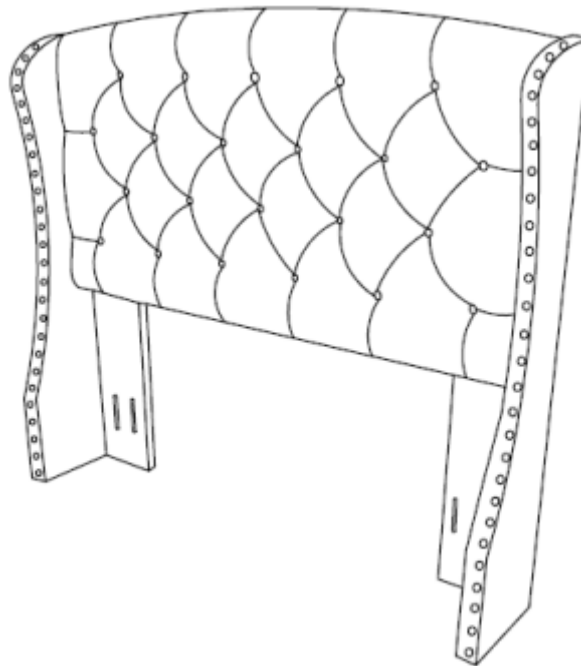

Headboard Assembly Instructions

PART LIST:

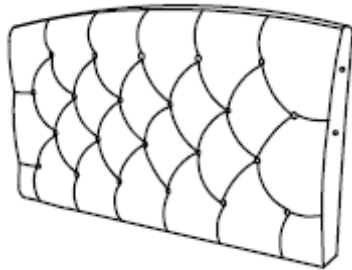

① Headboard 1pc

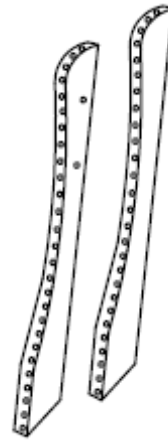



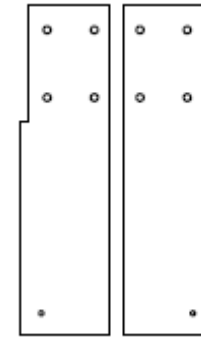



② Wings 2pcs



③ Legs 2pcs

HARDWARE LIST:

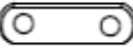
LABEL	PICTURE	DESCRIPTION	QTY	LABEL	PICTURE	DESCRIPTION	QTY
A		2" BOLT	12	E		SML FLAT WASHER	4
B		ALLEN WRENCH	1	F		LRG FLAT WASHER	16
C		HEX NUT (to attach headboard to metal bed frame)	4	G		2-1/2" BOLT (to attach headboard to metal bed frame)	4
D		3/4" BOLT	4	H		METAL PLATE	2

Headboard Assembly Instructions

STEP 1: Attach the two legs to the headboard using the 8- 2" bolts and small washers making sure the hole on the bottom of the leg is on the outside edge
(See below diagram)

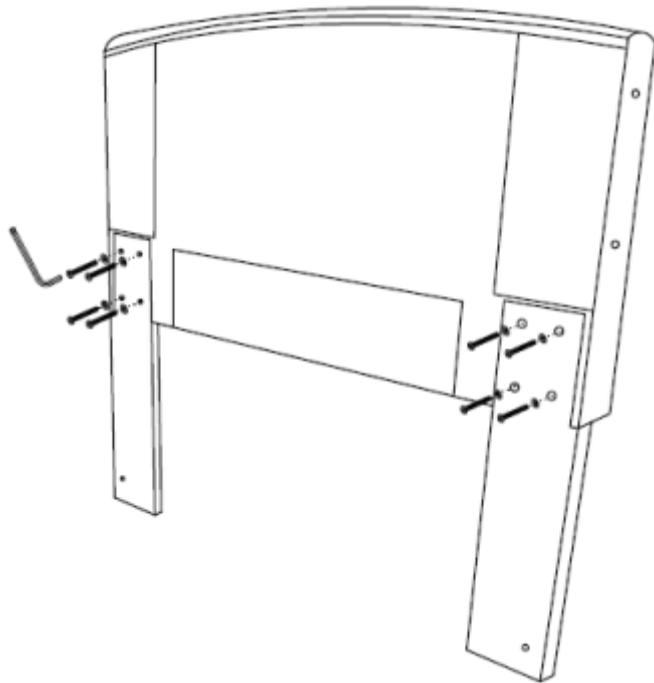

STEP 2: Now attach the wings, first remove the velcro panel on the top corners of the backside of the headboard. Using 4- 2" bolts and small washers, attach the wings to the headboard (see diagram)

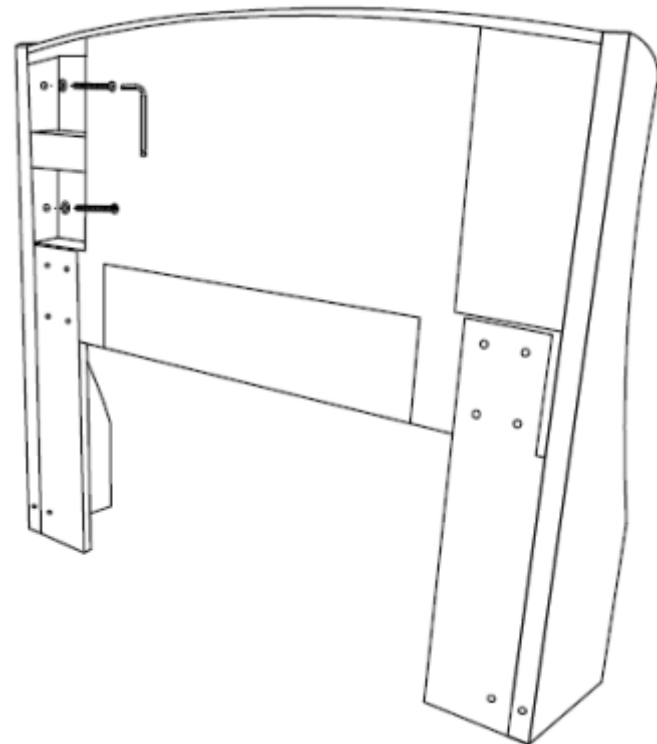

Headboard Assembly Instructions

STEP 3: After the wings are attached at the top, secure the bottom of the wing to the bottom of the legs using the metal plates and 3/4" bolts (see diagram)

STEP 4: After headboard is fully assembled, align slots at the bottom of headboard legs with attachment holes on metal bedframe, use the provided 2-1/2" bolts, washers & hex nuts to attach headboard to metal bed frame.

