

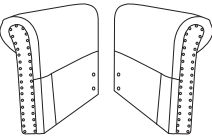

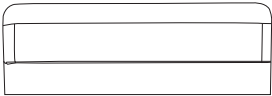

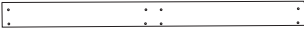





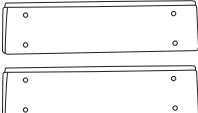

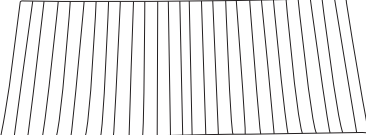
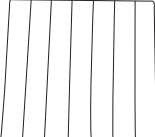

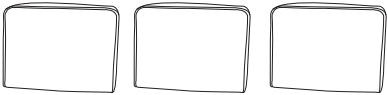

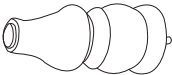

# Assembly Instruction

NO	PARTS	QTY
A		2 PCS
B		1 PC
C		1 PC
D		1 PC
E		2 PCS
F		2 PCS
G		1 PC
H		1 PC
I		1 PC
J		8 PCS
K		2 PCS

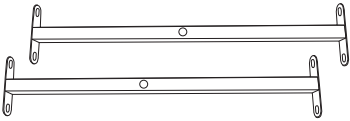
NO	PARTS	QTY
L		3 PCS
M		1 PC
N		40 PCS
O		4 PC
P		8 PCS
Q		1 PC
R		44 PCS
S		1 PC
T		2 PCS
U		1 PC
V		PAD 9 PCS
W		GASKET 9 PCS

**STEP 1**

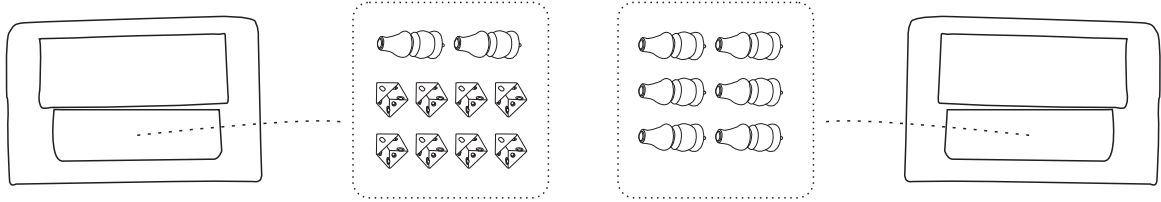

**STEP 2**

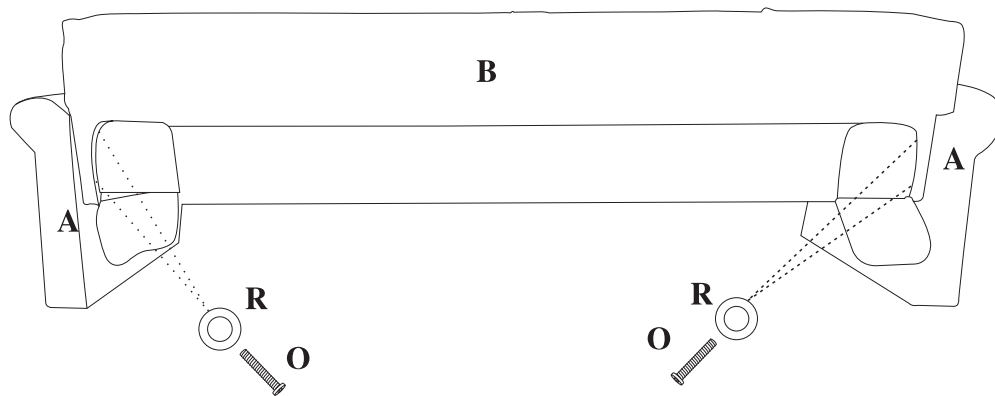

**STEP 3**

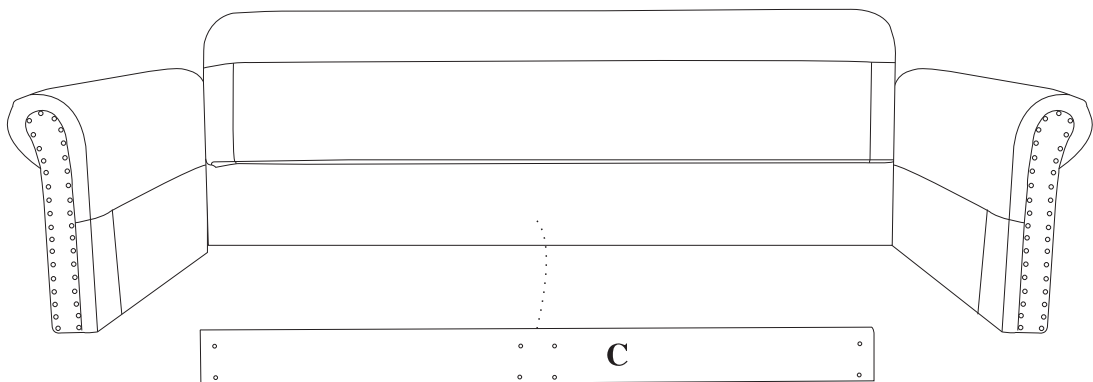

**STEP 4**

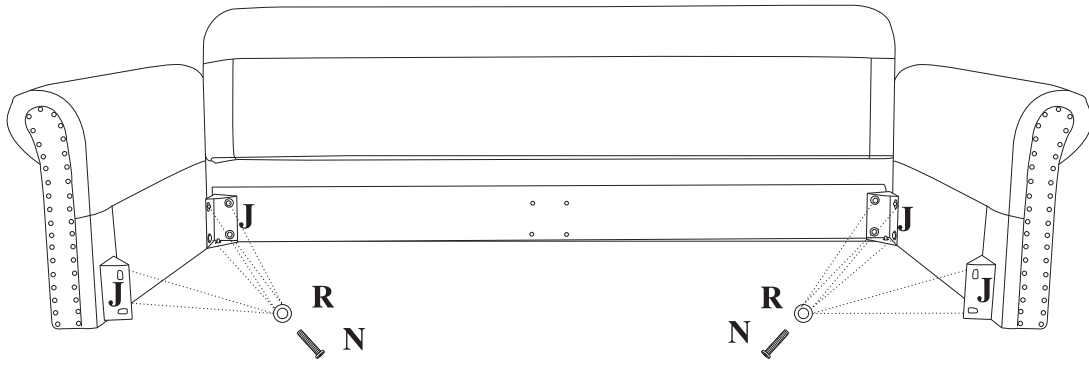

**STEP 5**

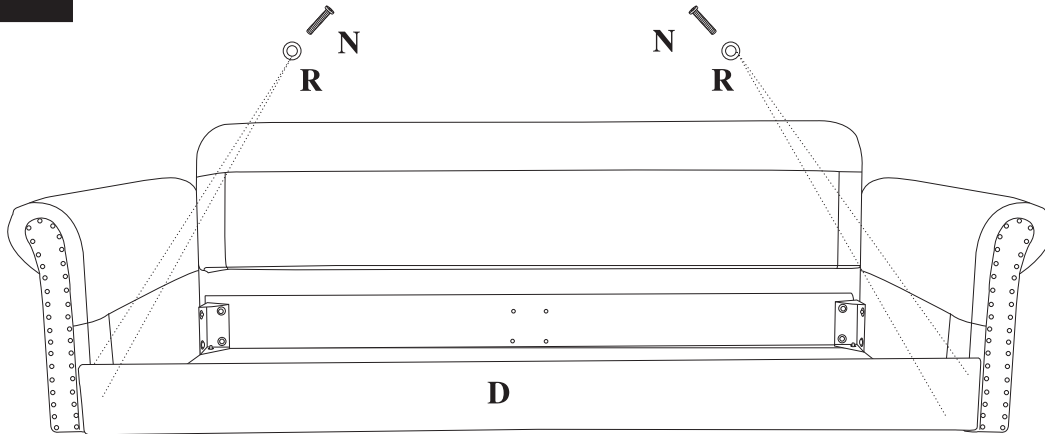

**STEP 6**

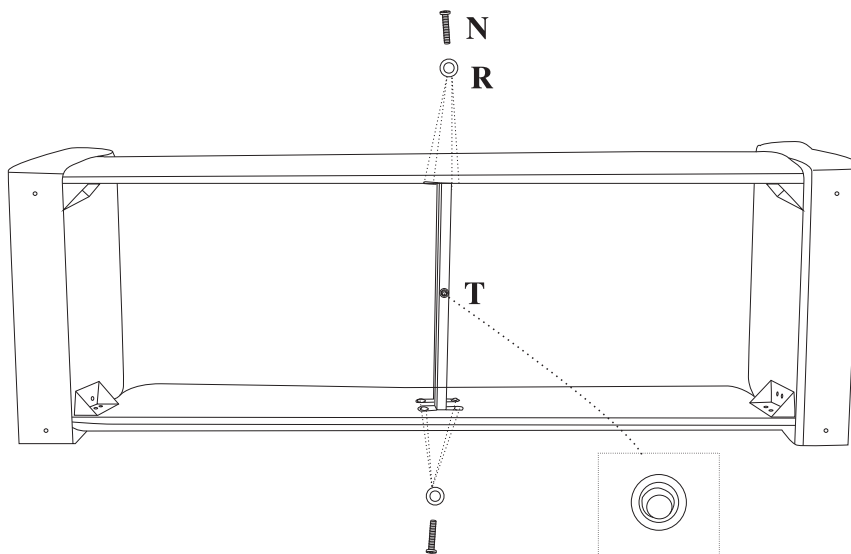

**STEP 7**

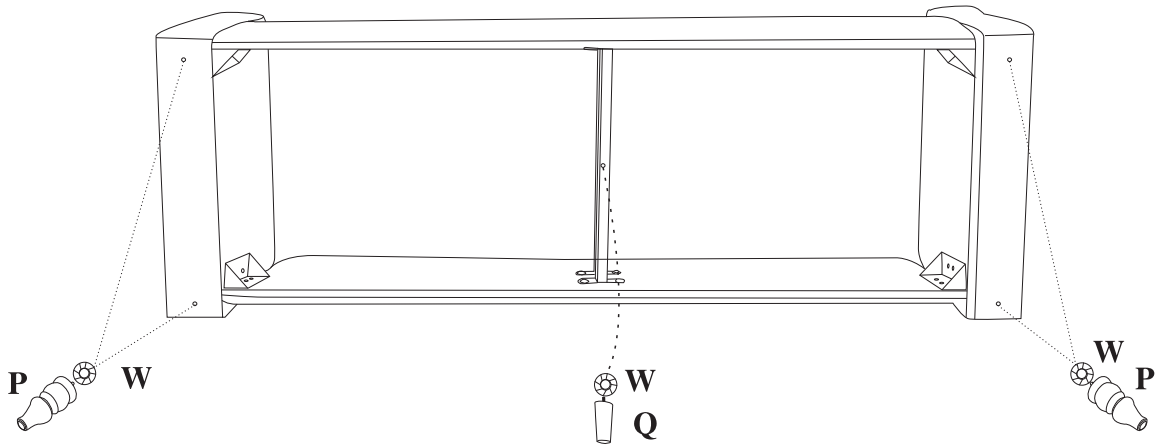

**STEP 8**

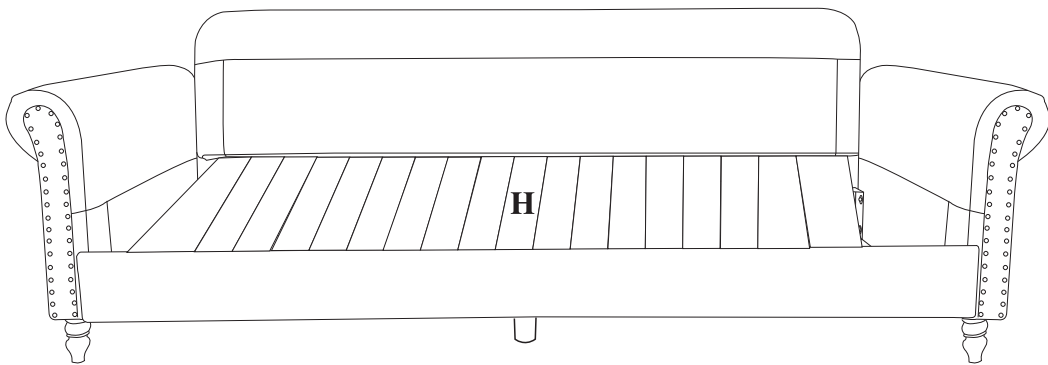

**STEP 9**

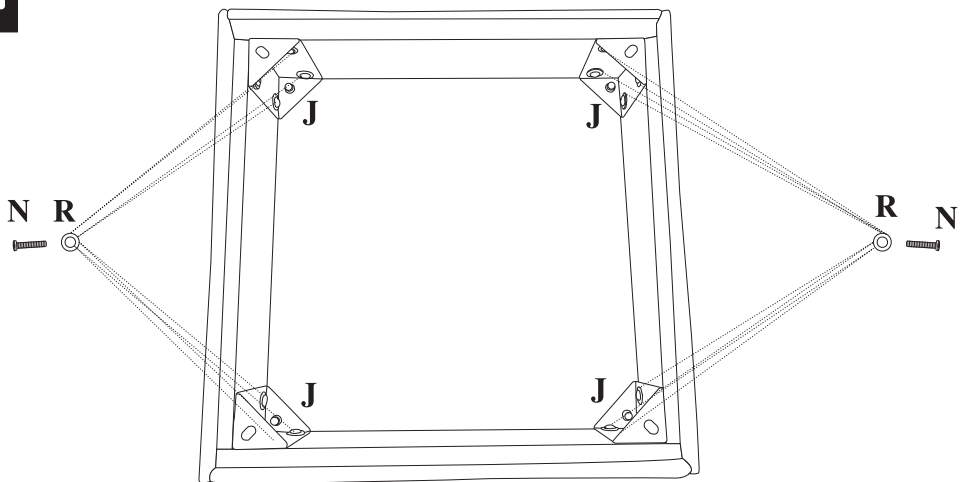

**STEP 10**

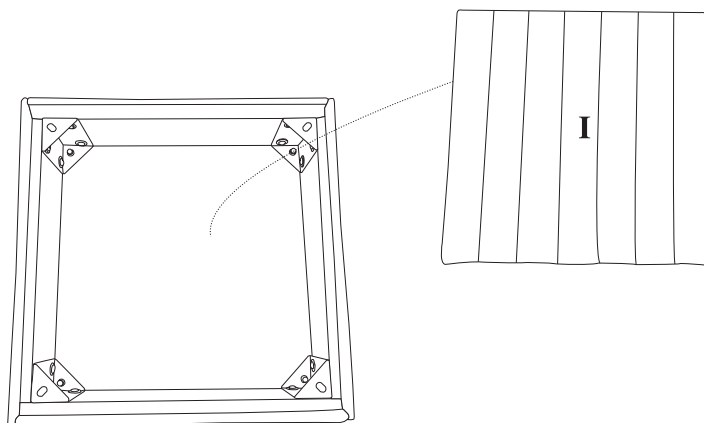

**STEP 11**

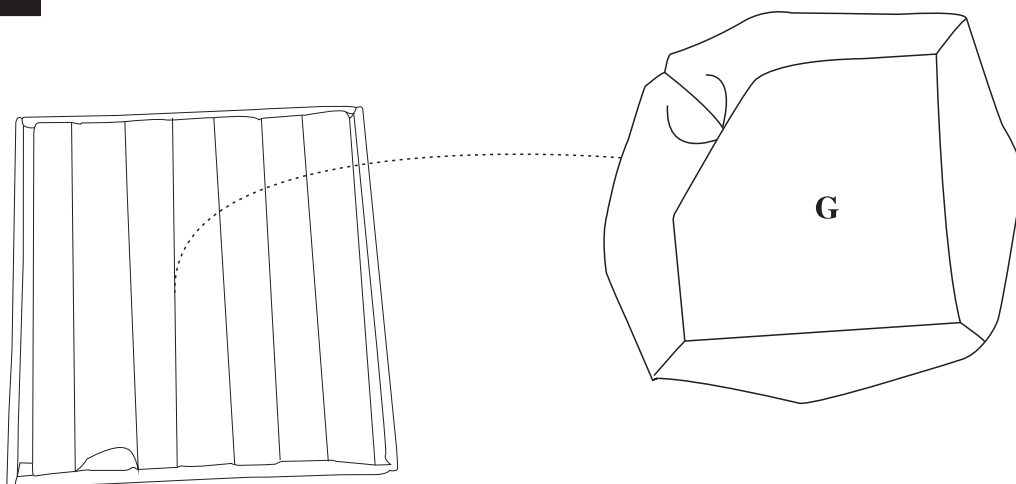

**STEP 12**

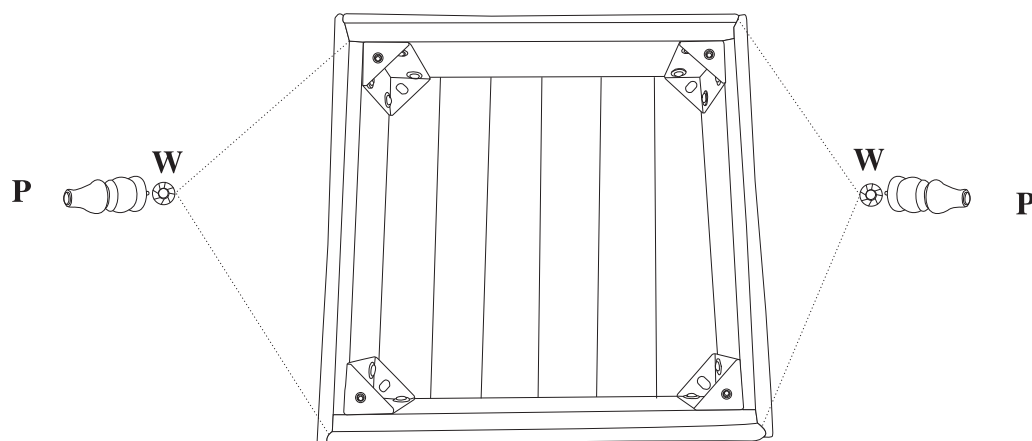

**STEP 13**

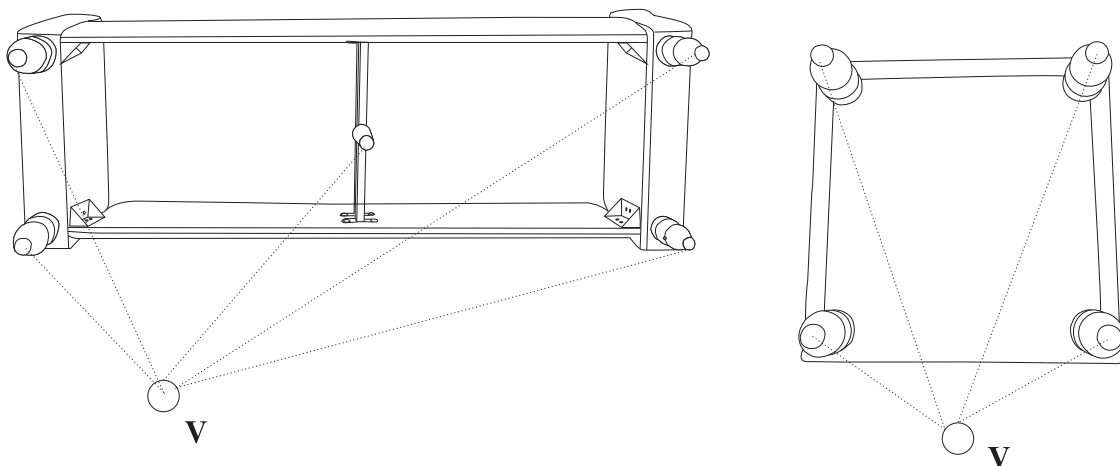

**STEP 14**

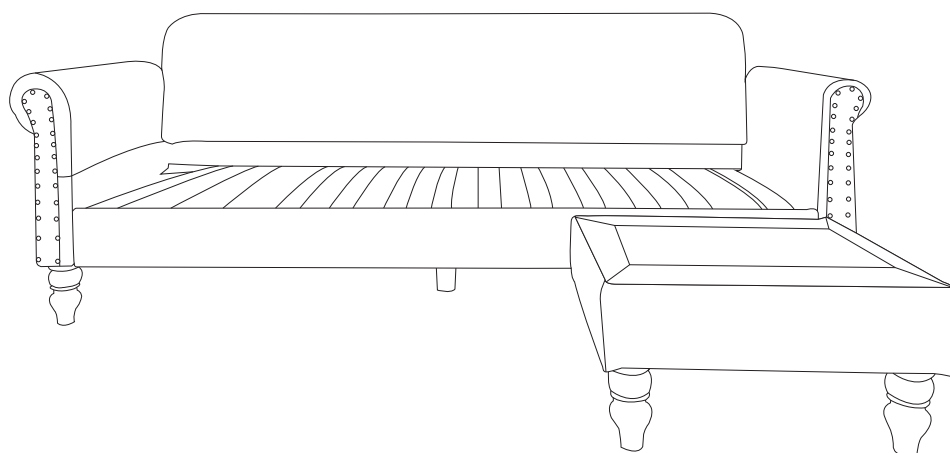

**STEP 15**

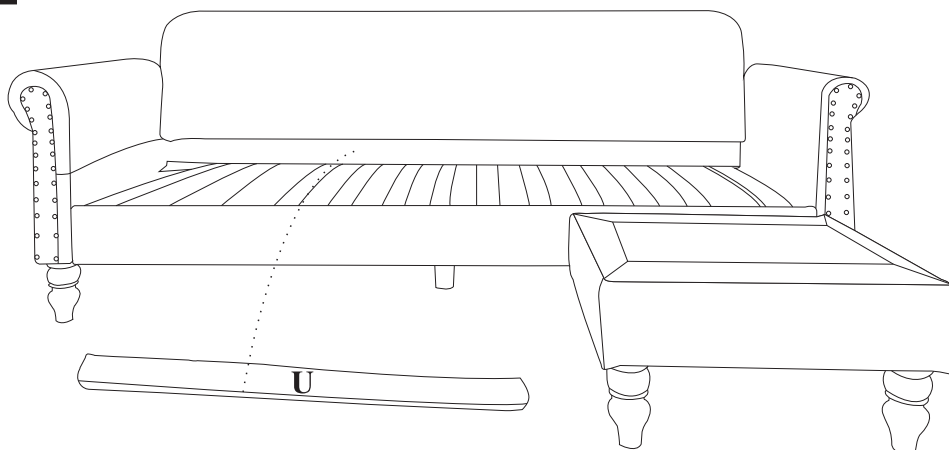

**STEP 16**

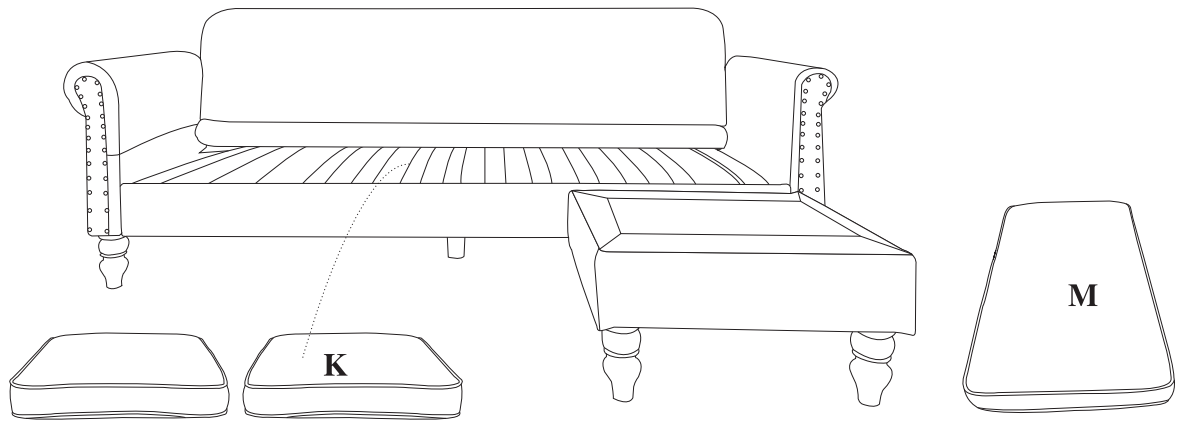

**STEP 17**

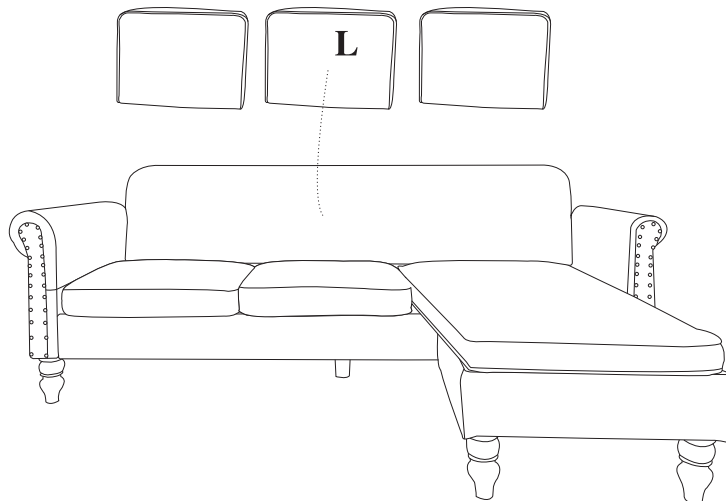

**STEP 18**

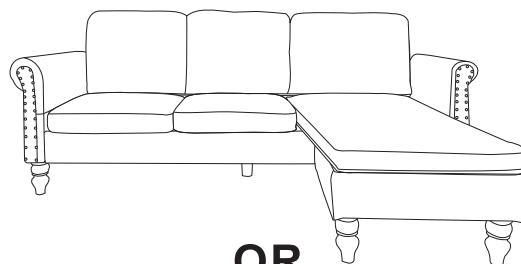

**OR**

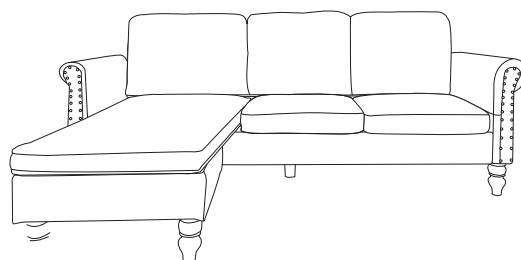

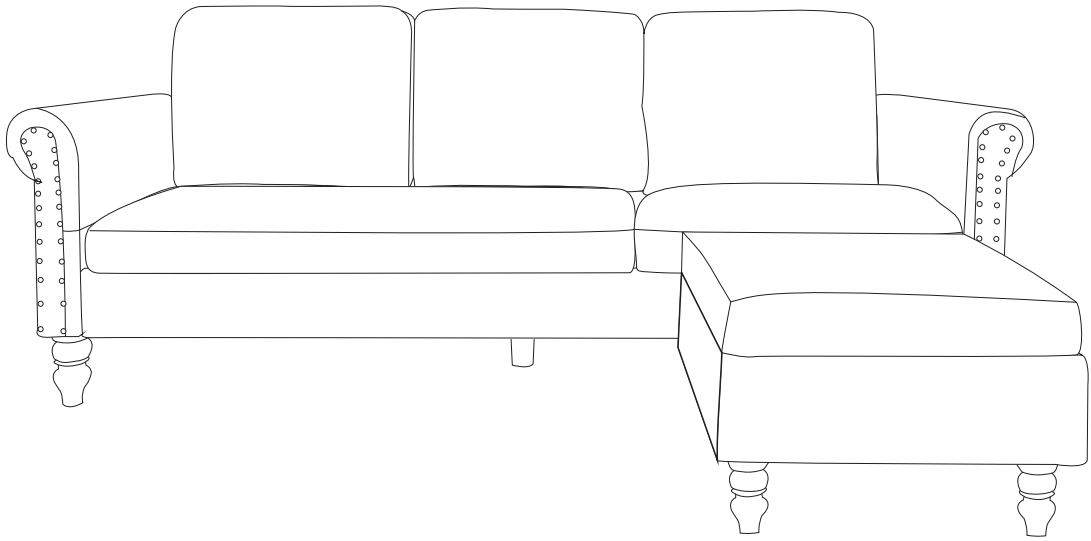
**STEP 19****ATTENTION:**

1. Please check the manual carefully and make sure you have received all the parts.
2. If there is any missing, please let us know the letter of the parts you need.
3. If there is any damage, please send clear photos to us, we will check and offer you best solution soon.