

# Living Room Furniture

Convertible Sofa Bed

Memory Foam Sofa

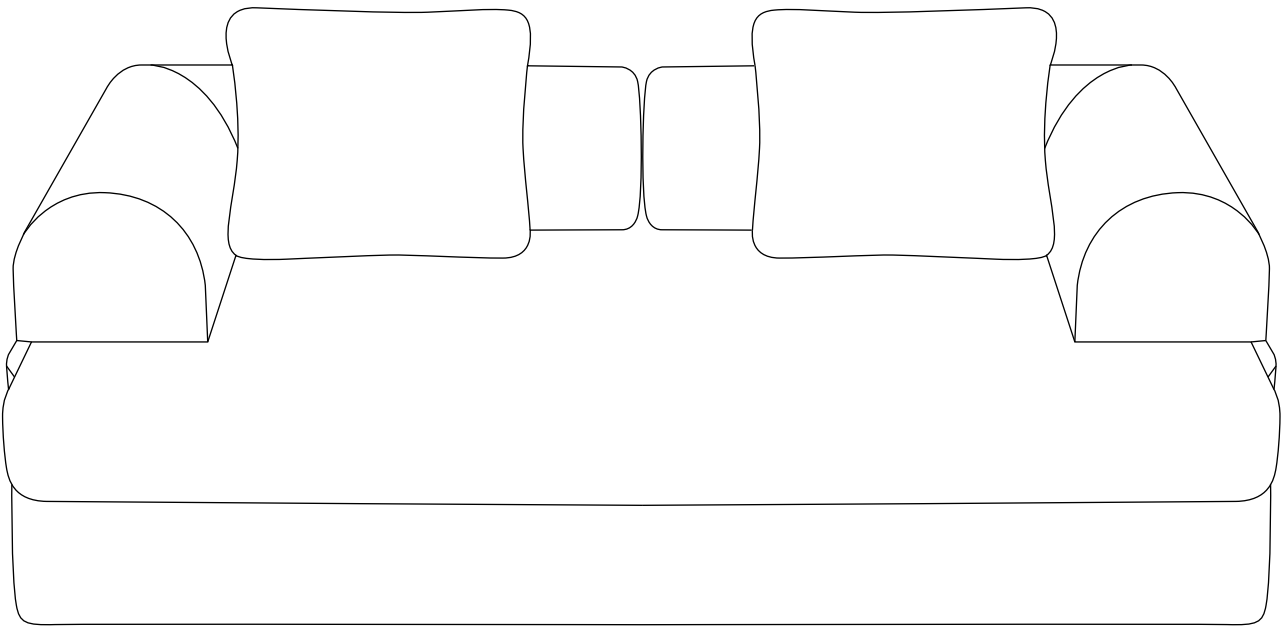

## **ATTENTION**

1. The product must be assembled and used according to the manual. The seller is not liable for any damage caused by incorrect assembly or misuse.
2. Do not sit or stand on the product.
3. Place the item on a flat surface.
4. Keep small parts away from children to avoid choking hazards.
5. Keep product away from corrosive gases, liquids and dusty environment.
6. Keep the original box(es) until assembly is complete or no quality issues need to be confirmed.

## **AFTER-SALE SERVICE**

If you have any suggestions or encounter quality issues with our products, please contact us first. Our after-sales team will respond within 24 hours, and we will do our best to provide a solution until you are satisfied.







## **GUARANTEED CUSTOMER SERVICE**

Your shopping experience is very important to us!

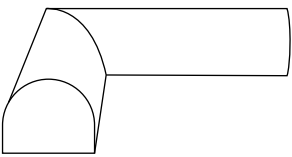
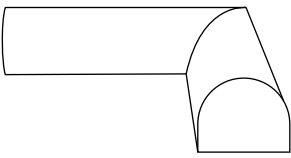
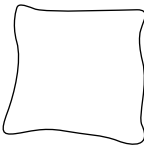
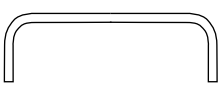
If you feel unsatisfied or have any questions, just contact us without any hesitation!

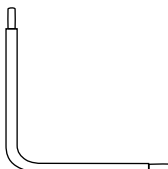
If you want to share how wonderful our smart product makes your home, you can share your pictures with us!

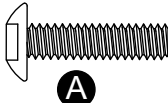
# PACKING LIST

|   |   |  |
|---|---|--|
| <p>1.</p>  <p>Cushion(1PC)</p>   | <p>2.</p>  <p>Left Armrest and backrest(1PC)</p>      |  |
| <p>3.</p>  <p>Right Armrest and backrest(1PC)</p>  | <p>4.</p>  <p>Pillows(2PCS)</p>                      |  |
| <p>5.</p>  <p>U-Bracket(4PCS)</p>  | <p>6.</p>  <p>U-Bracket(4PCS)</p>                      | <p>7.</p>  <p>L-Bracket(8PCS)</p> |
| <p>8.</p>  <p>Plastic box opener(1PC)</p>   | <p>9.</p>  <p>Iron Frame Fabric Slipcover(2PCS)</p> |  |
| <p>10.</p> <div style="display: flex; align-items: center; justify-content: space-around;"> <div style="border: 1px solid black; padding: 5px; text-align: center;">Fittings bag</div> <div style="font-size: 2em;">➔</div> <div style="text-align: center;">  <p><b>A</b></p> <p>Screws(16PCS)</p> </div> <div style="font-size: 2em;">+</div> <div style="text-align: center;">  <p><b>B</b></p> <p>Allen Key(1PC)</p> </div> </div> |   |  |

## ASSEMBLY INSTRUCTION

**STEP1.** Take all the parts out of the Paper box.  
Use the included plastic box opener to cut open the first package layer.

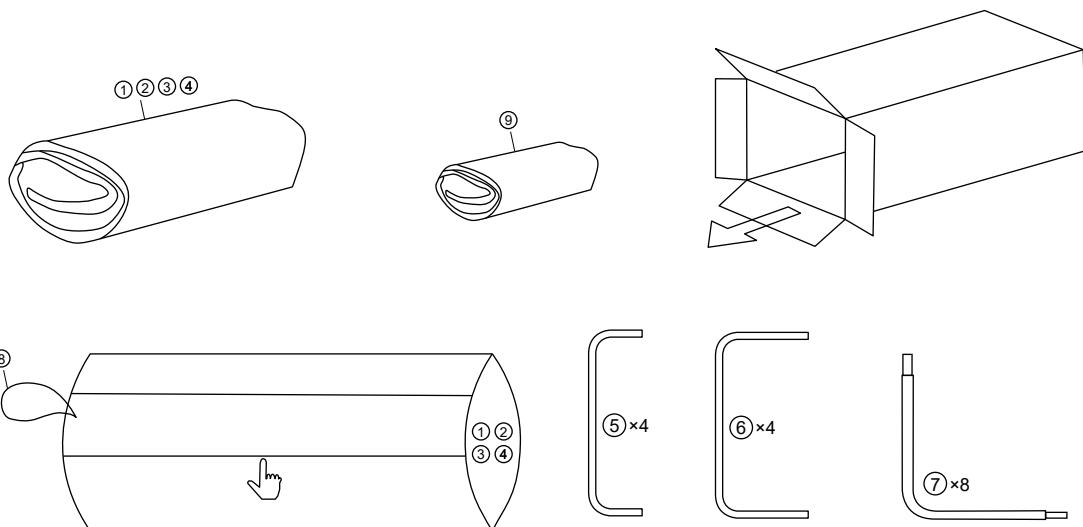

## ASSEMBLY INSTRUCTION

**STEP 2.** Use the box opener again to cut open the second package layer.  
Attention: The sofa will be released from the vacuum state and begin to inflate.  
Please ensure safety during this step to avoid injury from the expanding sofa.

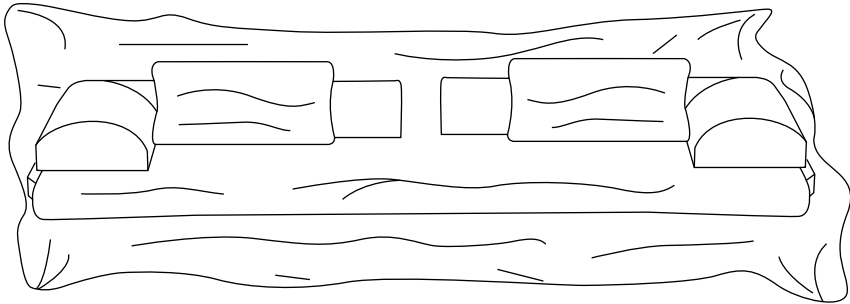

## ASSEMBLY INSTRUCTION

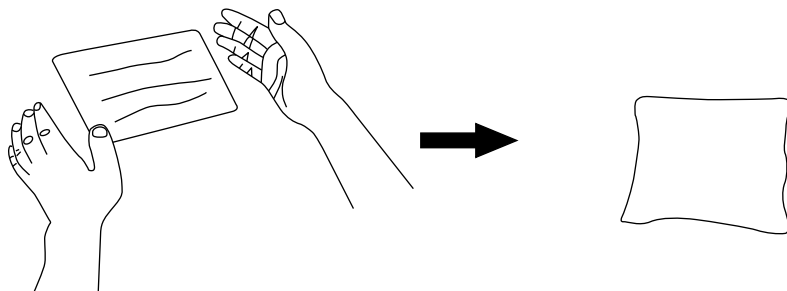

Fluff up the pillows for comfort.

## ASSEMBLY INSTRUCTION

**STEP3:** Use the box opener again to cut open the second package layer.  
Attention: The sofa will be released from the vacuum state and begin to inflate.  
Please ensure safety during this step to avoid injury from the expanding sofa.

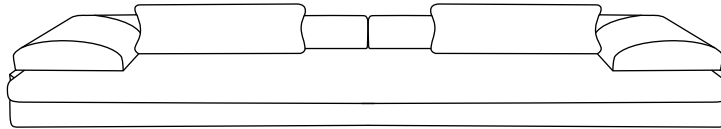

## ASSEMBLY INSTRUCTION

**STEP4:** After opening the package, leave the bean bag undisturbed for 72 hours to allow the foam to fully expand to its original shape.

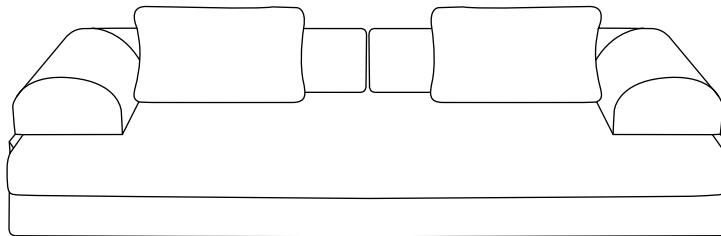



## ASSEMBLY INSTRUCTION

**STEP7:**Install the assembled iron frame onto the sides and back of the sofa.

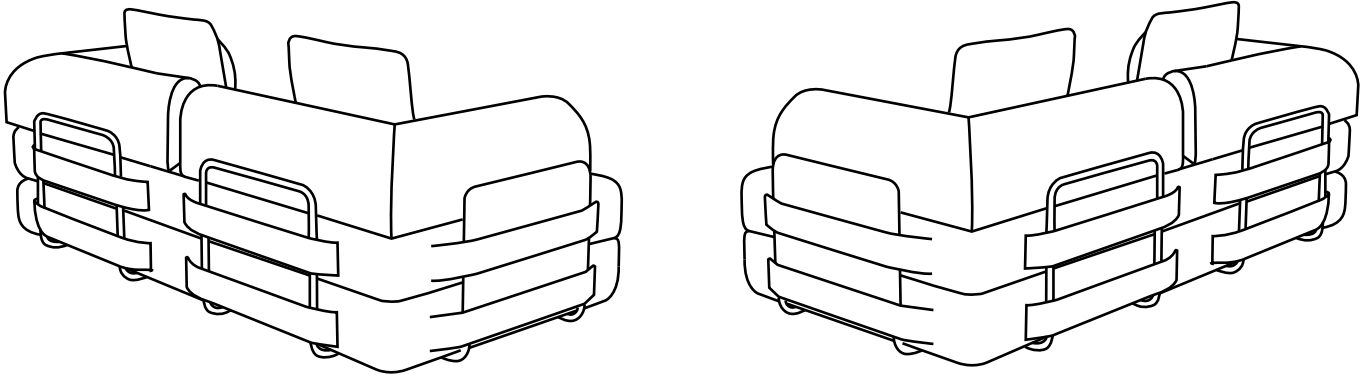

## ASSEMBLY INSTRUCTION

**STEP8:**Lazy sofa form.

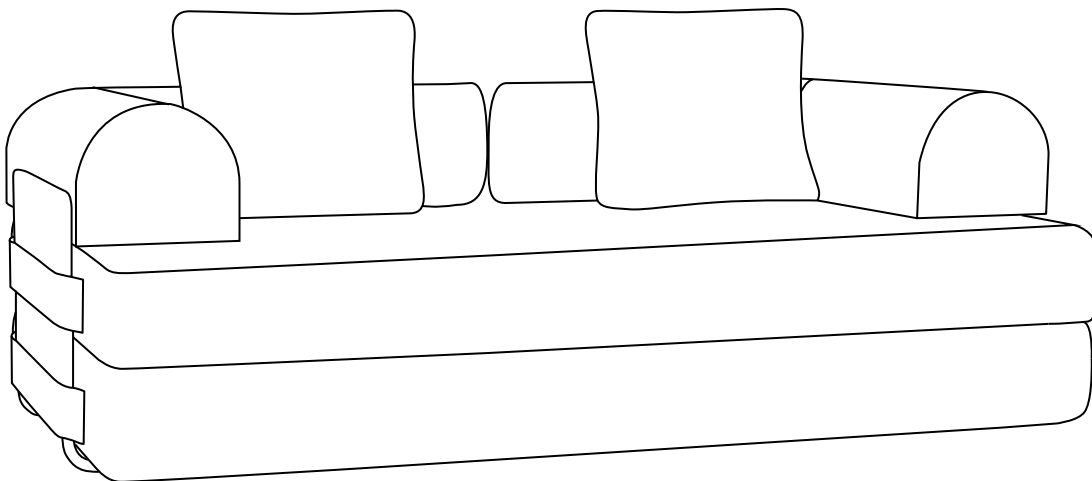

**COMPLETE!**

## ASSEMBLY INSTRUCTION

**STEP9:**The shape of the sofa when unfolded.

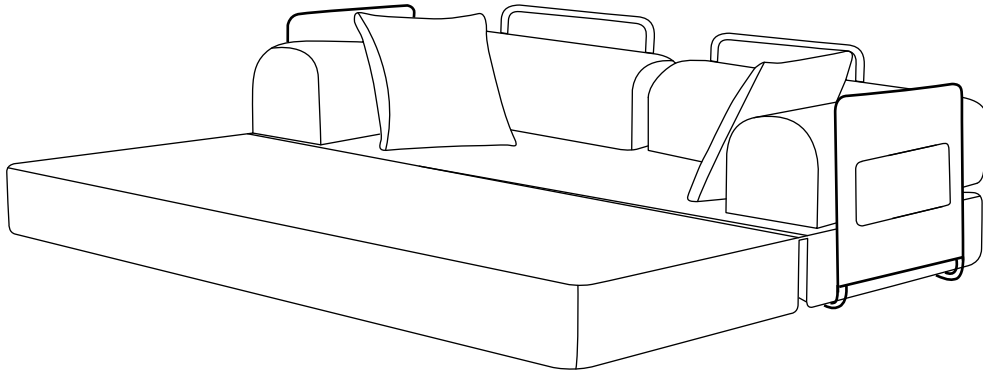

## ASSEMBLY INSTRUCTION

**STEP10:**The shape of the sofa when unfolded.

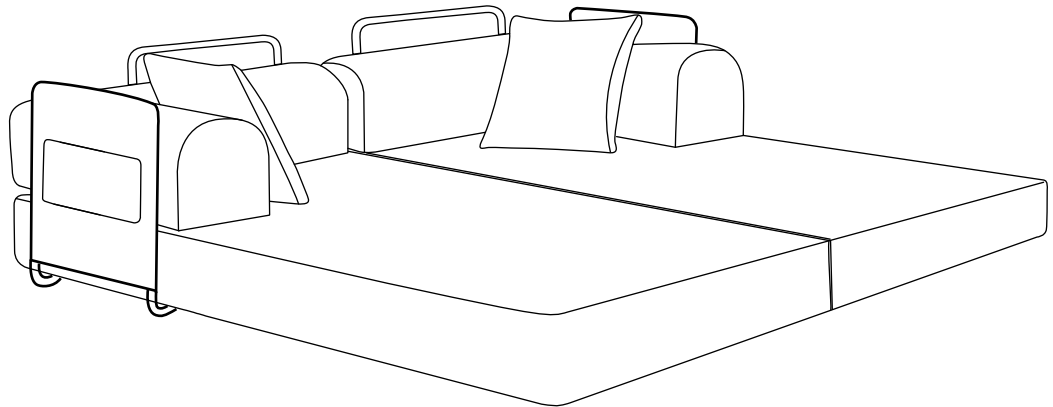

## Attention

When you find wrinkles on the sofa, you can use a steam electric iron (set to no more than 212°F) to smooth them out. Below is an example for reference.

