



**STELLA**

YEAR2020



DFM ATELIER

# UNIQUE HANDMADE PRODUCTION

DFM atelier is located in Milan (Italy) and bring know-how to each stage of the Stella lamp production. Detail-focused, artisanal production ensures that every creation is simple, sophisticated and exclusive. Each lamp is numbered and inventoried.

STELLA LIGHTING COLLECTION

# MID CENTURY DESIGN LEGACY

The Stella lighting collection is inspired by the work of famous mid century Italian designers, DFM is exploring the legacy of the past to create contemporary lighting.



STELLA COLLECTION

**LA PERFEZIONE**



# STELLA BABY

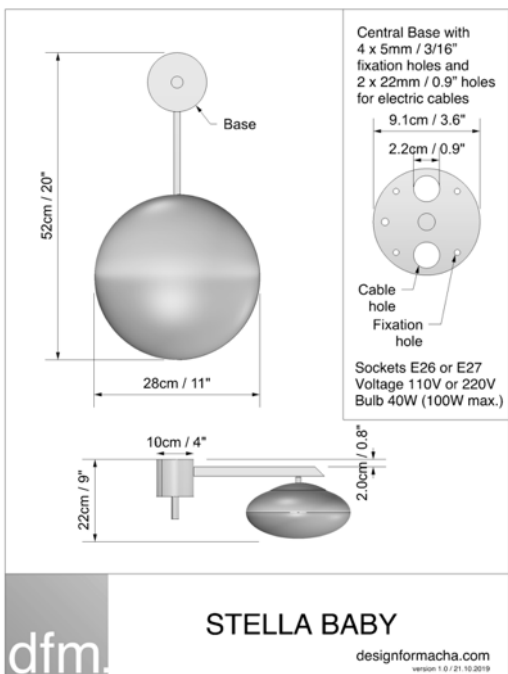

RECOMMENDED RETAIL PRICE  
2350 USD | 2200 EUR



# STELLA ANGEL

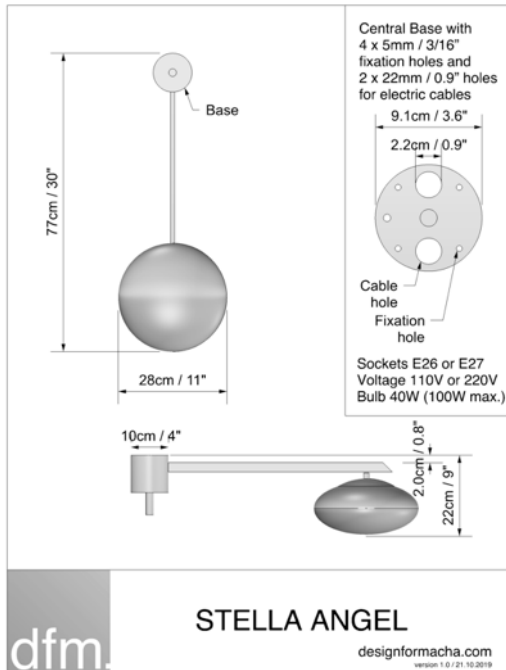

RECOMMENDED RETAIL PRICE  
2450 USD | 2100 EUR



# STELLA TOI&MOI

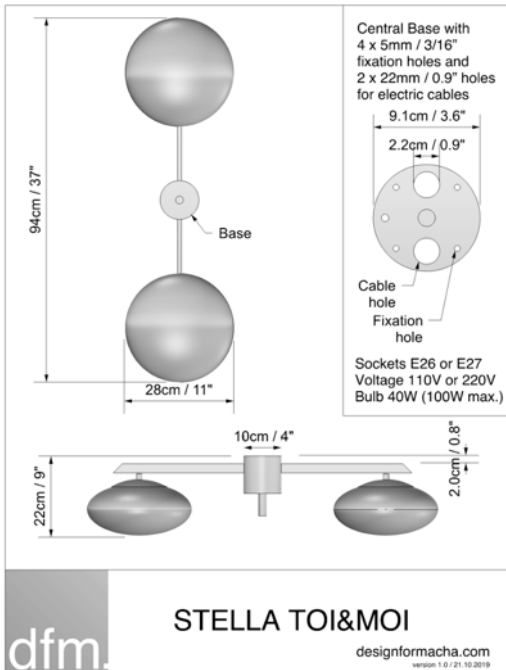

RECOMMENDED RETAIL PRICE  
3200 USD | 2700 EUR



# STELLA SNOOKER

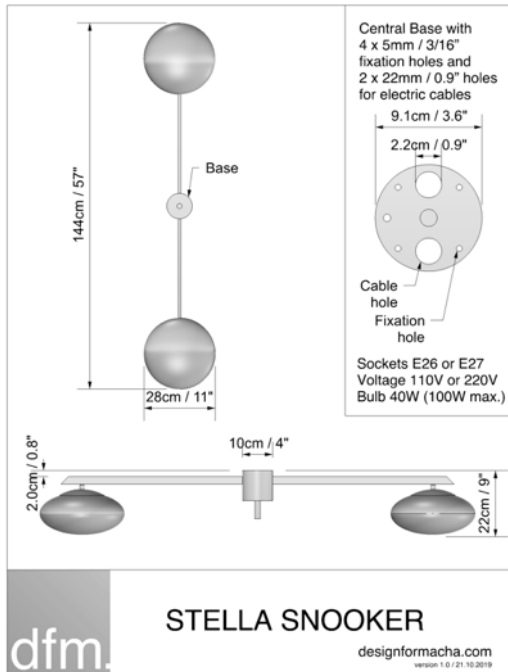

RECOMMENDED RETAIL PRICE  
3200 USD | 2700 EUR



# STELLA 12:15

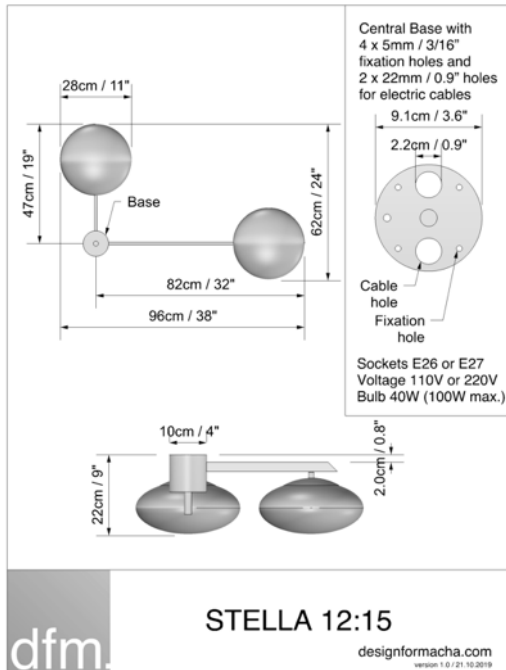

RECOMMENDED RETAIL PRICE  
3200 USD | 2700 EUR



# STELLA TRIENNALE

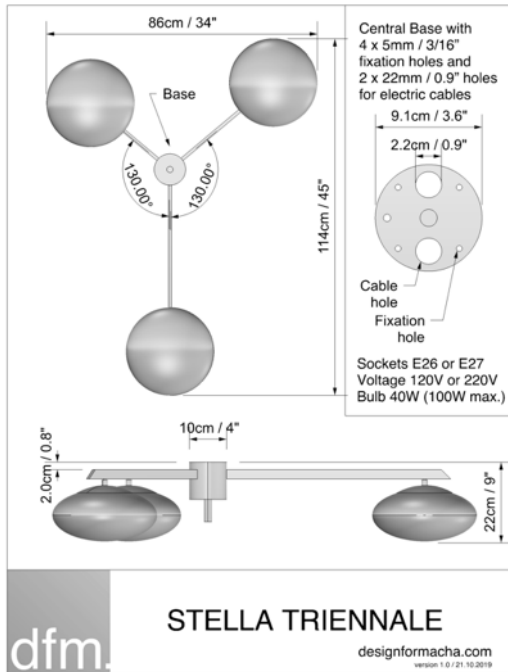

RECOMMENDED RETAIL PRICE  
4000 USD | 3400 EUR



# STELLA BUTTERFLY

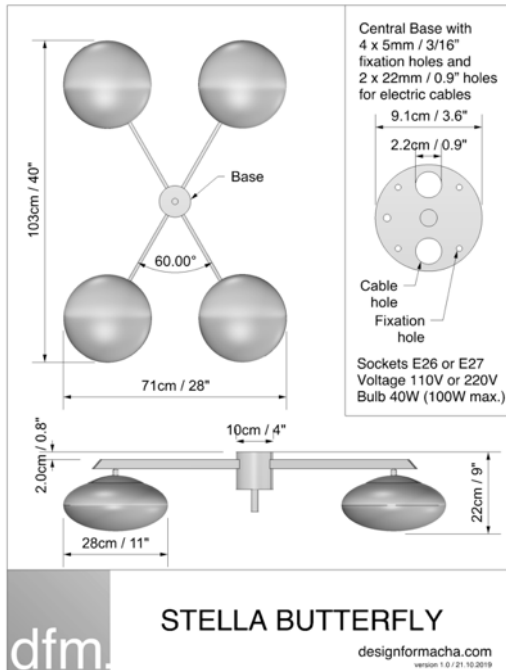

RECOMMENDED RETAIL PRICE  
4600 USD | 3900 EUR



# STELLA LOVE

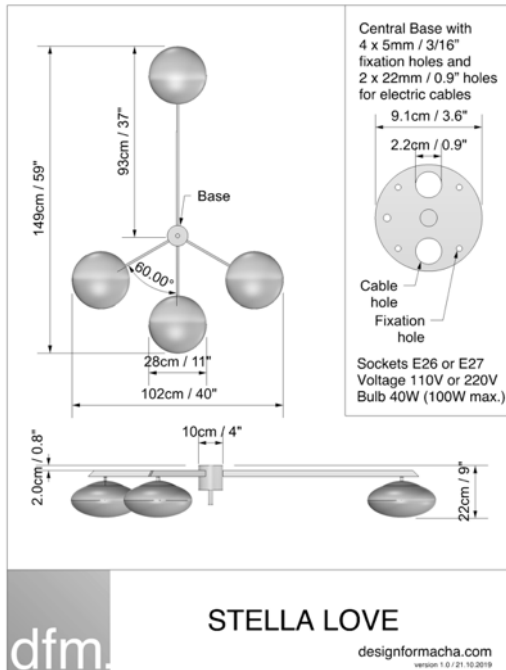

RECOMMENDED RETAIL PRICE  
4600 USD | 3900 EUR



# STELLA STARFISH

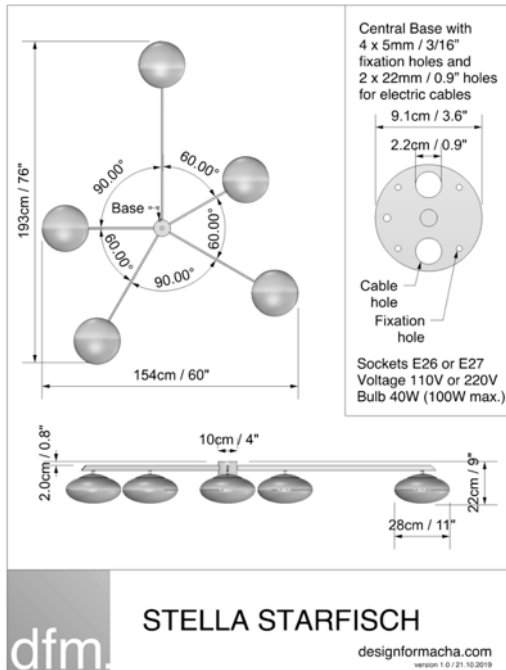

RECOMMENDED RETAIL PRICE  
 5400 USD | 4600 EUR



# STELLA DAISY

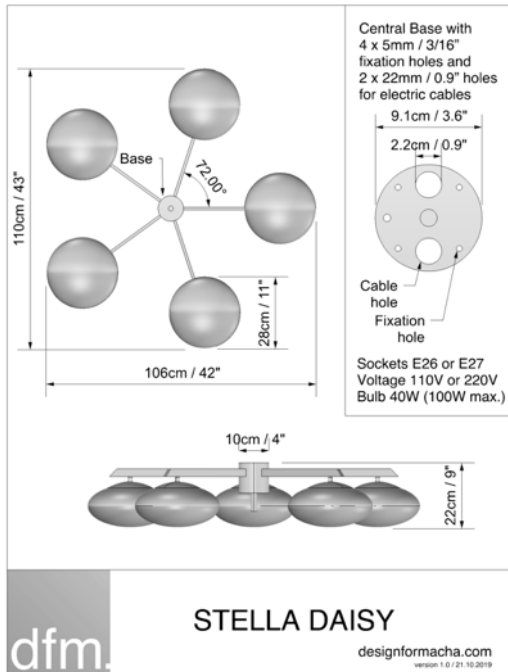

RECOMMENDED RETAIL PRICE  
5400 USD | 4600 EUR



# STELLA FAN

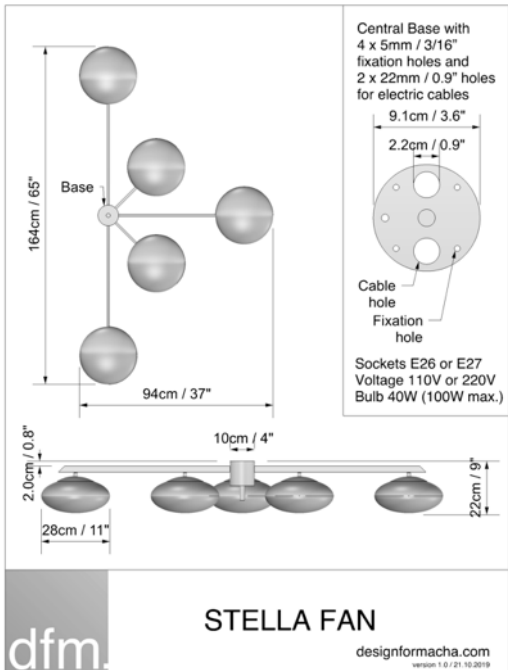

RECOMMENDED RETAIL PRICE  
5400 USD | 4600 EUR



# STELLA TRIBUTE

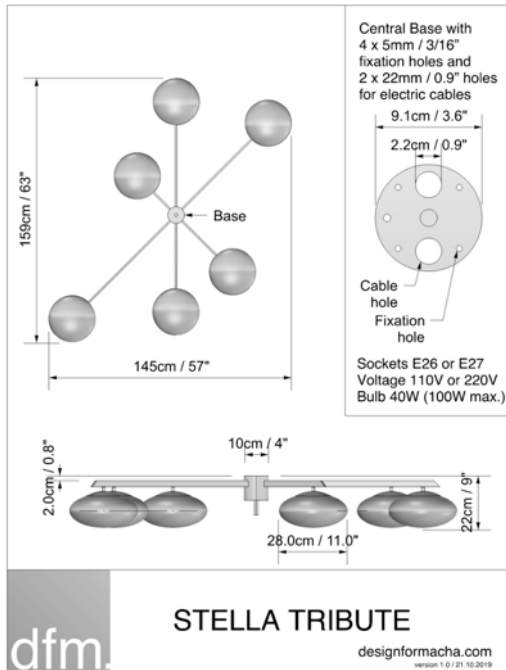

RECOMMENDED RETAIL PRICE  
6000 USD | 5100 EUR



# STELLA CANOPY

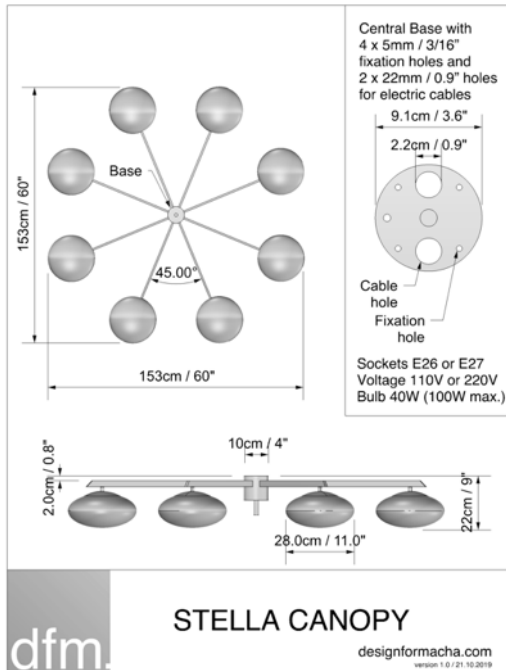

RECOMMENDED RETAIL PRICE  
6700 USD | 5700 EUR



# STELLA EVENING

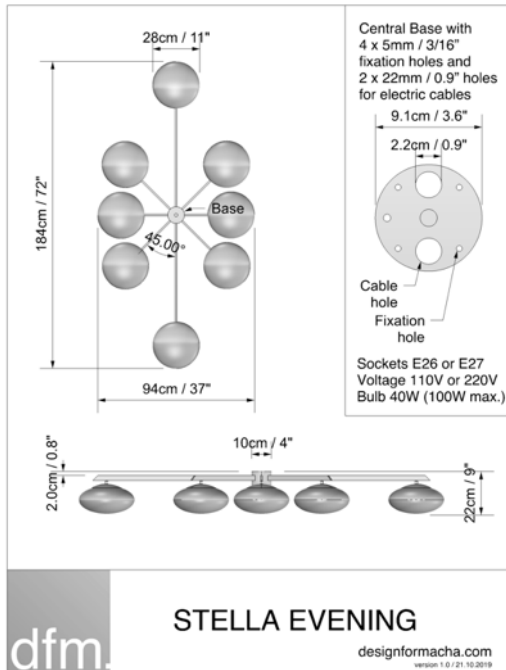

RECOMMENDED RETAIL PRICE  
6700 USD | 5700 EUR



# STELLA COSMOS

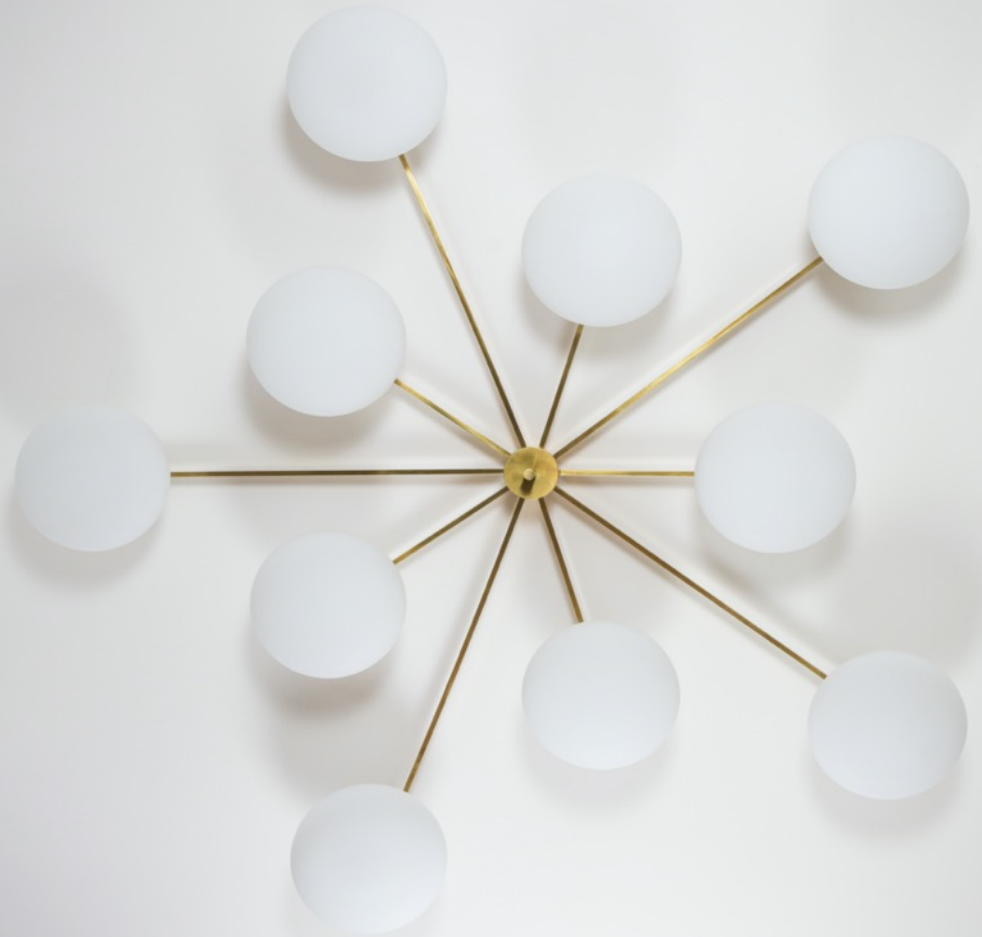
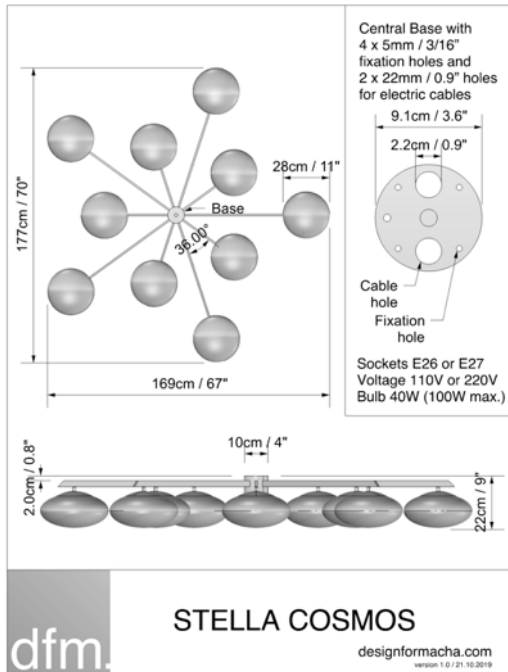

RECOMMENDED RETAIL PRICE  
7800 USD | 6600 EUR





STELLA COLLECTION  
**ITALIAN ART OF LIVING**



# MADE OF BRASS AND OPALINE FROM MURANO CAN BE MOUNTED AS A CELING OR WALL LAMP

## ELECTRIFICATION

Stella lighting can be wired based on your country requirement

	<b>US / CANADA</b> (all electric components used are UL listed)	<b>REST OF THE WORLD</b>
CABLE	100/120 V, 60Hz	220/240 V, 50Hz
BULBS	E 26 socket bulbs 100W maximum per bulb. Compatible with LED. Dimmable. Light bulbs not included.	E27 socket bulbs 100W maximum per bulb. Compatible with LED. Dimmable. Light bulbs not included.

## DIMENSIONS & CUSTOMOZIATION

We also offer the option to create your own Stella lamp configuration. Up to 12 globes and arms can be added to the central base. Please contact us to create a design that suits your interior at [sales@designformacha.com](mailto:sales@designformacha.com)

<b>CENTRAL CANOPY</b>	Two canopy diameters are available : 13 cm / 5 inches 10 cm / 4 inches
<b>GLOBE</b>	Made of brass and opaline from Murano Diameter : 22,5 cm / 9 inches
<b>ARM LENGHT including GLOBE</b>	35 cm / 14 inches 45 cm / 18 inches 50 cm / 20 inches 60 cm / 24 inches 75 cm / 30 inches 80 cm / 32 inches 100 cm / 39 inches
<b>NUMBER OF ARM</b>	From 0 to 12

STELLA COLLECTON  
**CONFIGURATION** 

Brass is timeless and at the heart of the design trend. DFM has developed strong expertise in terms of manufacturing and treatment to get incredible patinas.



Chromed  
Lucid



Chromed  
Opaque



Polished  
Brushed



Polished



Unolished  
Lucid



Unolished  
Opaque



Unolished  
Balanced



Bronze



Blackened



Brass can be also painted using the same techniques used by automotive industry. You just have to choose from the RAL colour standard.



STELLA COLLECTON  
**LOVES BRASS** 

# STEM

A **BRASS ROD** to lower the lamp is available. Height is to be defined based on your requirements until 100 inches (250 cm) from the ceiling.

Thanks to the brass rod – arms can be positioned globes facing up or facing down.



# BE INSPIRED

Please contact us to create a design that suits your interior at [sales@designformacha.com](mailto:sales@designformacha.com)



STELLA COLLECTON

**OPTIONS** 

# ASSEMBLY & MAINTENANCE

Assembly instructions are included. Set-up takes about 20 minutes. Installation should be carried out by a qualified electrician.

# SHIPPING

Orders are insured and shipped in a custom protective box by Express DHL. Worldwide shipping. Lightings are picked up within **five days** after an order is confirmed. A tracking number will be provided when as soon as your order is shipped from our Atelier.

# WARRANTY

A five-year warranty manufacturing defects and wiring is applicable. After-sales service is available.

Kindly contact: [sales@designformacha.com](mailto:sales@designformacha.com)





**DFM | SALES**

Rue de la rotisserie 2, 1204 Geneva (Switzerland)  
+41 78 928 11 33

**DFM | ATELIER**

Via Astura 5, 21041 Milan (Italy)

[www.designformacha.com](http://www.designformacha.com)  
[sales@designformacha.com](mailto:sales@designformacha.com)  
Instagram : @designformacha

**DFM | DESIGNforMACHA**

DFM merges the boundaries between art, design and architecture. DFM is dedicated to the production of contemporary lighting by mid-20th century design, fusing high end European craftsmanship with renowned Swiss quality and reliability. Detail-focused, artisanal production ensures that every creation is simple, sophisticated and exclusive.

