

Assembly Instructions

Caution : You must read this before you proceed

COFFEE TABLE

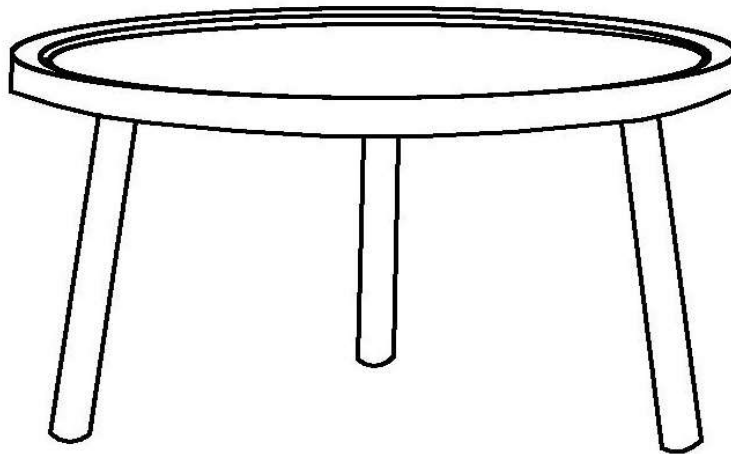

Parts List

Label	Picture	Description	QTY
A	A circular diagram representing the table top. It contains three small rectangular holes, each with two dots, arranged in a triangle. These represent the locations where the legs will be attached.	Top	1
B	A perspective drawing of a single cylindrical leg. It has a small circular detail at one end, likely representing a mounting hole or a decorative cap.	Round Leg	3

Assembly Preparation

Before
Beginning
Assembly:

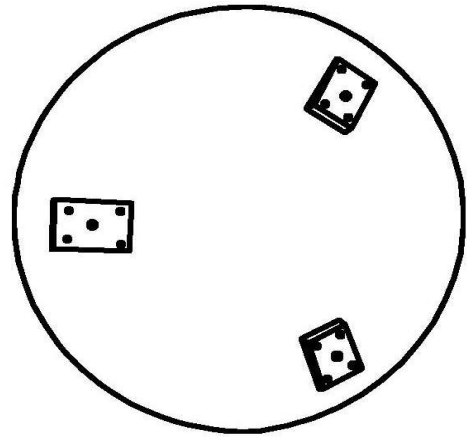
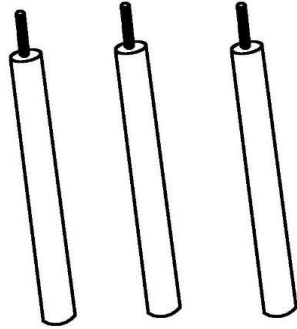

- Read instructions, cover to cover-



- Have 2 adults on hand for assembly-



- Do not assemble on flooring or carpet-



- Assemble on a clean non-marring surface (packing foam)-



- Save all packaging until finished-

Assembly Steps

Overview

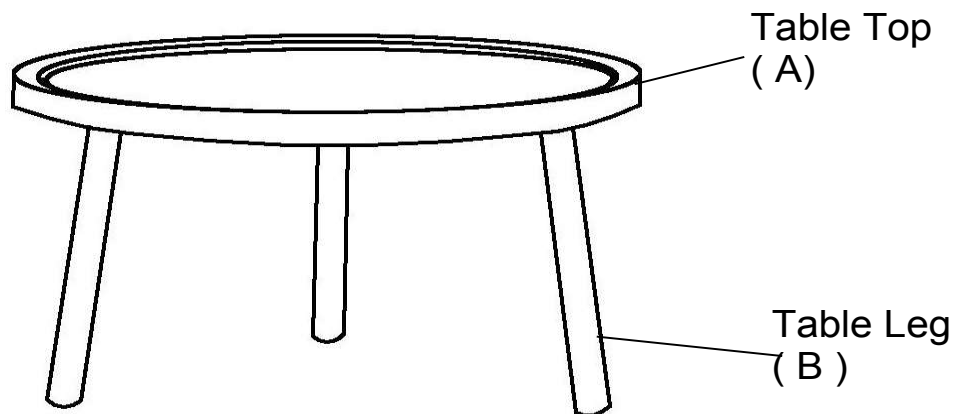

This Coffee table has multiple parts and may require up to some 30 minutes to assemble. To give you an overview of the table parts, the above picture is to help you put the various parts into perspective. Please read through the instructions below to familiarise yourself with the parts and steps before assembly.

Step 1

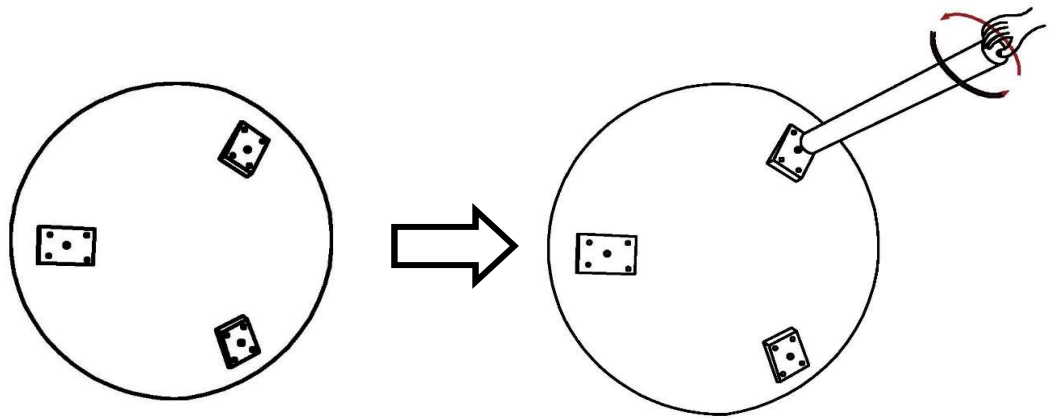

With assistance from your adult partner, place the Table Top (A) face down as picture, on clean, non-marring surface. As shown in “Step 1” picture tighten the Leg (B) stud to slot given in Table top (A).

Step 2

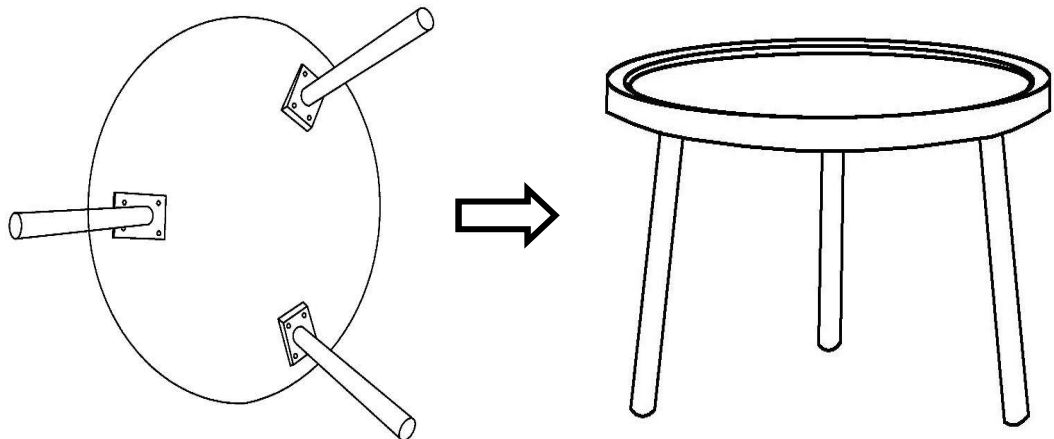





















Repeat “Step 1” to assemble all the other two Legs (B) to Table Top (A). Upon assembly of all the Legs, flip the Coffee Table as shown in “Step 2”.

This Coffee Table is now ready to use.

Caution: This Coffee Table can only be used on flat, level surface

Care & Maintenance

-   ● Do not put hot items directly on furniture surface.
 -   ● Do not clean furniture with harsh cleansers or polish.
 -   ● Do not place furniture under direct sunlight.
 -   ● Do not place furniture near heating or cooling vents.
 -   ● Do not write on furniture without a padded barrier to protect the surface.
 -   ● Do not place furniture outside. For indoor use only.
 -   ● Not for commercial use. For residential use only.
 -   ● Stains may be removed with mild soap solution and damp cloth.
 -   ● Children should not climb or jump on the furniture.
-
-   ● Dust and pick-up spills using a clean, non-colored, lint-free cloth.