

Owner Manual

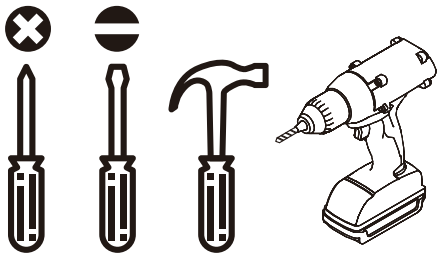

Tools required
(not included)

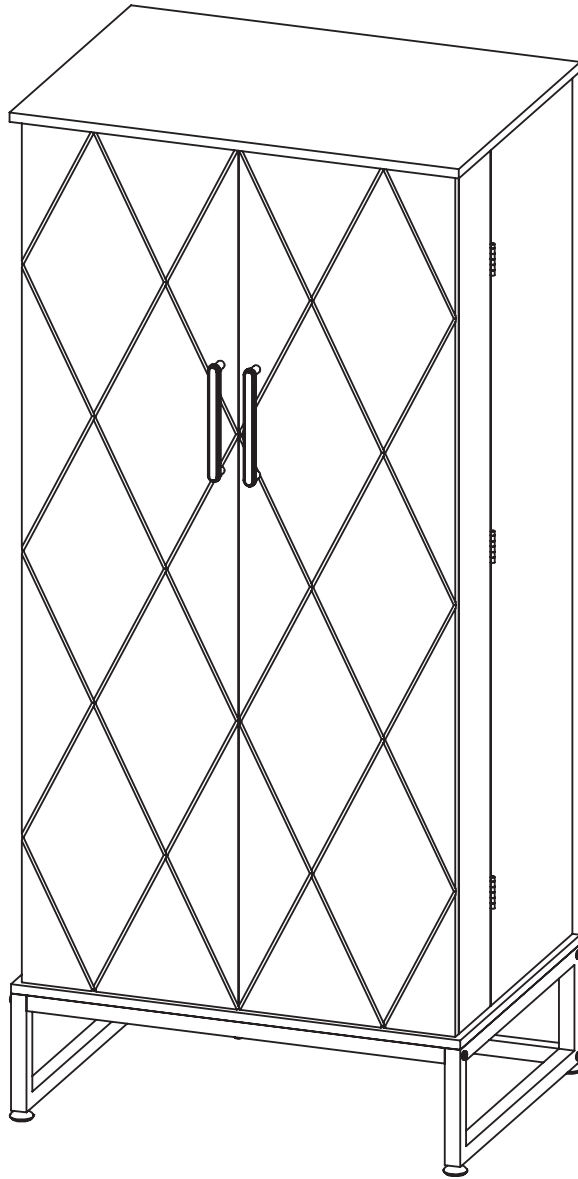
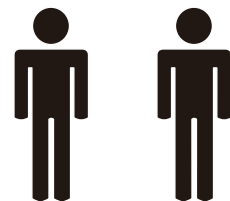

2 people for assembly



Safety and Care Advice

Important – Please read these instructions fully before starting assembly

- Check you have all the components and tools listed on the following pages.
- Remove all fittings from the plastic bags and separate them into their groups.
- Keep children and animals away from the work area, small parts could choke if swallowed.
- Make sure you have enough space to layout the parts before starting.

- During assembly do not stand or put weight on the product, this could cause damage.
- Assemble the item as close to its final position (in the same room) as possible.
- Assemble on a soft level surface to avoid damaging the unit or your floor.
- Parts of the assembly will be easier with 2 people.



- To reduce the likelihood of damaging your product please ensure that your power drill is set on a low torque setting.

Care and maintenance

- Only clean using a damp cloth and mild detergent, do not use bleach or abrasive cleaners.
- From time to time check that there are no loose screws on this unit.
- This product should not be discarded with household waste. Take to your local authority waste disposal centre.

Handy Hints

- Assemble all parts and bolts loosely during assembly, only once the product is complete should you fully tighten the bolts
- Regularly check and ensure That all bolts and fittings are tightened properly.

WARNING In order to help prevent overturning – please follow these instructions

To help prevent product toppling over please follow the below steps:-

Use the anti tip stap or wall fixing method provided (if applicable)
Do not allow children to climb or hang on the furniture
Do not open more than one drawer at a time
Do not place heavy items in the top drawers
Do not place heavy items on top of the furniture, unless the furniture has been designed for this purpose

please note that only the anti tip strap is provided.

You will need to provide wall plugs and screws applicable for your wall type

Using Camlocks

Step 1

Connect the male camlock as directed in the assembly instructions using a screwdriver.

1

DO NOT OVER TIGHTEN.
NE PAS SERRER EXCESSIVEMENT.

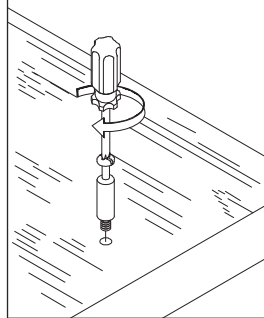

Step 2

Push the male camlock into the entry hole.

2

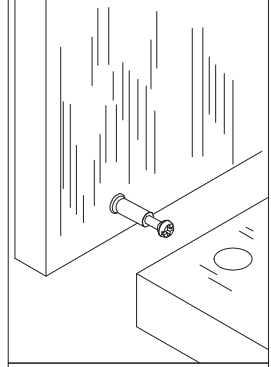

Step 3

Insert the female camlock as shown in the instruction.

Note: ensure that the arrow on the top of the camlock points towards the entry hole for the male camlock.

3

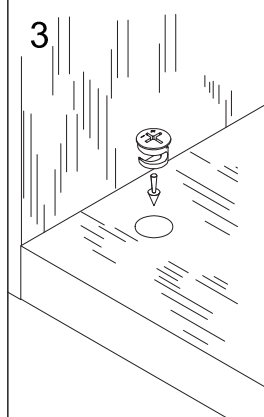

Step 4

Turn the female camlock clockwise with a screwdriver.

You should feel a click when the camlock is locked in place.

The joint is now secure.

4

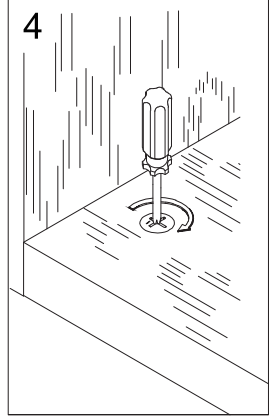

WARNING



Children have died from furniture tipover. To reduce the risk of furniture tipover:

- ALWAYS install tipover restraint provided.
- NEVER put a TV on this product.
- NEVER allow children to stand, climb or hang on drawers, doors, or shelves.
- NEVER open more than one drawer at a time.
- Place heaviest items in the lowest drawers.



This is a permanent label.
Do not remove!

Important Notice:

If you encounter any issues with the product, we kindly request you to promptly contact the customer service of the store. Specifically, if you need to initiate a product return, please reach out to the customer service for assistance. We are dedicated to prioritizing your needs and will efficiently process refunds or arrange for reshipments as necessary. It is important to note that selecting the return address provided on the backend may not be suitable for receiving returns, so we advise against using it directly.

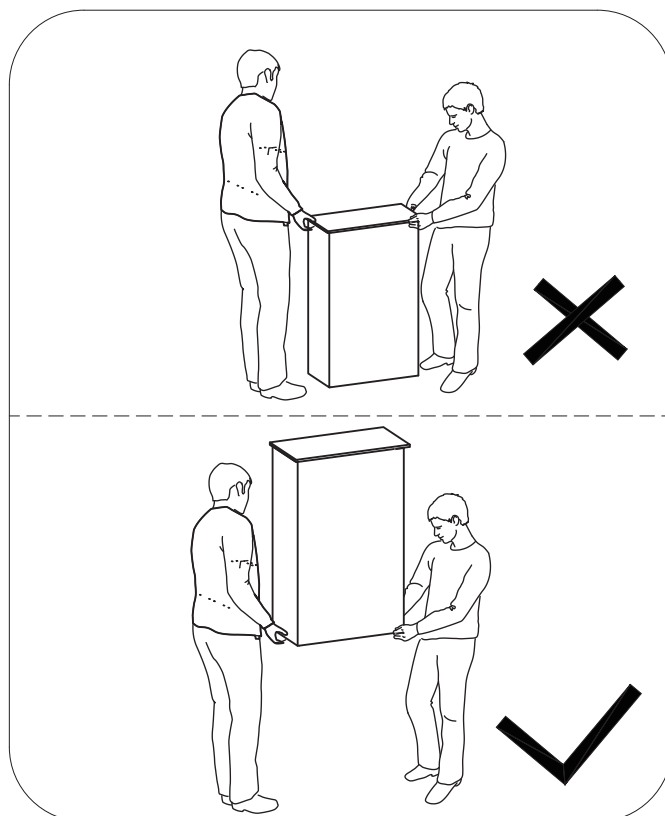

Safety warning for furniture use

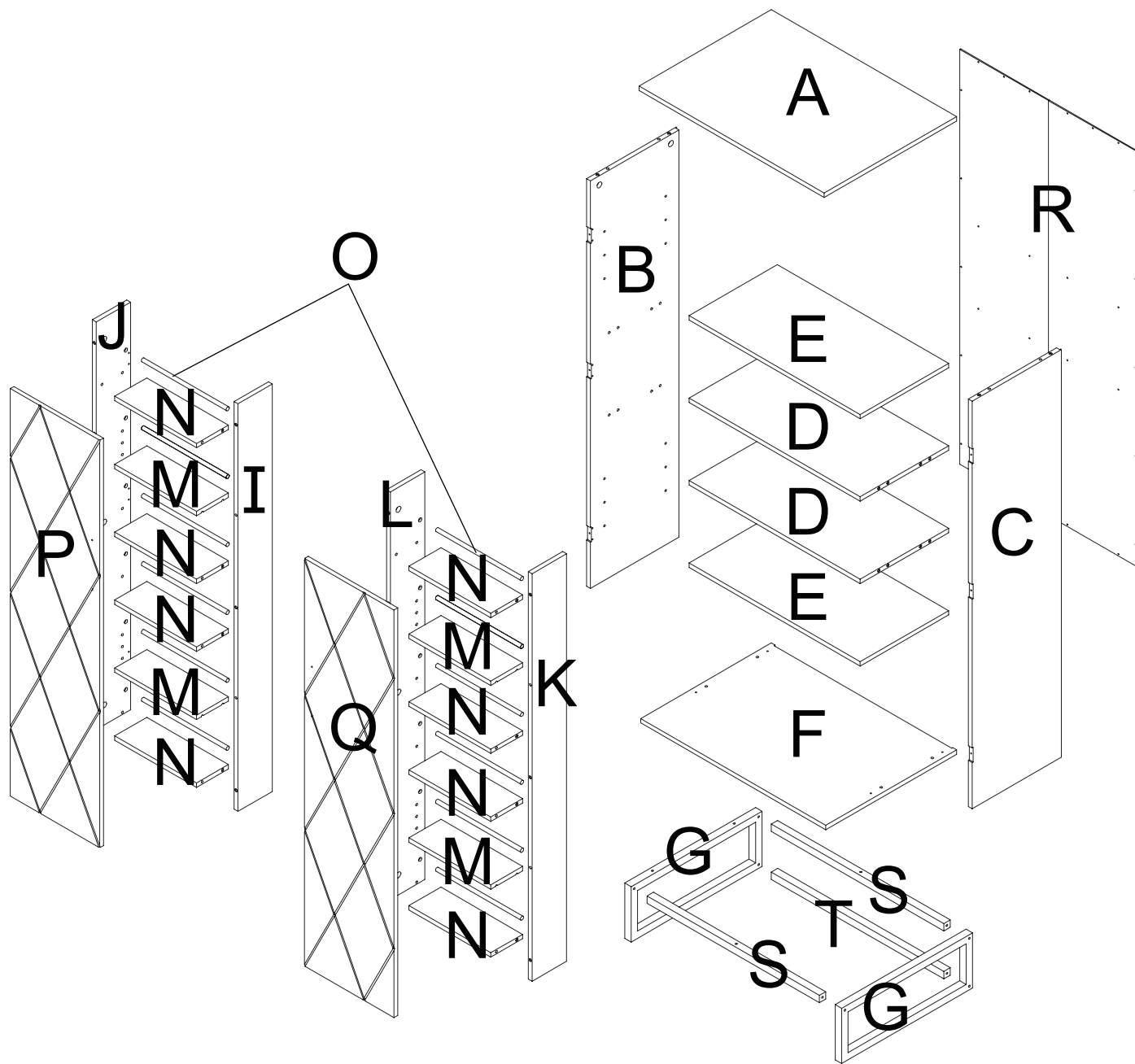

1. If you want to move the furniture, the furniture should be moved, not dragged, carefully put gently, to prevent the impact of sharp tools and hard objects.
2. when moving cabinet frame furniture, should move out of the cabinet object, door, drawer seal or take out the drawer directly, lest furniture tilt, parts slide hurt, even damage.
3. when moving, avoid hard and drag, so as to avoid loose foot plate and tenon, furniture must be lifted a little slowly move.
4. tables and chairs can not be lifted the surface, easy to fall off, should be lifted from both sides of the table and the chair face, the cabinet had better unload the cabinet door and lift, can reduce the weight, but also avoid the cabinet door activity. If you need to move the particularly heavy furniture, you can use a soft rope into the furniture chassis to move again.

PRODUCT ASSEMBLY



PRODUCT ASSEMBLY

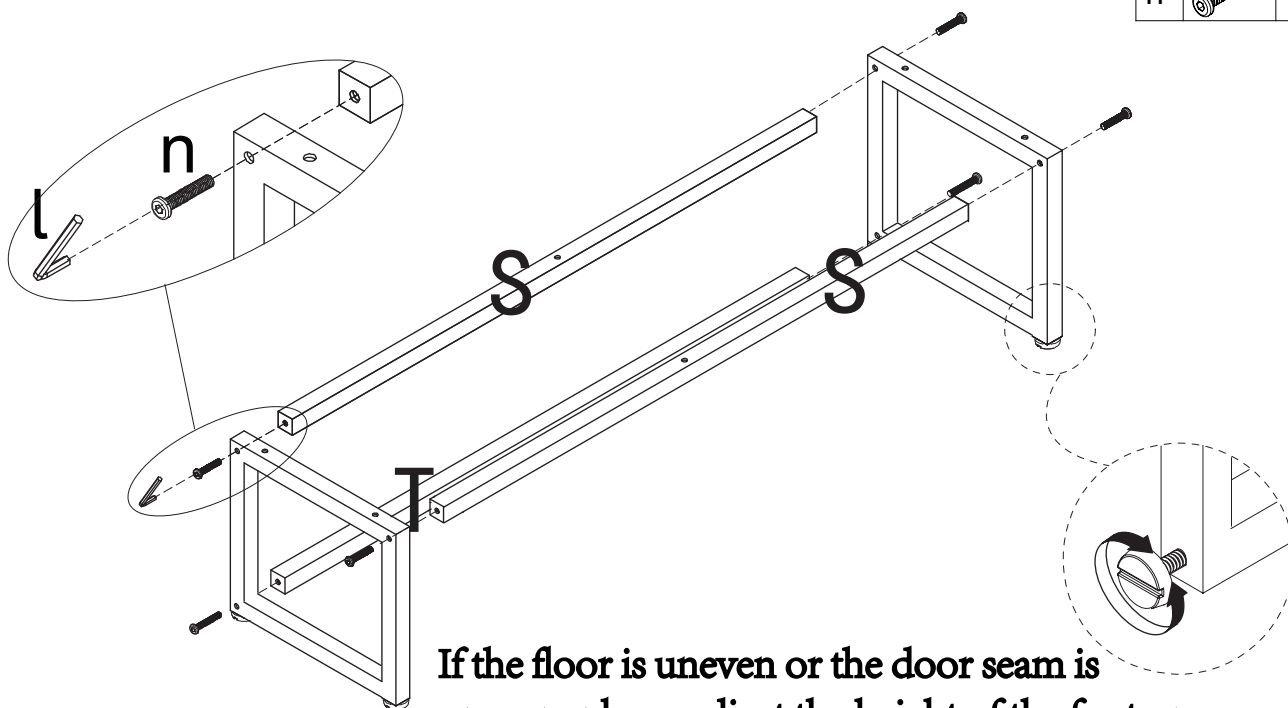

Step 1

l		1 PC
n		6 PCS



If the floor is uneven or the door seam is uneven, please adjust the height of the foot on the corresponding side until it is horizontal.

Step 2

a		8 SETS
b		8 PCS

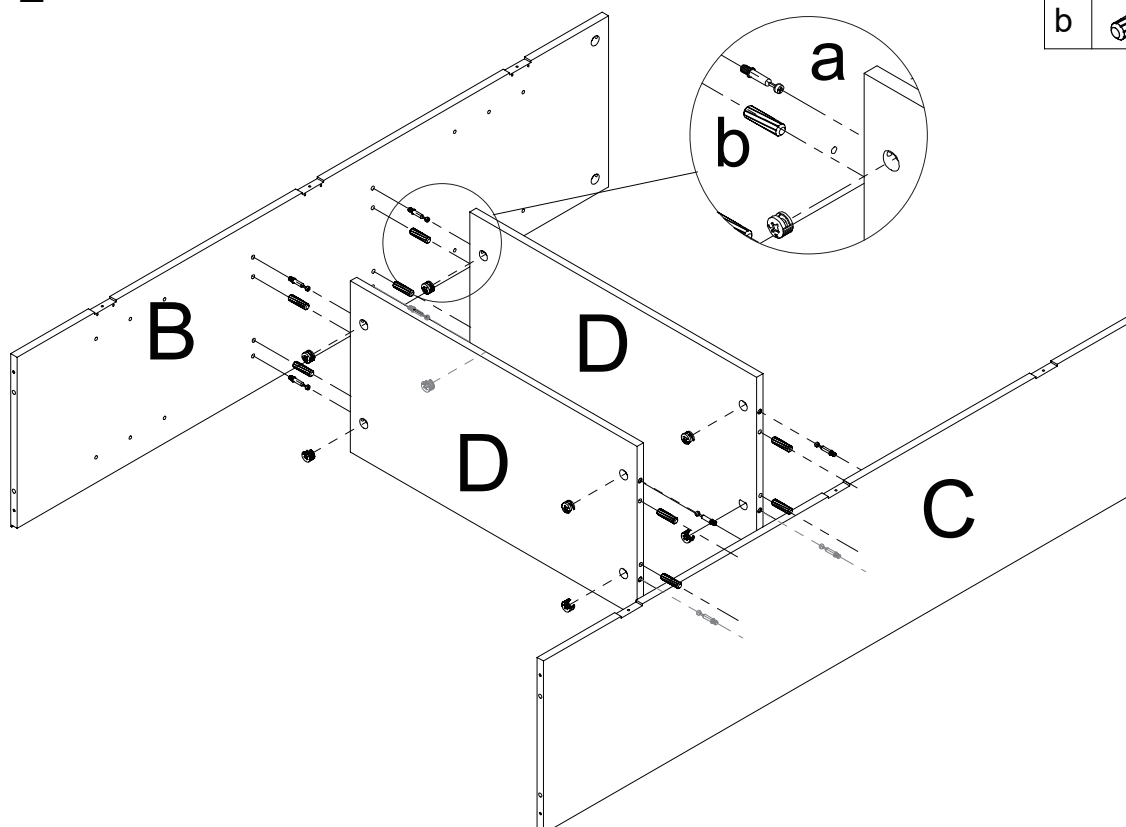



PRODUCT ASSEMBLY

Step 3

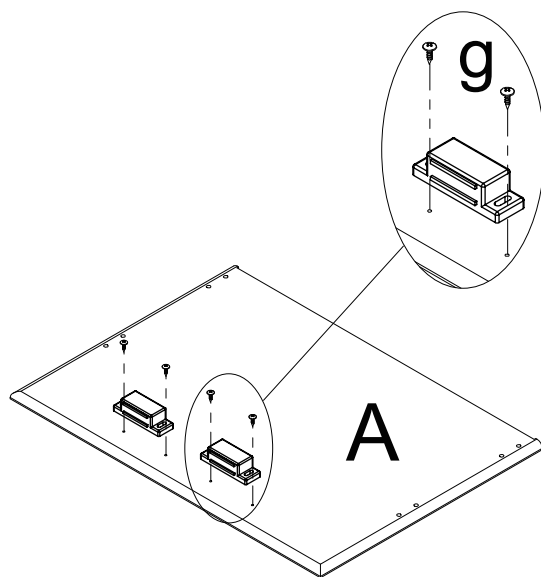
g	 2 PCS	2 SETS
---	---	--------



Step 4

a	 4 SETS
b	 8 PCS
m	 4 PCS

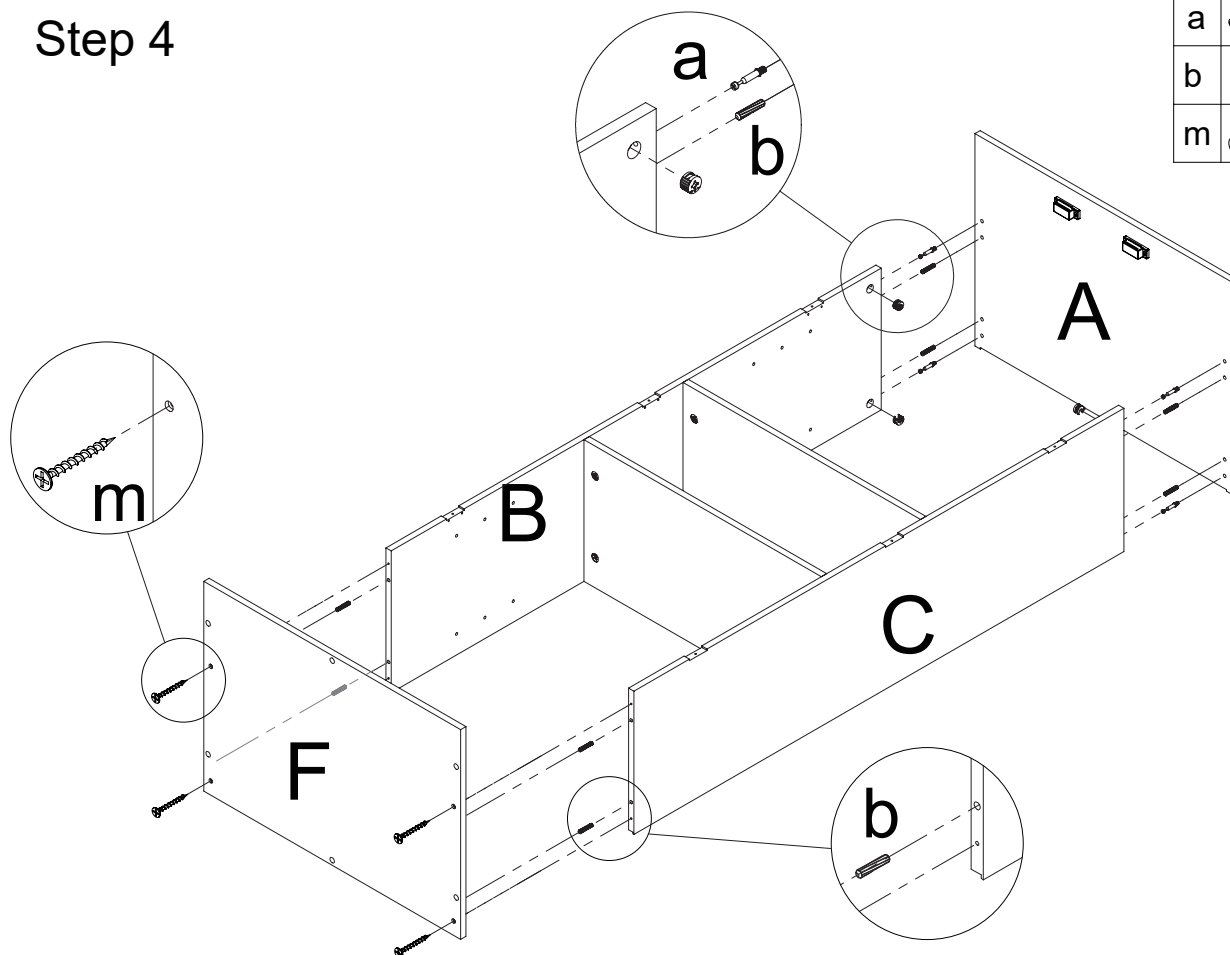

PRODUCT ASSEMBLY

Step 5



$XX=YY=90^\circ$

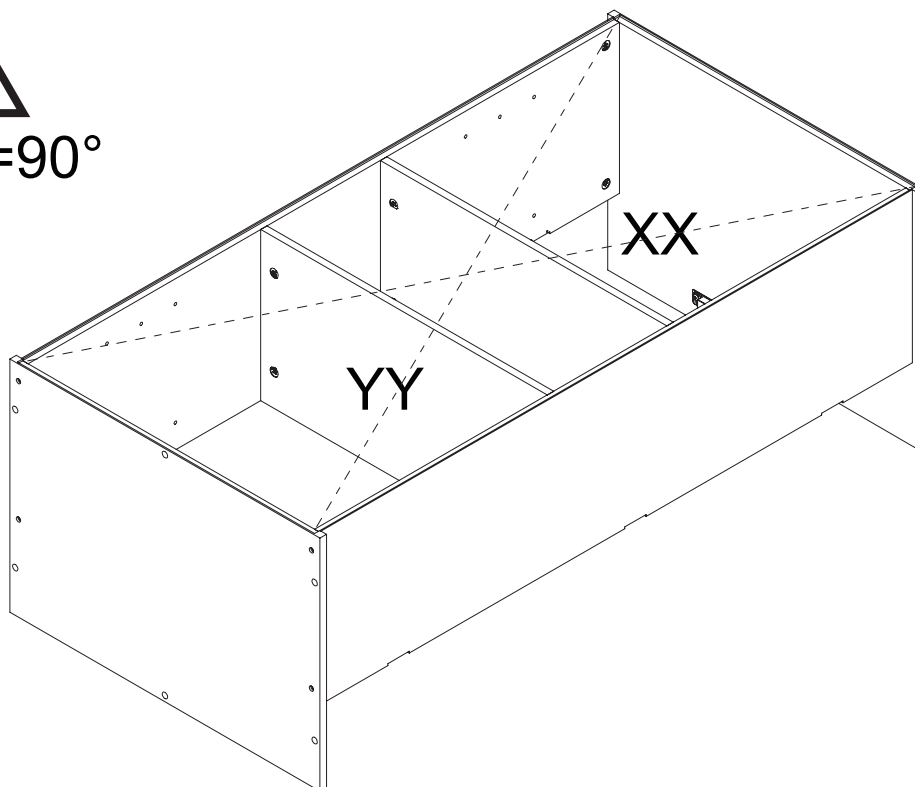

Step 6

c



26 PCS

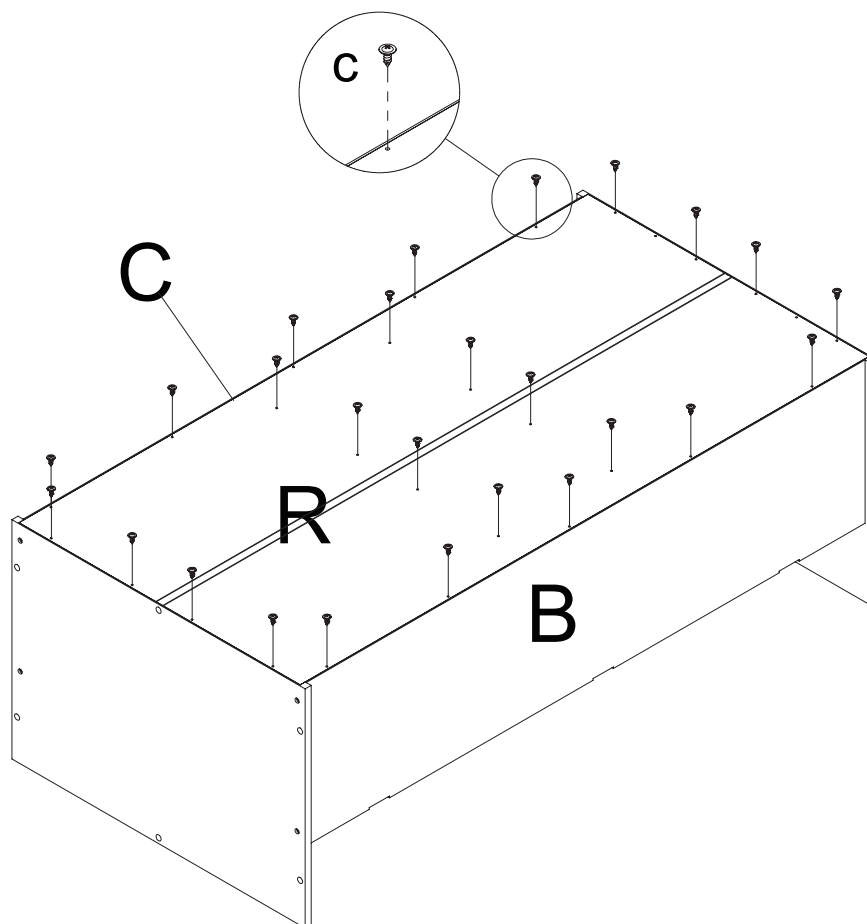



PRODUCT ASSEMBLY

Step 7

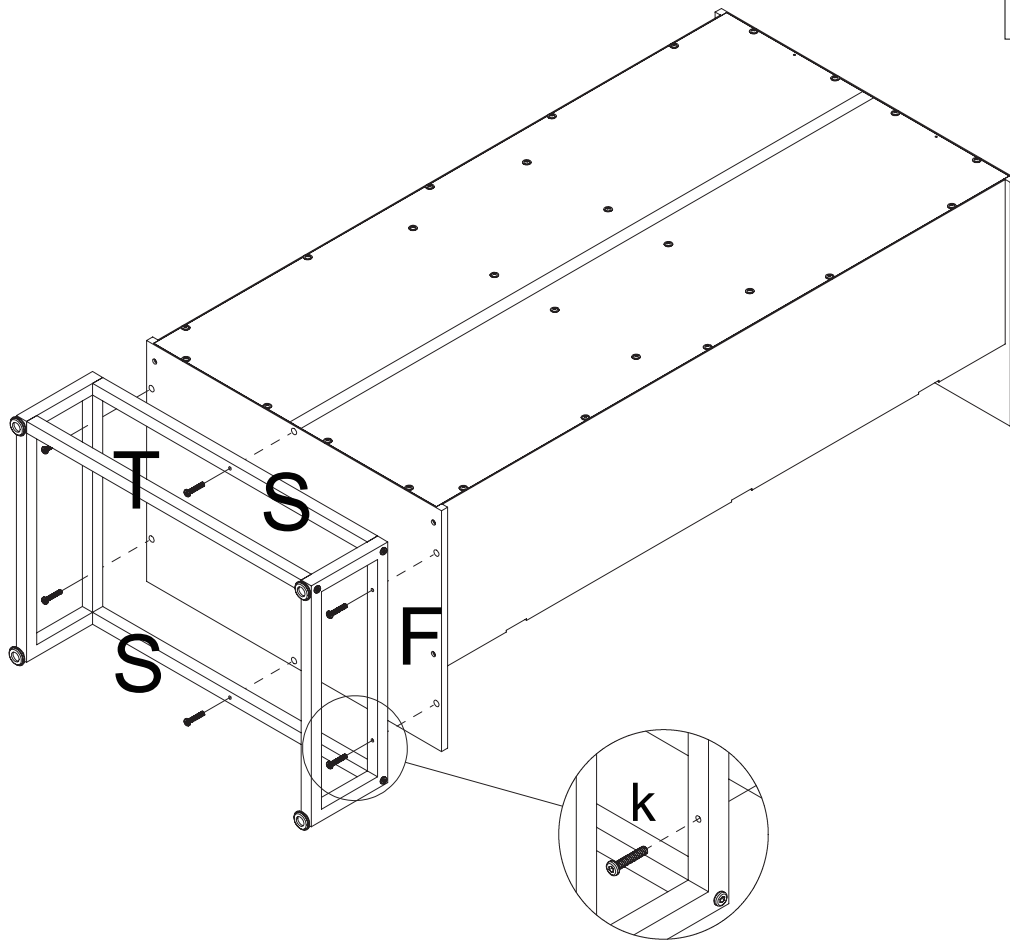
k		6 PCS
---	---	-------



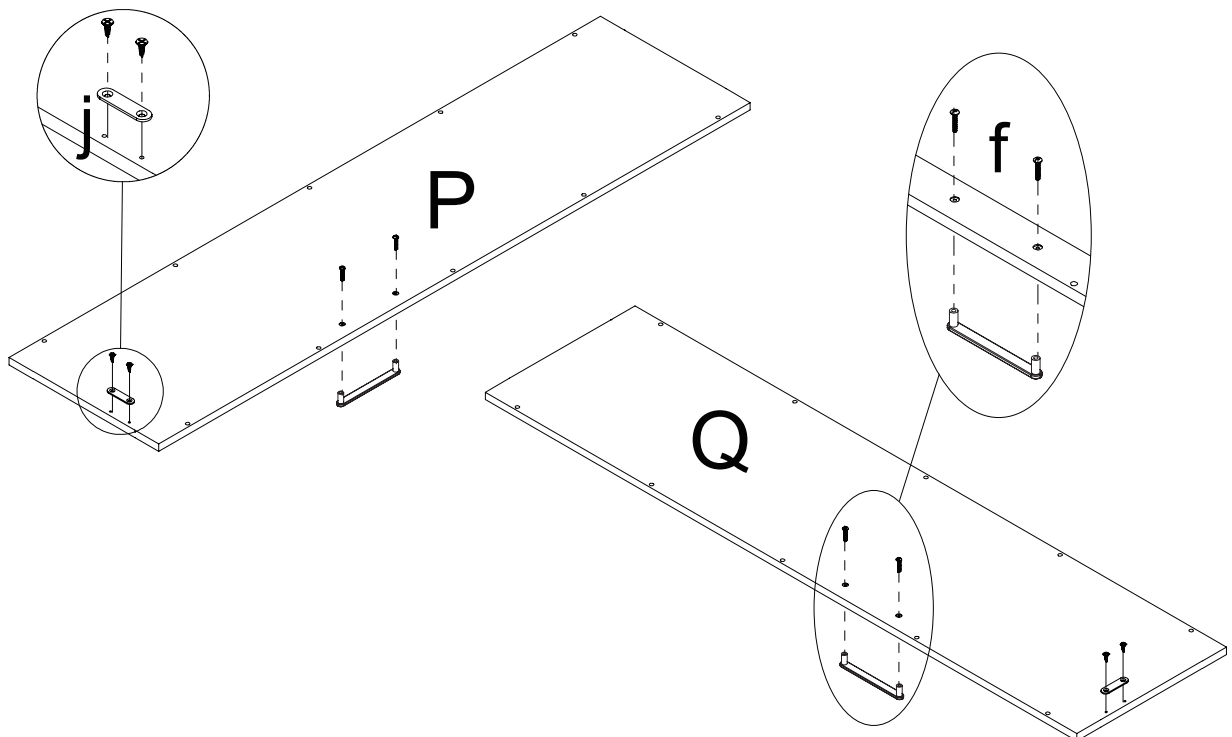

Step 8

f		2 PCS	2 SETS
j		2 PCS	2 SETS



PRODUCT ASSEMBLY

Step 9

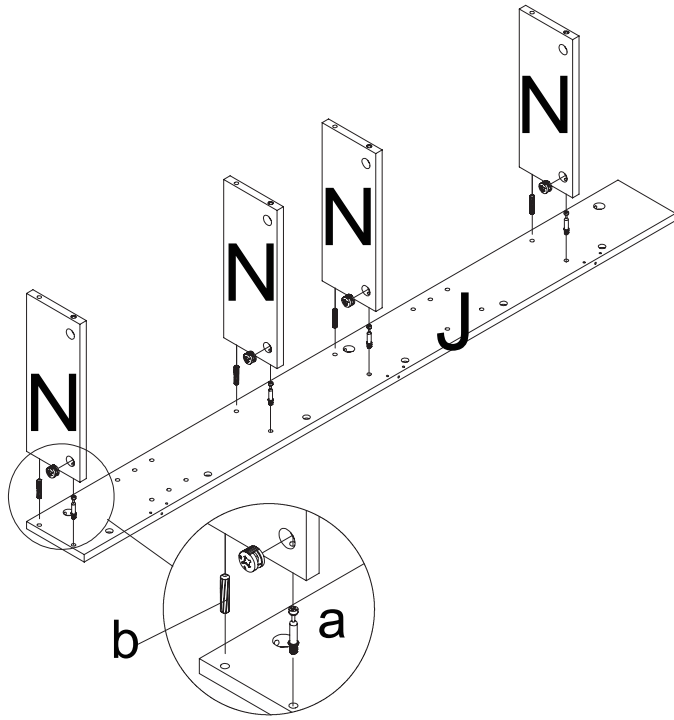

a		4 SETS
b		4 PCS

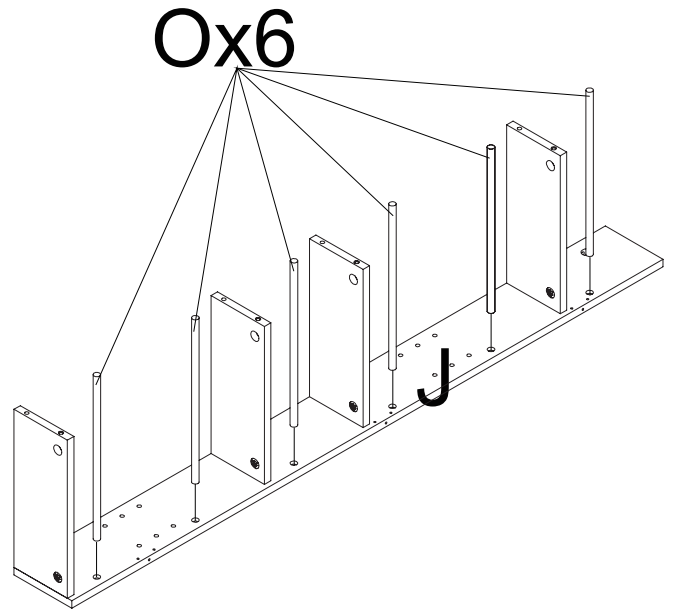

Step 10



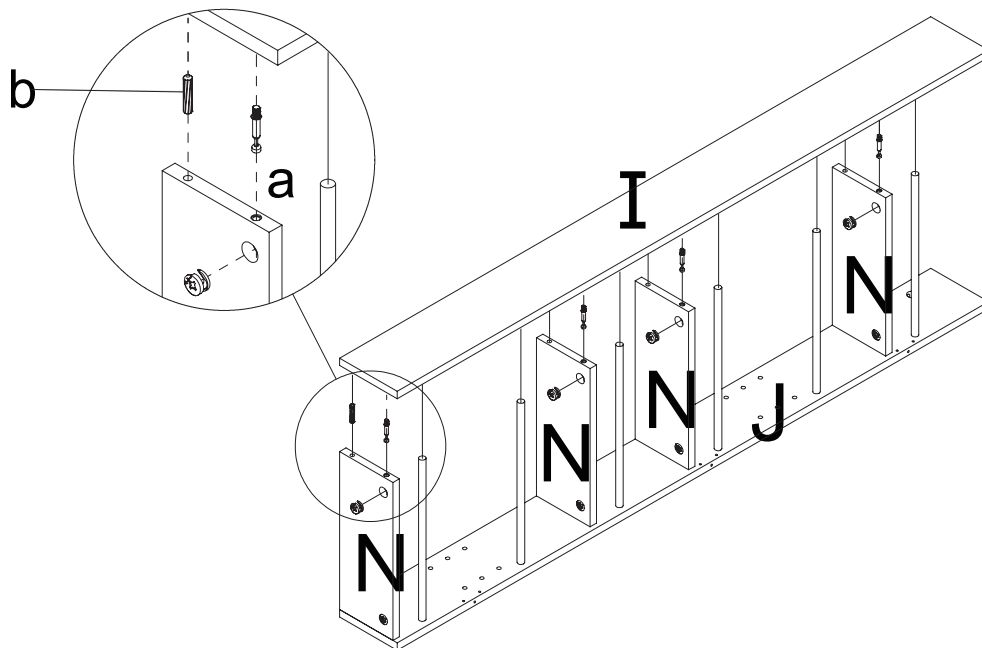

Step 11

a		4 SETS
b		4 PCS





PRODUCT ASSEMBLY

Step 12

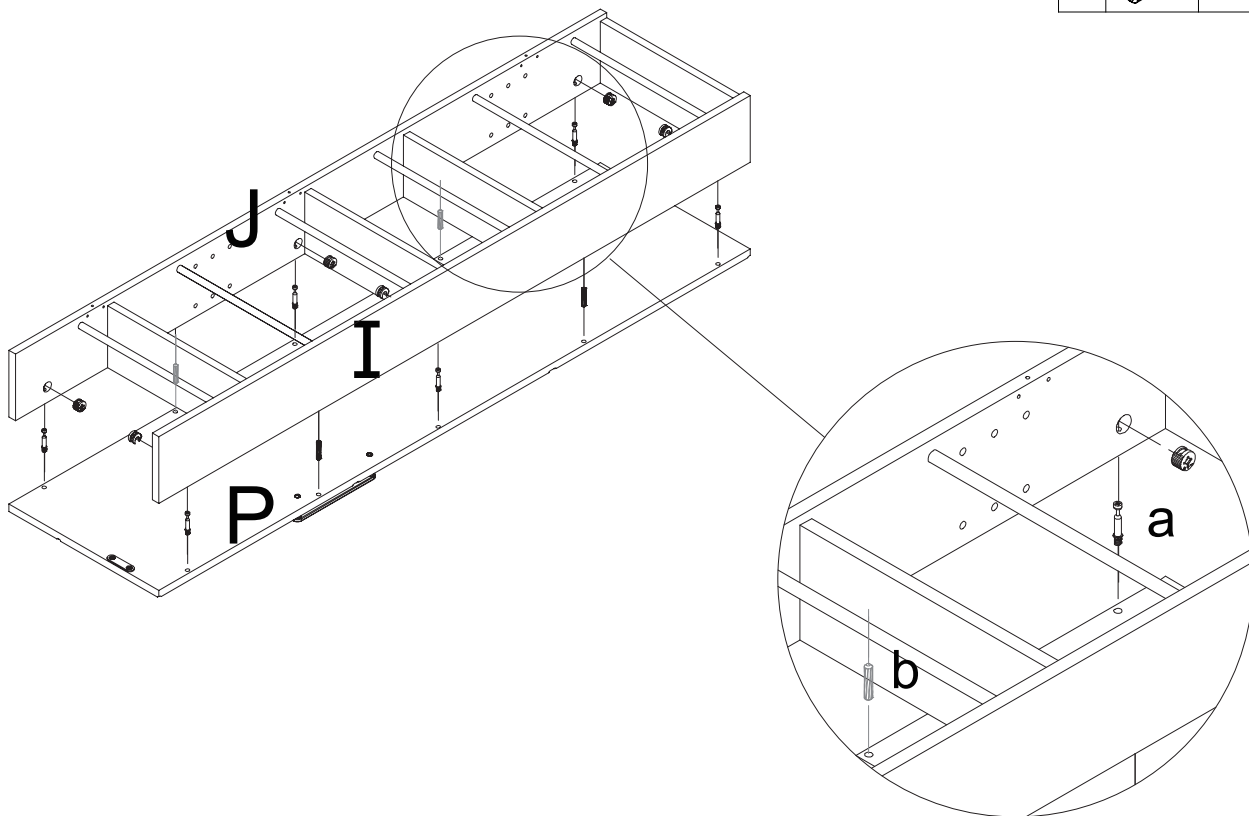
a		6 SETS
b		4 PCS



Step 13

a		4 SETS
b		4 PCS

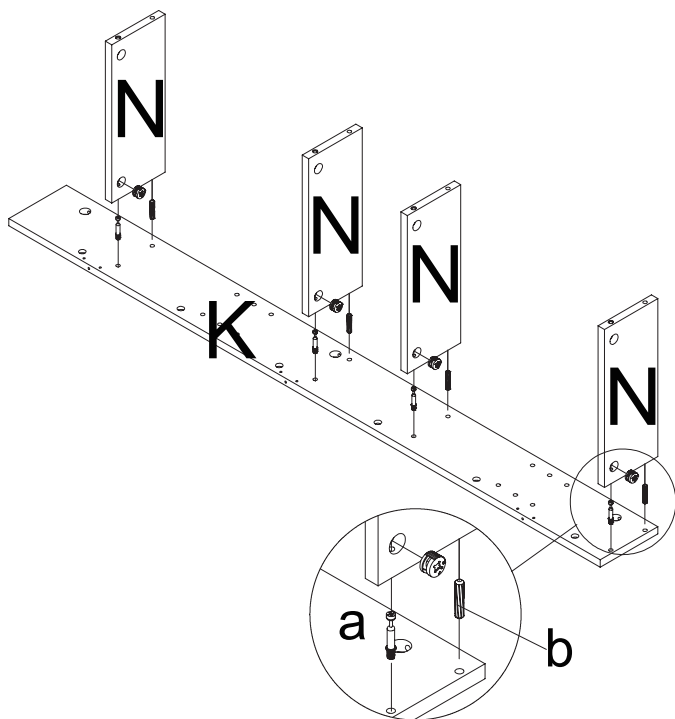

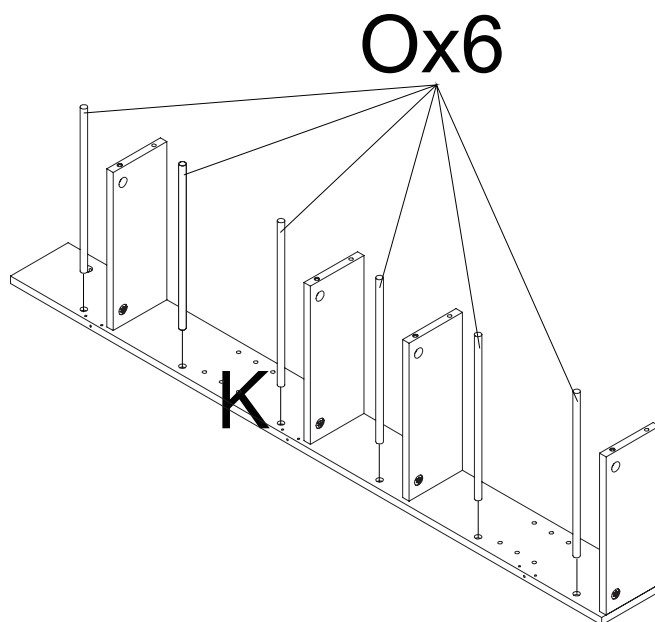

Step 14





PRODUCT ASSEMBLY

Step 15

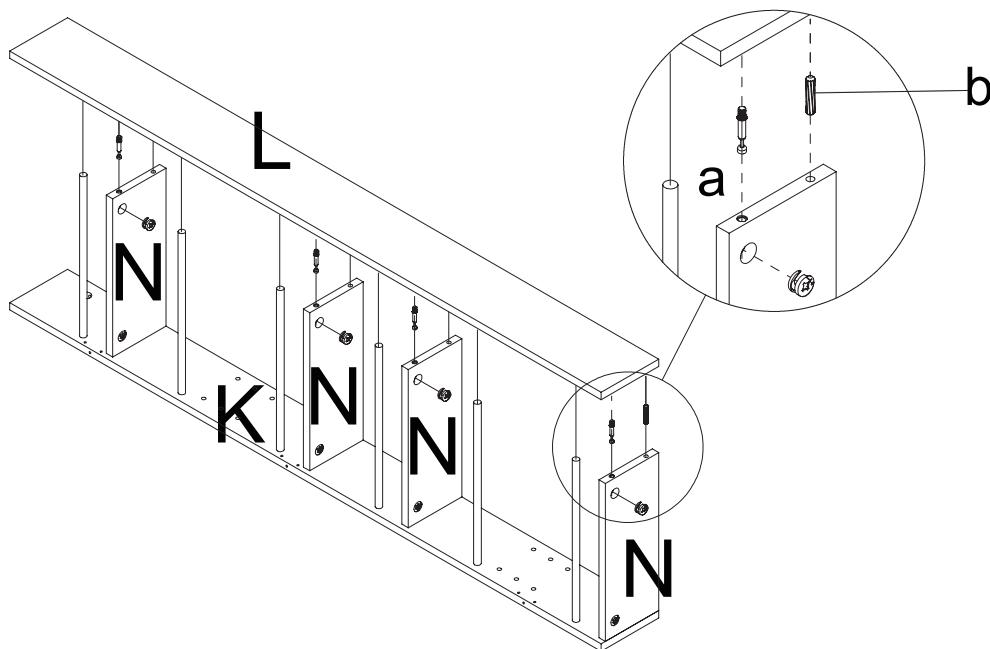
a		4 SETS
b		4 PCS



Step 16

a		6 SETS
b		4 PCS

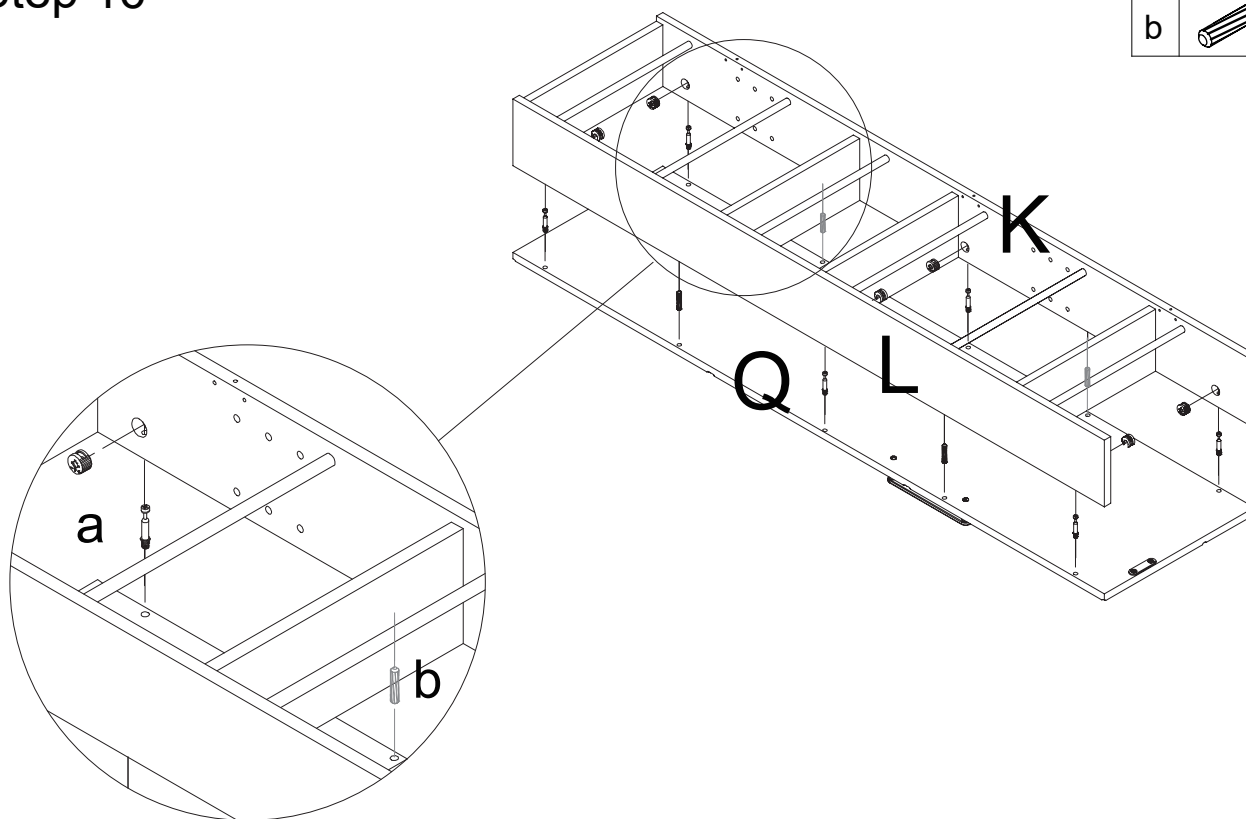

PRODUCT ASSEMBLY

Step 17

d  6 PCS 6 SETS

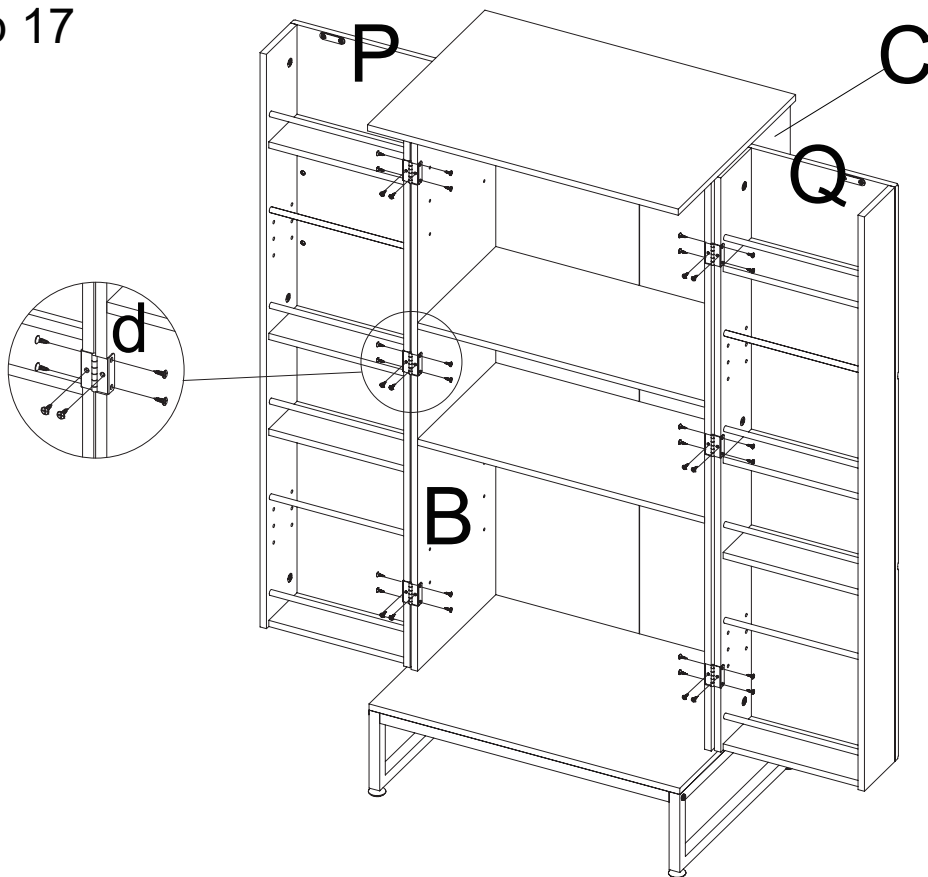

2 personas
para el armado

Step 18

e  24 PCS

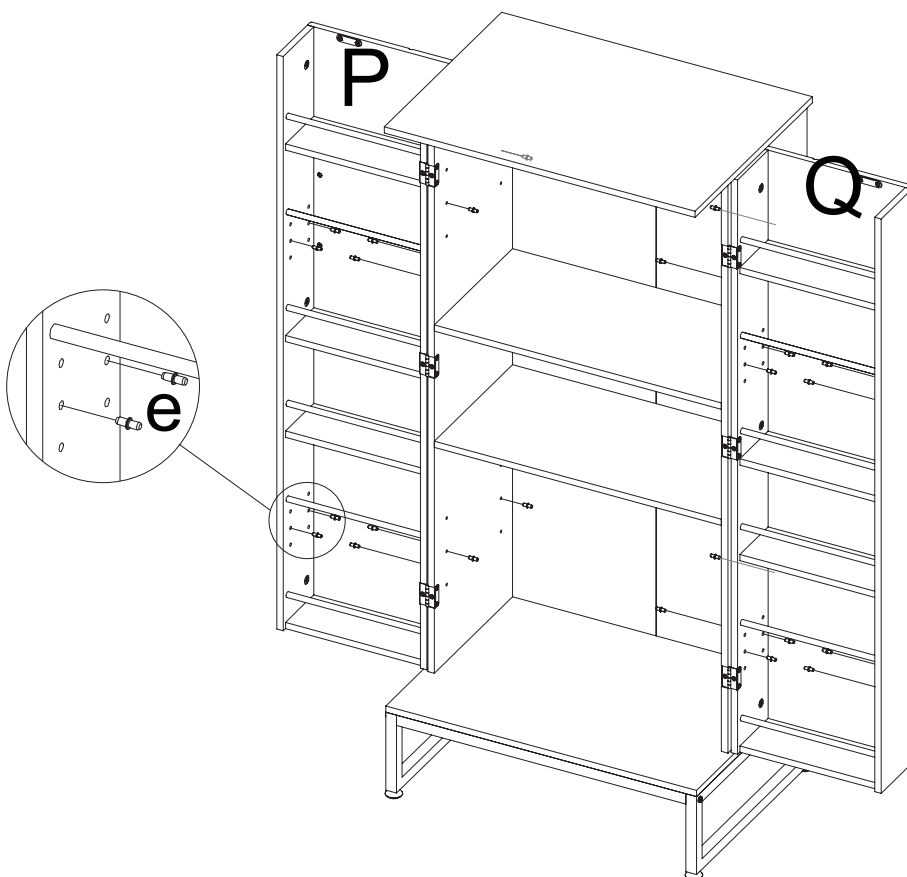

PRODUCT ASSEMBLY

Step 19

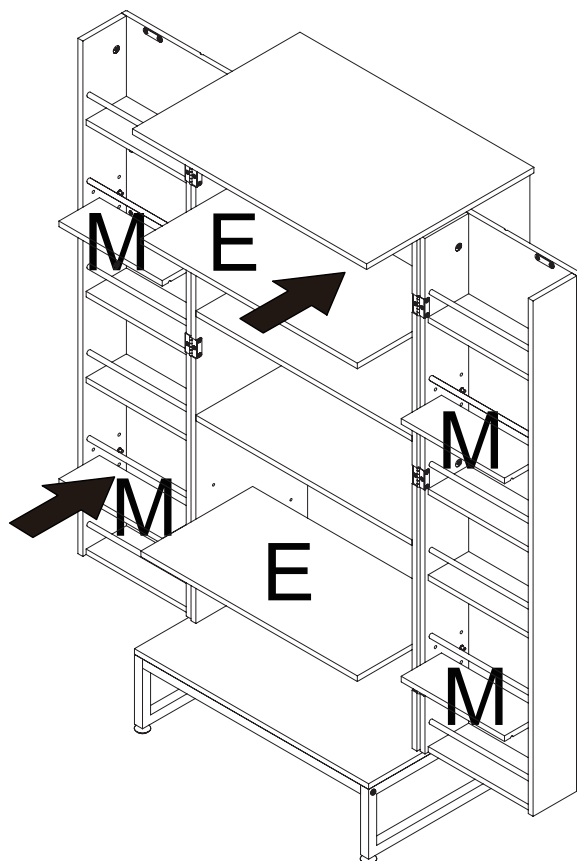

Step 20

WARNING!

IN ORDER TO PREVENT OVERTURNING
THIS PRODUCT MUST BE USED WITH THE
WALL ATTACHMENT DEVICE PROVIDED

h   2 SETS

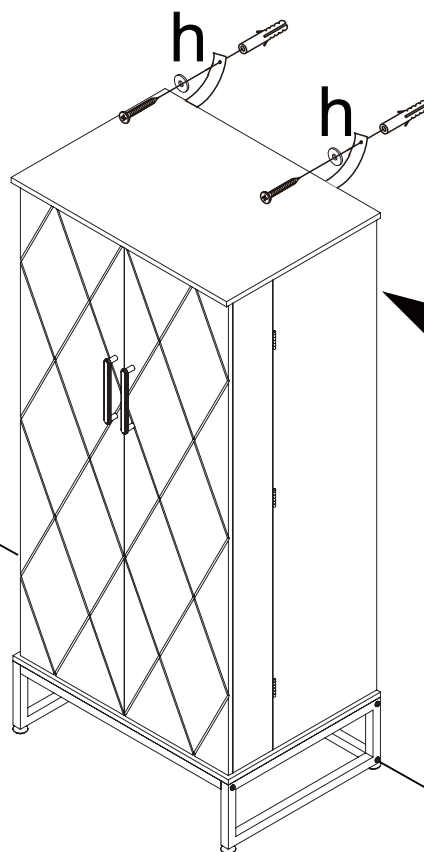

WARNING: Before
drilling, check wall
for hidden pipes and
cables

A Guide to Wall Mounting & Fixings

Important note:

If plastic wall plugs (rawl plugs) are supplied with your product, eg:



- these are suitable for use in masonry walls

If you are in any doubt about the correct wall plugs for your wall, seek professional advice.

Failure of the product due to using the incorrect fixings is the responsibility of the installer.



Important: when drilling into walls always check that there are no hidden wires or pipes etc.



Hints:

1. General rule: always use a larger screw and wall plug if you are not sure.
2. Ensure you use the recommended drill bit to match the wall plug and hole size.
3. Ensure you drill the hole horizontally; do not force the drill or enlarge the hole.
4. Take extra care when drilling high walls, ceilings and ceramic tiles. Ensure wall plugs are inserted beyond the thickness of the ceramic tiles to avoid the tiles splitting or cracking.
5. Ensure wall plugs are well fitted and are a tight fit in the drilled hole.

Types of walls

You can use one of the following types of wall plug if your walls are made of brick, breeze block, concrete, stone or wood.

No. 1 "General Purpose" wall plug

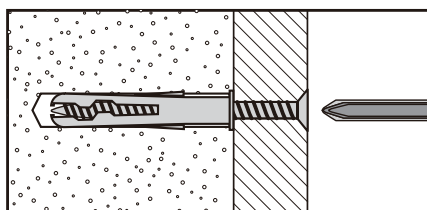

Generally aerated blocks should not be used to support heavy loads, use a specialist fitting in this case. For light loads, general purpose wall plugs can be used.

No. 3 "Cavity Fixing" wall plug

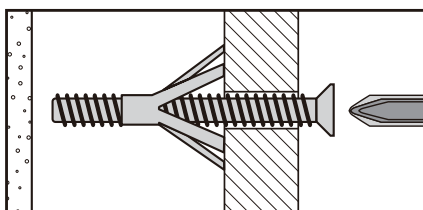

For use with plasterboard partitions or hollow wooden doors.

No. 5 "Hammer Fixing" wall plug

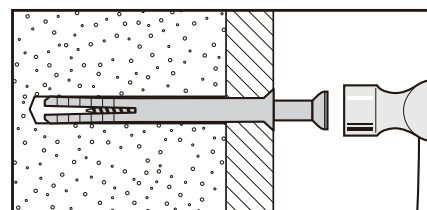

For use with walls stuck with plasterboard. The hammer fixing allows it to be fixed to the wall rather than the plasterboard. Always check the fixing is secure to the retaining wall.

No. 2 "Plasterboard" wall plug

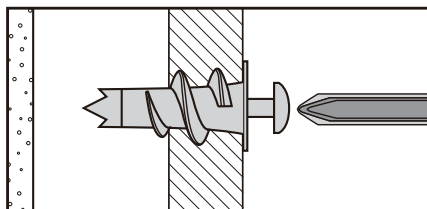

For use when attaching light loads onto plasterboard partitions.

No. 4 "Cavity Fixing - Heavy Duty" wall plug

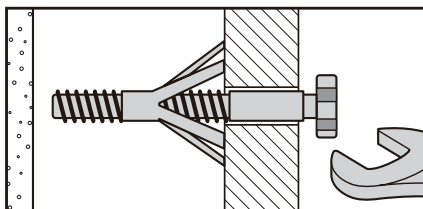

For use when fitting or supporting heavy loads such as shelving, wall cabinets and coat racks.

No. 6 "Shield Anchor" wall plug - heavy loads

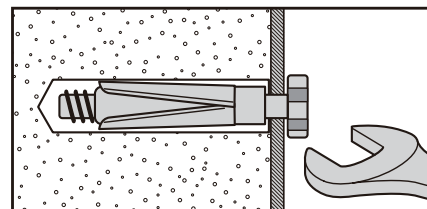

For use with heavier loads such as TV and HiFi speakers and satellite dishes etc.



Care & Maintenance

Safety: Always check the fitting and location to ensure your safety in and around the home.

Fitting: From time to time check the fitting to ensure the wall plugs or screws do not become loose.