

# Intelligent drying and sterilizing towel rack

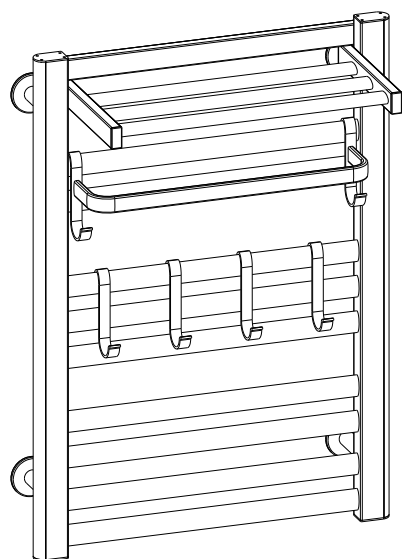

## OPERATION INSTRUCTION

### Dear users

Thank you for purchasing our carbon fiber intelligent electric towel rack for your correct use and safety. Please read this manual carefully before you use it, and please keep this manual for reference. Test, and properly keep the warranty card.

### First, matters needing attention

1. The product must be connected to the power supply consistent with the rated voltage displayed on the nameplate of the electrical appliance, and the power cord should be Ground wire, and need to connect the circuit connection of leakage short circuit (ELCB) protection.
2. It is forbidden to use the heating element or casing of this product when it is damaged.
3. This product is only used for drying washed fabrics, and silk fabrics are prohibited.
4. Children and the elderly with mobility difficulties should use this product under the supervision of someone, in order to avoid the right infants cause injury, and the product should be installed so that the lowest heating position is greater than the ground 700mm, the power cord socket should be located in a position to prevent flooding and splashing.

### Parts list

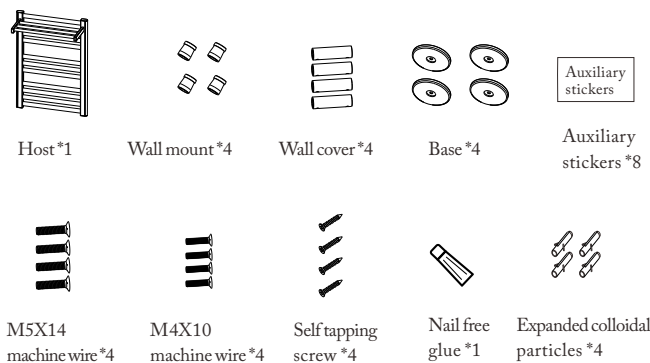

### Installation instructions

#### Installation method one (perforated wall hanging method)

1. Measure the size where you want to install the towel rack, And make the punch mark.
2. Punch 6 holes in the predetermined mark position.
3. Use a hammer to carefully knock the expanded rubber particles into the wall hole.
4. Follow the installation sequence of 3 to use the base and the wall. Tapping screws are screwed into the expansion rubber particles and fixed on the wall.
5. Then buckle on the fixed base with a wall-hanging sleeve, and use It is fixed by headless pointed-tail screws.
6. Fix the 4 bases one by one according to the above method.
7. Fasten the fixed base with the installed towel rack, And then fix the other side with a headless pointed-tail screw.

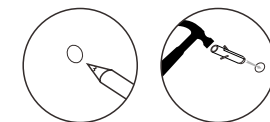

1. mark    2. knock the swelling colloidal particles

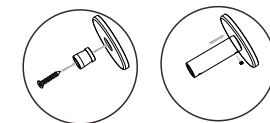

3. Apply nail-free glue and press it on the wall    4. Fasten the wall cover

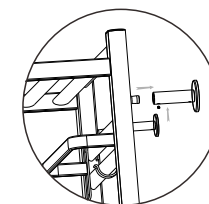

5. Connect the machine to the base

#### Tips:

When drilling, pay attention to safety!!!

The wall to be drilled must be a brick wall, otherwise it cannot be guaranteed.

Reliable installation of the towel machine!

#### Installation method two (no nail glue installation method)

Clean the wall dust, after cleaning the wall with neutral detergent. Wait until the wall is dry.

1. Mark the location where you want to install the towel machine.
2. Connect the base and the wall post with M5X14 machine wire, and
3. Spread nail-free glue evenly on the four bases,
4. Stick the base to the marked position and press firmly for 1-2 minutes.

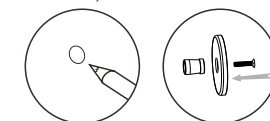

1. mark    2. Knock the swelling rubber particles

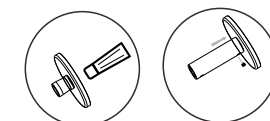

3. Apply nail-free glue and press on the wall    4. Fasten the wall cover

- Paste auxiliary stickers on both ends of the four bases
- Wait 72 hours (after the nail-free glue dries, the machine can be installed)
- Install the machine and the base together with a wall mount, and use It is fixed by headless pointed-tail screws.

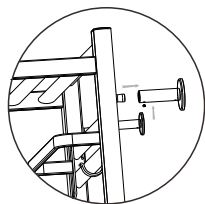

5. Connect the machine to the base

**Note:**

Nail-free glue is suitable for marble, frosted glass, porcelain  
Brick, solid wood, glass, antique brick wall (remember not to stick  
On the cement or back to the wall)

**\* List 1 of Optional Parts**



Hook \*4



Self tapping screw \*4



2 hole hook \*2

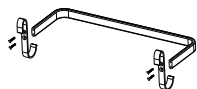

Curved hanger \*1

**Installation instructions:** align the self-tapping screw with the hole position and connect the 2-hole hook with the bent hanger with a ten-screwdriver Get up, then hang it on the towel rack and you can use it

**\* List 2 of Optional Parts**



Self tapping screw \*8



4 hole hook \*2

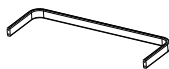

Curved fence \*1

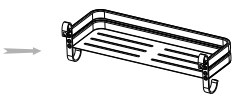
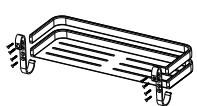
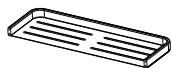

Storage chassis \*1

**Installation instructions:** align the self-tapping screw with the hole position, hook the 4-hole with the storage chassis with a ten-screwdriver, and bend the fence Connect them separately, and then hang them on the towel rack to use them

## Instructions for product use

- The main function of this product is to dry and store towels, bath towels and underwear to prevent towels, bath towels and Underwear suffers from mildew, peculiar smell, mites, etc. when it is not dried for a long time.
- The towel rack has grounding function when in use.  
The installation position should be as far away from the shower faucet as possible, so as to prevent the towel rack and remote control from being touched during bathing.
- Unplug the power plug when you don't dry towels and clothes for a long time.
- Dry clothes such as towels on a towel rack, and set the temperature at about 40-50°C.  
The timing time of this product can be selected by users from 2, 4, 6 and 8 hours. Do not put towels dripping with water directly on the towel rack.

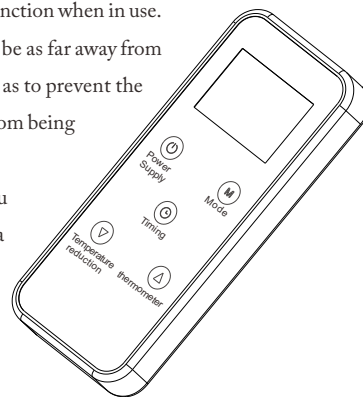

**Function description:**

**Drying mode:** constant temperature 50°C, temperature can not be adjusted.

**Heating mode:** the temperature can be adjusted freely, the adjustment range is 30-65°C

**Timing shutdown:** 0-8 hours, in increments of 2 hours, 0=no shutdown. Mobile phone control function, use existing APP, platform use Tuya.

**Networking method:**

Turn on, in the drying mode, press and hold the temperature up button for 5 seconds, after the screen displays OF, enter the automatic network configuration model.

Turn on and in the drying mode, press and hold down the temperature button for 5 seconds, after the screen displays OF, enter the manual network configuration model.



1. Scan code download: graffiti intelligence



2. Graffiti intelligently scans this code

## Maintenance and maintenance

- in order to better maintain this product, please wipe it with warm water and a soft towel (or sponge), containing Corrosive agents or bleaching agents are harmful to products.
- When maintaining or repairing the machine, please turn off the power or unplug it to ensure safety.
- Please do not hit the shell. This product is only for indoor installation and use.
- If there is any damage to the power cord, please contact the manufacturer directly or have electricity. Pay quality maintenance personnel replacement.

## After-sales Service

- The whole machine of our products is guaranteed for 3 years. Due to quality problems (non-natural disasters and man-made damage) during the warranty period, this product is of repairable structure, and can be sent back to the original factory for repair. If the product cannot be repaired, the faulty product will be replaced free of charge.
- If the product fails due to overdue warranty period, if the company still has spare parts, it will provide maintenance service, and charge a certain part fee and maintenance fee.
- The Company reserves the right of final interpretation of the said information.

## Warranty card

Relevant information (filled in by user)	
User name	Common telephone
Mailing address	
product model	Product code
Buy a shop	Date of purchase
maintenance point	Invoice number

Maintenance Record	
Maintenance date	
Fault content	
Processing details	
Maintenance unit name	
Signature of maintainer	

Please fill in this warranty card immediately when purchasing our products  
Please keep the warranty card properly, and consumers don't have to send it back to our company  
Please bring the warranty card and the original valid invoice when repairing