

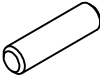







## ASSEMBLY INSTRUCTIONS

# PARTS LIST

Name	Part	Qty.	Spare Qty.	Name	Part	Qty.	Spare Qty.
<b>A</b>	 Wood Dowel	8	1	<b>F</b>	 4x14mm	14	2
<b>B</b>	 Cam Post	14	1	<b>G</b>	 Shelf Cam	4	
<b>C</b>	 Cam Lock	14	1	<b>H</b>	 Shelf Cam Post	4	
<b>D</b>	 Cam Sticker	14	1		 HARDWARE		
<b>E</b>	 Leveler	3					

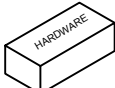
Items with HB are in hardware box.

\*\*Denotes Color Code

# PARTS LIST

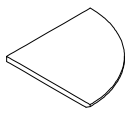
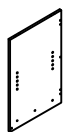
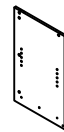
Name	Part	Qty.
<b>K</b>	 Top	<b>1</b>
<b>L</b>	 Left Side Panel	<b>1</b>
<b>M</b>	 Right Side Panel	<b>1</b>

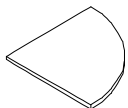
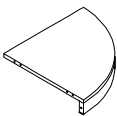
Name	Part	Qty.
<b>N</b>	 Adjustable Shelf	<b>1</b>
<b>O</b>	 Bottom Shelf	<b>1</b>

\*\*Denotes Color Code

**2**

## IMPORTANT!

**Review ALL instructions before beginning assembly.** These instructions are provided to avoid problems that may occur from improper assembly or installation. Mayline and/or its distributor are not responsible for failure resulting from improper assembly or installation of this product. Moreover, all warranties are void for failure to follow these assembly instructions.

- 1 Insert the Cam Post (B) and Wood Dowel (A) into Right Side Panel (M). Attach Right Side Panel (M) to Bottom (O) by turning Cams (C). Insert the Cam Post (B) and Wood Dowel (A) into Left Side Panel (L). Then Attach Right Side Panel (M) and Bottom (O) to Left Side Panel (L) by turning Cams (C).

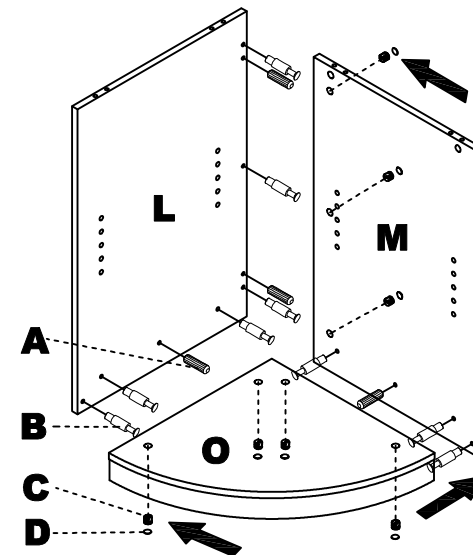

**3**

- ② Attach Levelers (E) to the Bottom Shelf (O) using Screws (F).

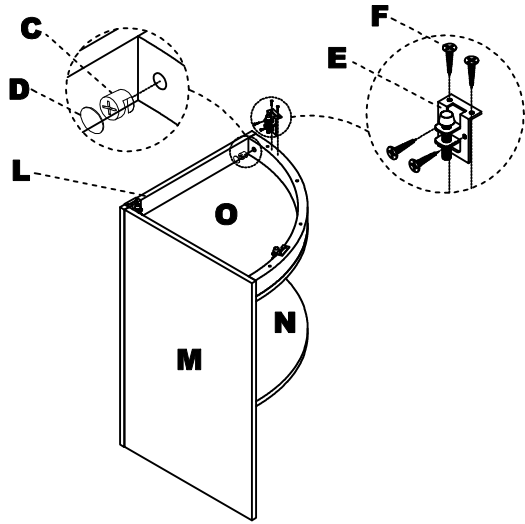

- ③ Attach Top (K) to Side Panels (L & M) by turning Cams (C). Apply Cam Stickers (D) onto Cams (C) of Side Panels (L & M).

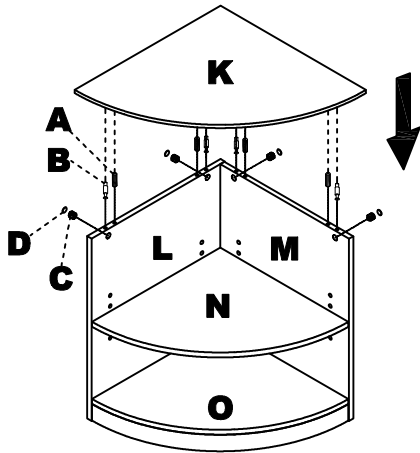

4

- ④ Insert Shelf Cam (G) into Adjustable Shelf (N) with open slot in cam to edge of shelf. Screw Shelf Cam Posts (H) into Side Panels (L & M). Press Shelves onto Shelf Posts. Turn Shelf Cam (G) screw to lock in place.

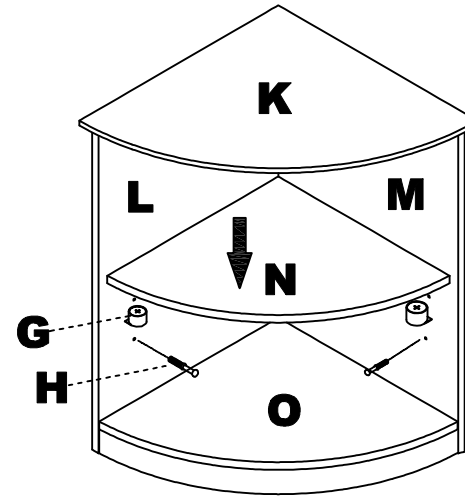

5