

Dresser-6 Drawers



Instruction Manual

Thank you for shopping with us!

We appreciate your purchase and are ready to be at your service!

If you find parts missing, broken, or hard to put together or when you are not satisfied or have any valuable suggestions, please do not hesitate to contact us first!

We will definitely give you a satisfactory solution or answer then!



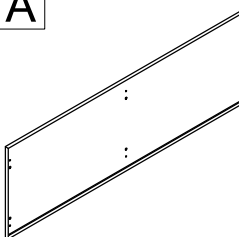
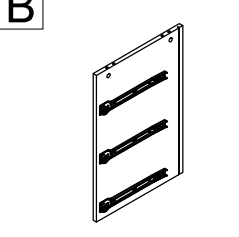
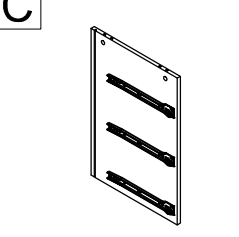
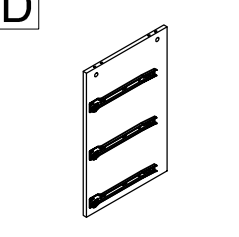
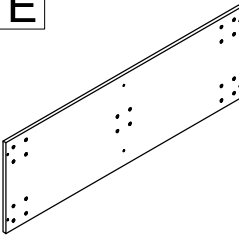
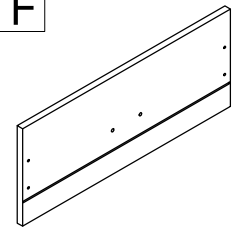
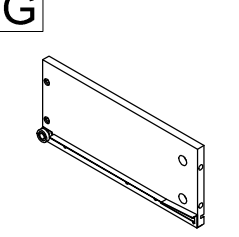
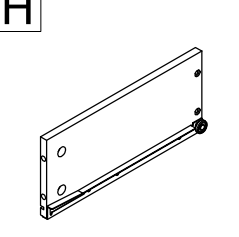
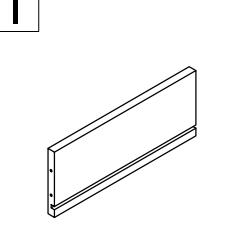
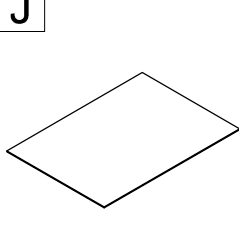
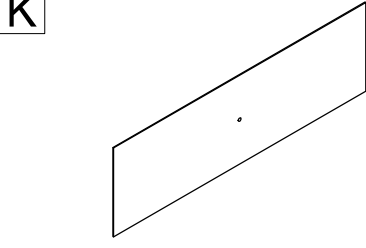
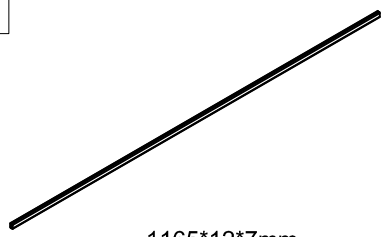



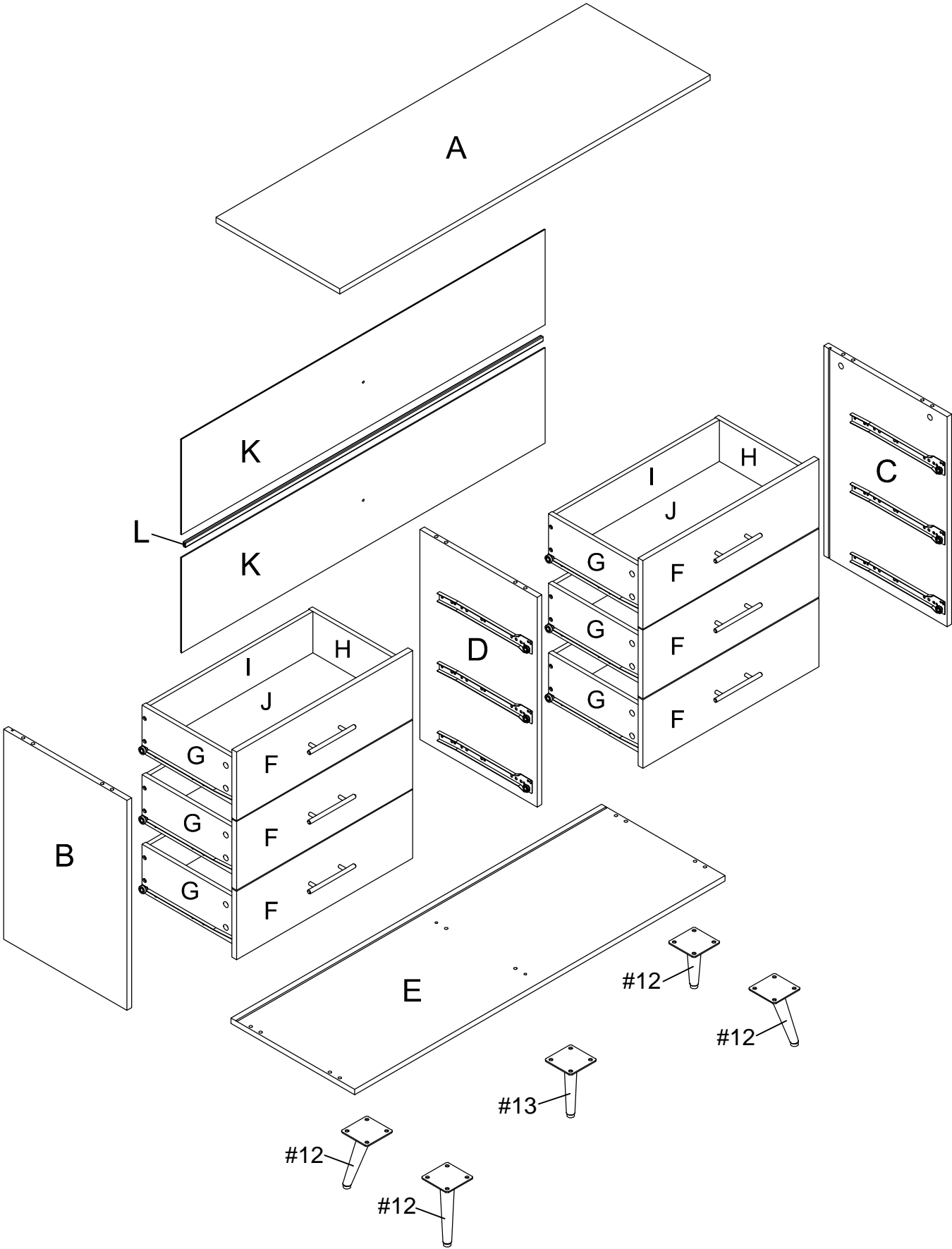



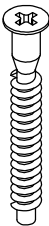

PART LIST

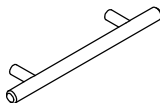
				
<p>Top Panel</p> <p>1 PC</p>	<p>Left Panel</p> <p>1 PC</p>	<p>Right Panel</p> <p>1 PC</p>	<p>Partition Panel</p> <p>1 PC</p>	<p>Bottom Panel</p> <p>1 PC</p>
				
<p>Drawer Front Panel</p> <p>6 PCS</p>	<p>Drawer Left Panel</p> <p>6 PCS</p>	<p>Drawer Right Panel</p> <p>6 PCS</p>	<p>Drawer Back Panel</p> <p>6 PCS</p>	<p>Drawer Bottom Panel</p> <p>6 PCS</p>
	 <p>1165*12*7mm</p>			
<p>Back Panel</p> <p>2 PCS</p>	<p>Back Plastic Strip</p> <p>1 PC</p>			

ASSEMBLY OVERVIEW

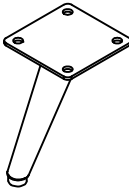
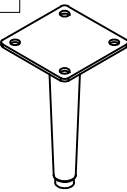

HARDWARE LIST

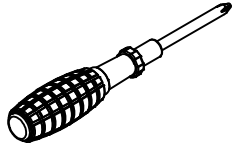
<p>#1</p>  <p>Ø5*40mm</p>	<p>#2</p>  <p>Ø8*30mm</p>	<p>#3</p>  <p>Ø3*30mm</p>	<p>#4</p>  <p>Ø6*35mm</p>	<p>#5</p>  <p>Ø15*9mm</p>
<p>Screw</p> <p>6 PCS (Extra 1)</p>	<p>Wood Dowel</p> <p>12PCS (Extra 2)</p>	<p>Screw</p> <p>24PCS (Extra 3)</p>	<p>Cam-bolt</p> <p>30PCS (Extra 3)</p>	<p>Cam-lock</p> <p>30PCS(Extra 3)</p>
<p>#6</p>  <p>150*32*Ø12mm</p>	<p>#7</p>  <p>M4*22mm</p>	<p>#8</p> 	<p>#9</p>  <p>Ø3.5*15mm</p>	<p>#10</p>  <p>M6*12mm</p>
<p>Handle</p> <p>6 PCS</p>	<p>Round Head Bolt</p> <p>12 PCS (Extra 2)</p>	<p>Back Bracket</p> <p>6 PCS (Extra 2)</p>	<p>Screw</p> <p>8 PCS (Extra 2)</p>	<p>Bolt</p> <p>20 PCS (Extra 2)</p>
<p>#11</p>  <p>4mm</p>	<p>#12</p> 	<p>#13</p> 	<p>#14</p> 	
<p>Allen Wrench</p> <p>1 PC</p>	<p>Leg</p> <p>4 PCS</p>	<p>Center Leg</p> <p>1 PC</p>	<p>Safety Strap Kit</p> <p>2 SET</p>	<p>Phillips Screwdriver</p> <p>1 PC</p>

Instructions For Fastening CAM-BOLT and CAM-LOCK

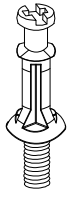

CAM-BOLT



CAM-LOCK

Tools Required

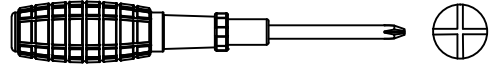

INSERTING AND TIGHTENING CAM-BOLT

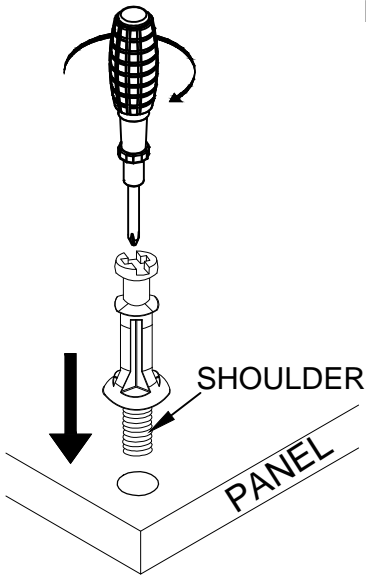

Place Cam-bolt on pre-drilled hole and screw in vertically

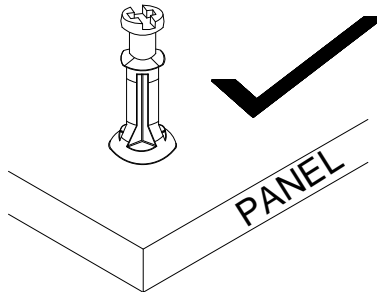

Shoulder is flushed (on the same level) with the panel.

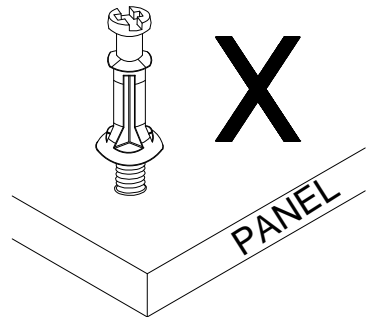

Shoulder is above the panel.

Place Cam-bolt on the designated pre-drilled holes on the panel. Use a Phillips Screwdriver to screw-in Cam-bolt vertically until shoulder is flushed (on the same level) with panel.

INSERTING CAM-LOCK

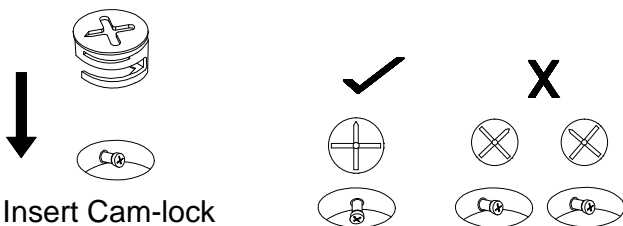

Insert Cam-lock with arrow align to Cam-bolt head

CORRECT

WRONG

Align the arrow on the Cam-lock to the Cam-bolt head and insert the Cam-lock. Ensure Cam-lock is fully inserted.

TIGHTENING CAM-LOCK

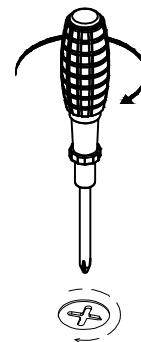

Use a Flat-head Screwdriver to turn Camlock clockwise so it locks onto the head of the Cam-bolt. Turn until it is snug (about 3/4ths of a turn) -- over-tightening could damage Cam-lock or/and Cam-bolt.

Step 1.

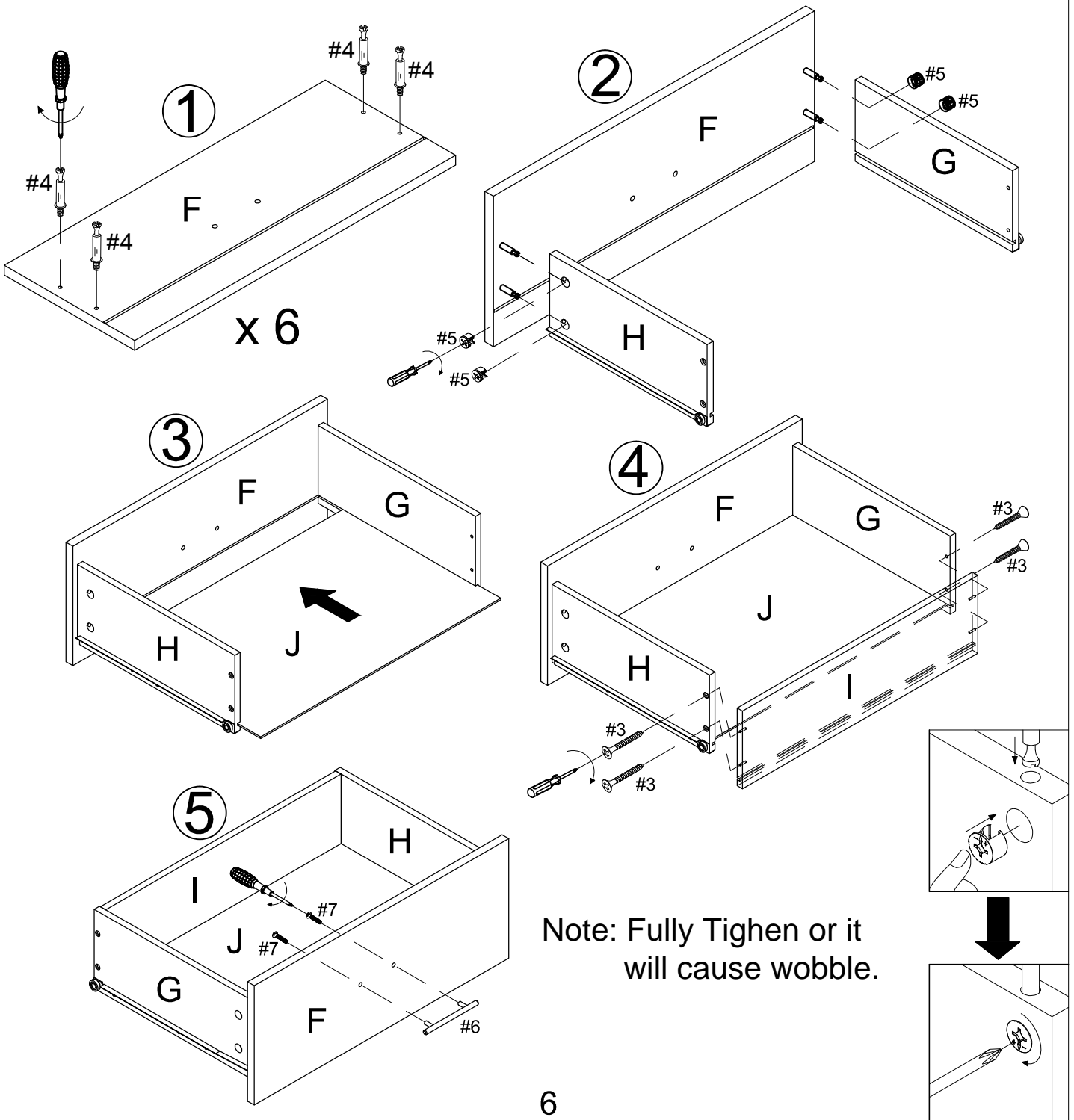
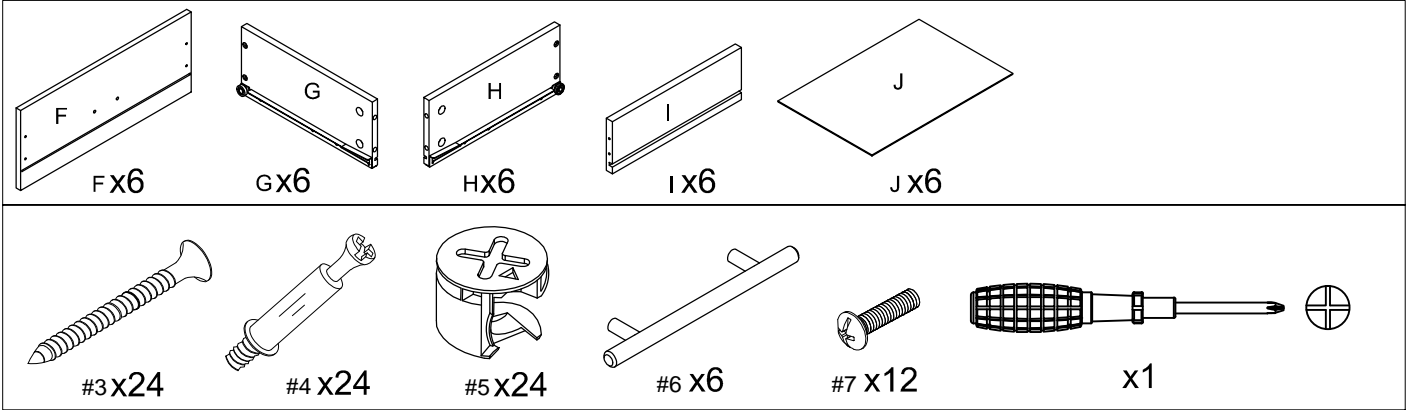

Step 2.

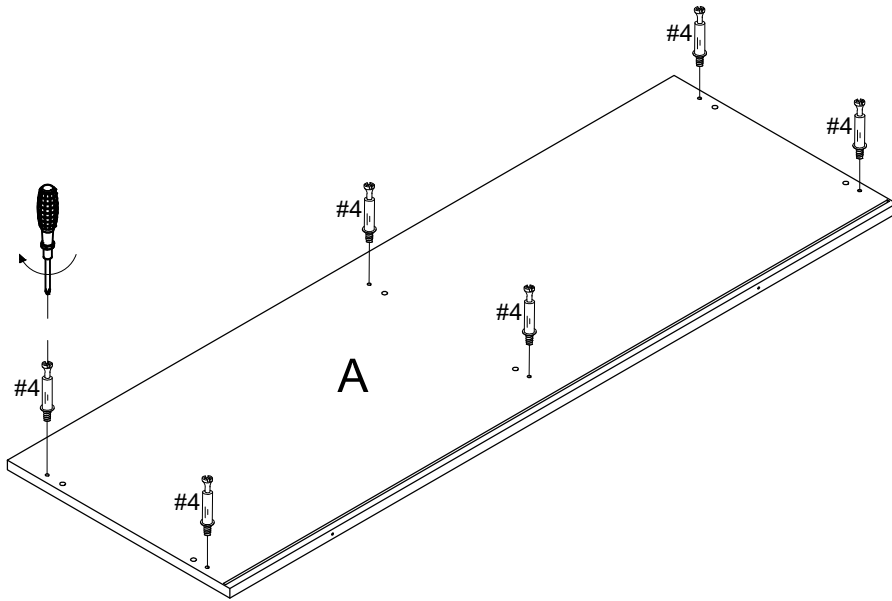
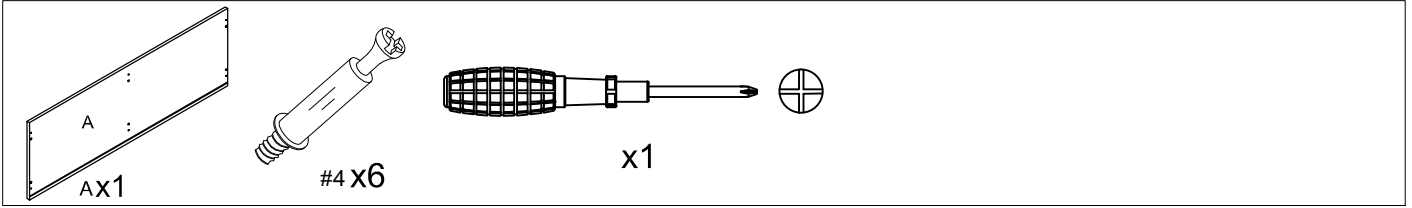

Step 3.

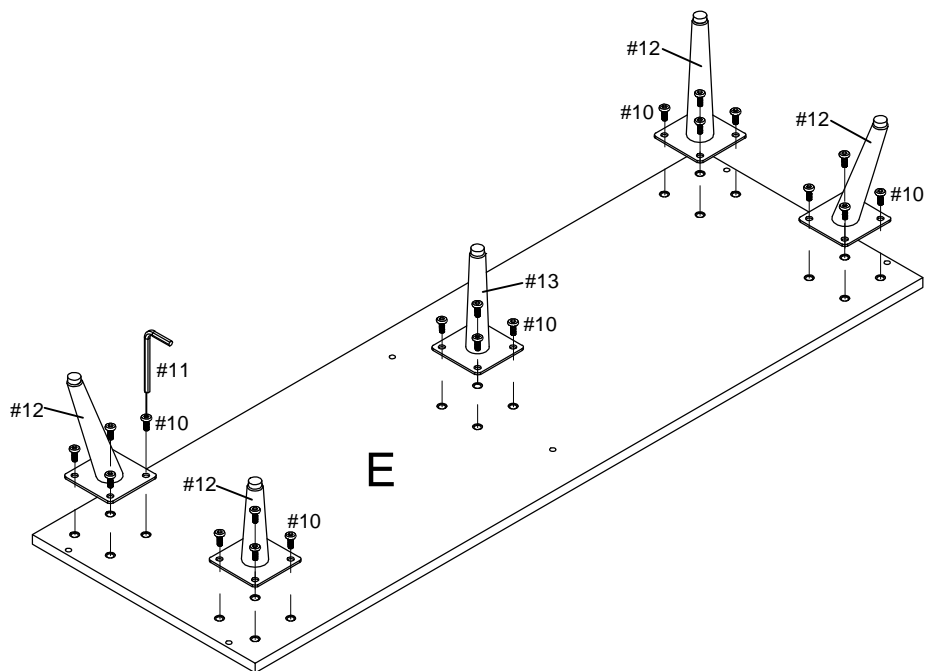
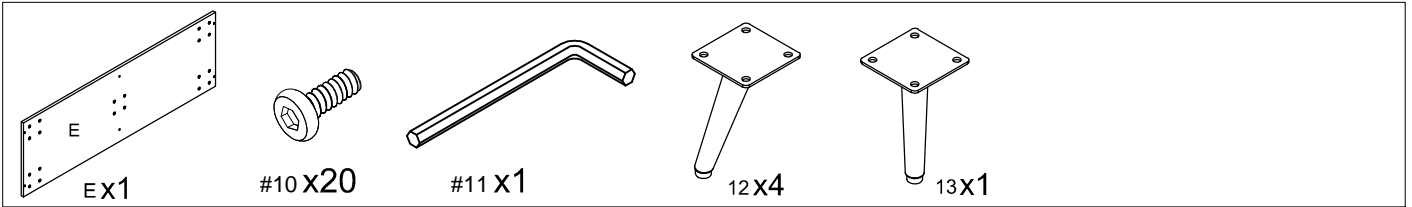

Step 4.

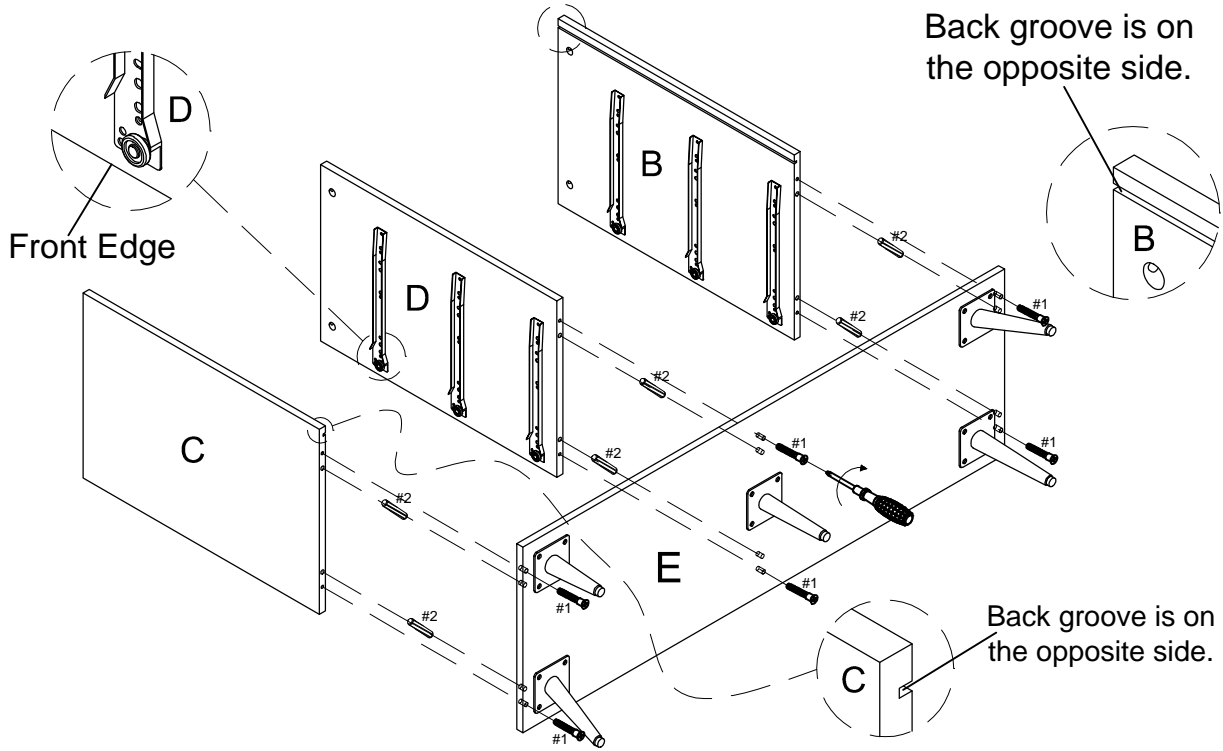
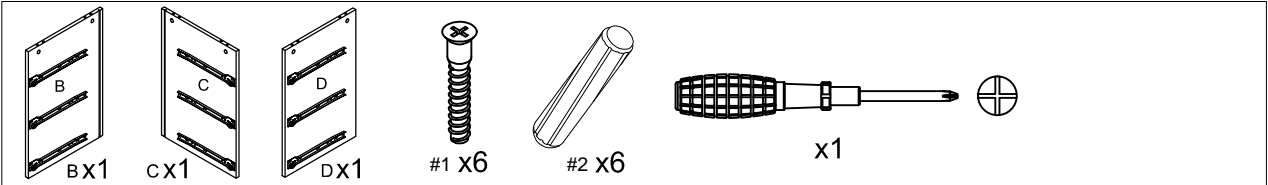

Step 5.

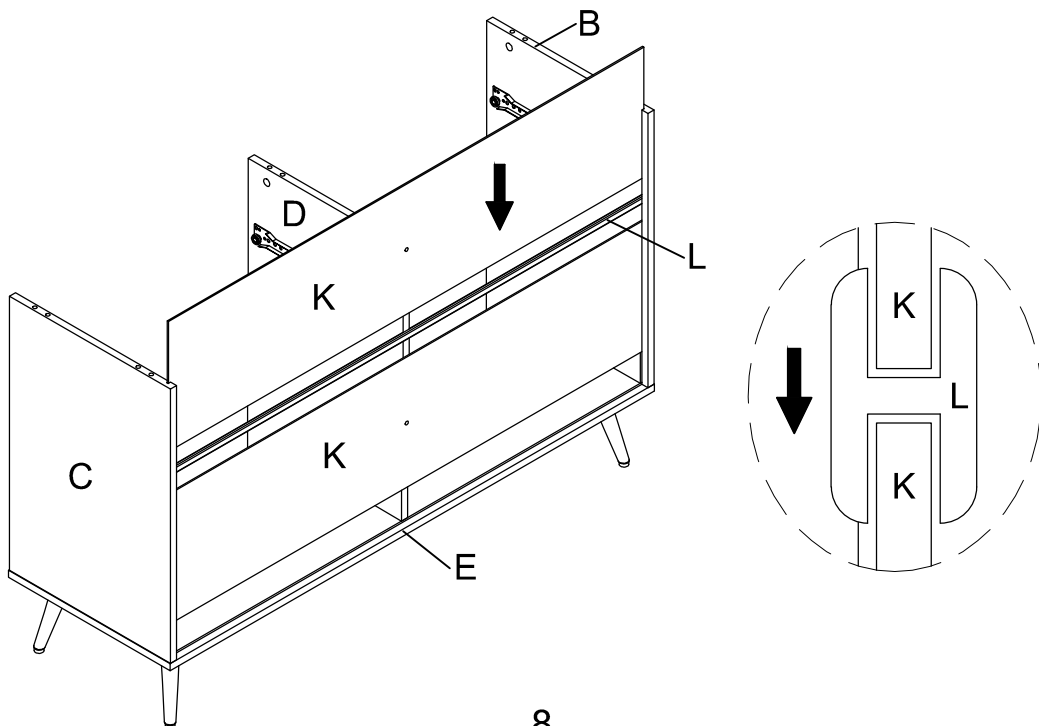

Step 6.

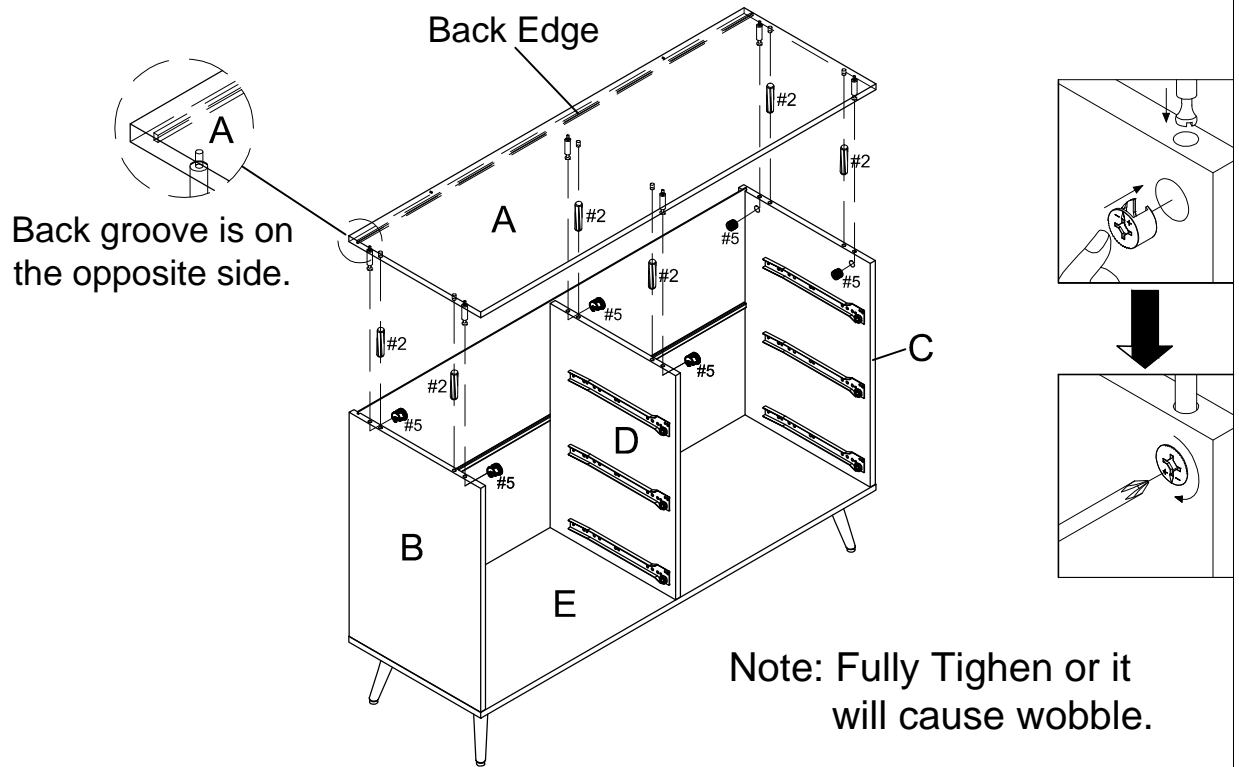
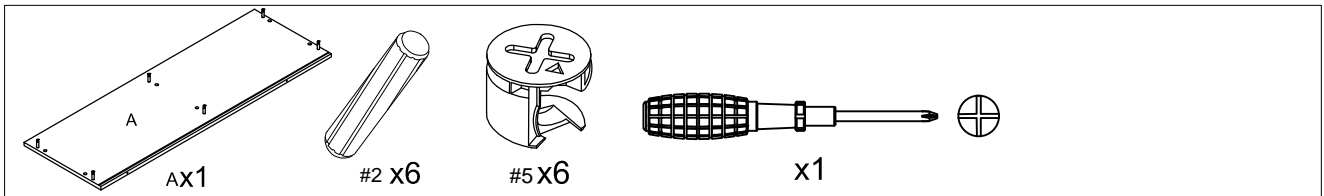

Step 7.

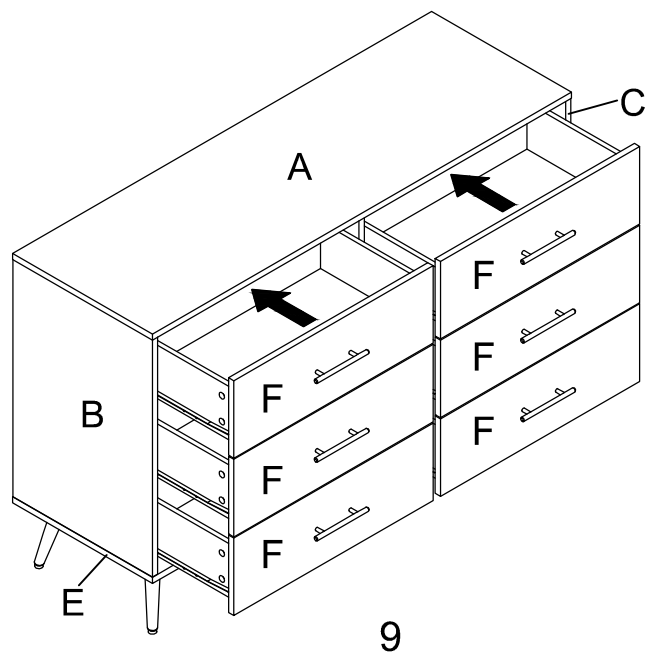

Step 8.

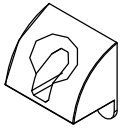

#8 x6





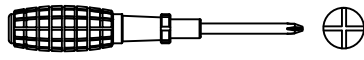

#9 x8

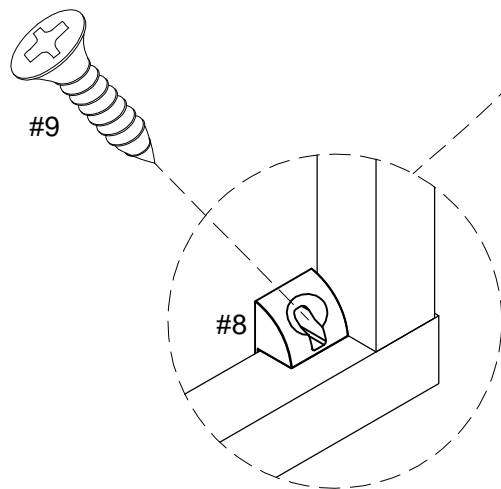
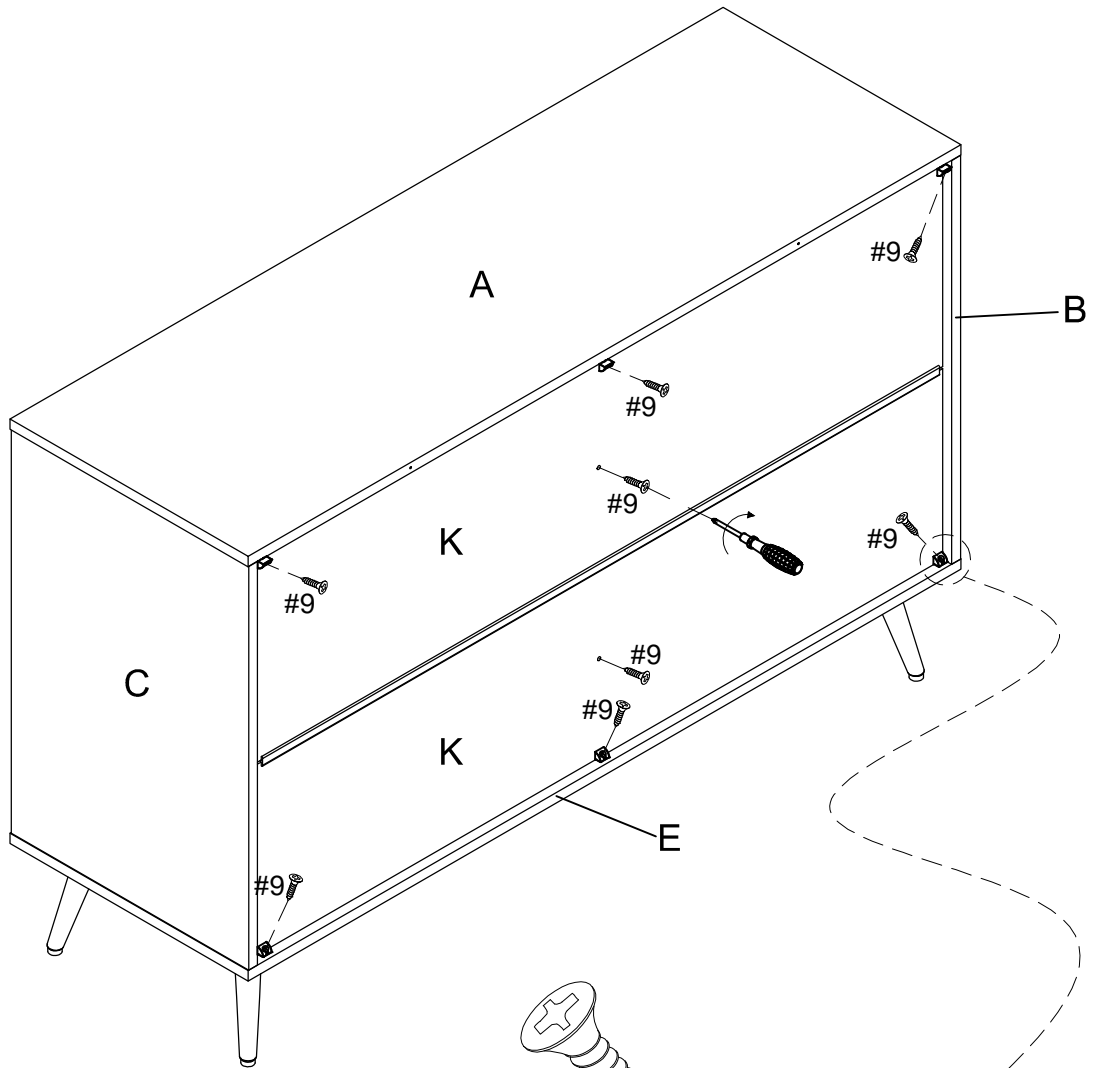

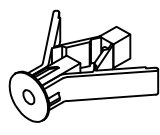
x1

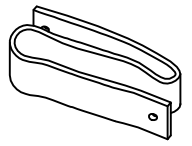

#14 	A 	B 	C  D8*3/4" Short Screw	D  D8*1-1/2" Long Screw	E 
Safety Strap Kit 2 SET	Wall Anchor 2 PCS	Washer 4 PCS	Short Screw 2 PCS	Long Screw 2 PCS	Safety Wall Strap 2 PCS

