

Pure & Easy

ASSEMBLY INSTRUCTIONS

GDOSOS-0021 GDOSOS-0023
GDOSOS-0022 GDOSOS-0024 GDOSOS-0025

HKZJZQN-V1

NOTICE

IMPORTANT, RETAIN FOR FUTURE REFERENCE: READ CAREFULLY
WICHTIG, FÜR SPÄTERE NACHSCHLAGE AUFBEWAHREN: SORGFÄLTIG LESEN
IMPORTANTE, GUARDAR PARA REFERENCIA FUTURA: LEER ATENTAMENTE
IMPORTANTE, CONSERVARE PER RIFERIMENTI FUTURI: LEGGERE ATTENTAMENTE
IMPORTANT, À CONSERVER POUR RÉFÉRENCE FUTURE : LIRE ATTENTIVEMENT

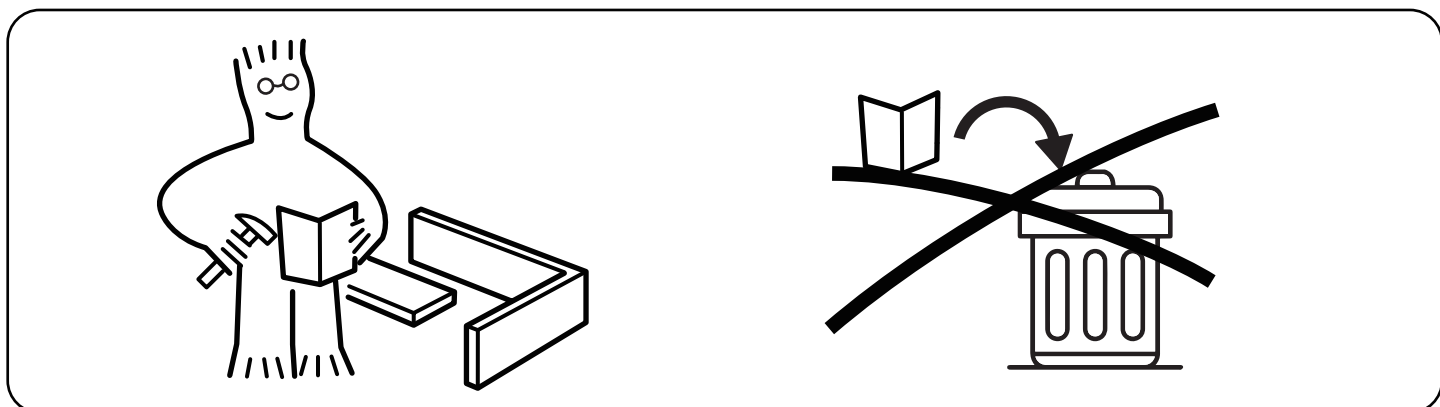

Assemble on a flat, clean and soft surface.
Auf einer flachen, sauberen und weichen Oberfläche zusammenbauen.
Assembler sur une surface plate, propre et douce.
Assemblare su una superficie piatta, pulita e morbida.
Ensamblar sobre una superficie plana, limpia y suave.

Professional installation is highly recommended.
Eine professionelle Installation wird dringend empfohlen.
Une installation professionnelle est fortement recommandée.
Si raccomanda vivamente l'installazione professionale.
Se recomienda altamente la instalación profesional.



Periodically Check That All Components Are Tightly Secured.
Überprüfen Sie Regelmäßig, Dass Alle Komponenten Fest Gesichert Sind.
Vérifiez Périodiquement Que Tous Les Composants Sont Bien Fixés.
Controllare Periodicamente Che Tutti I Componenti Siano Ben Fissati.
Verifique Periódicamente Que Todos Los Componentes Estén Bien Asegurados.





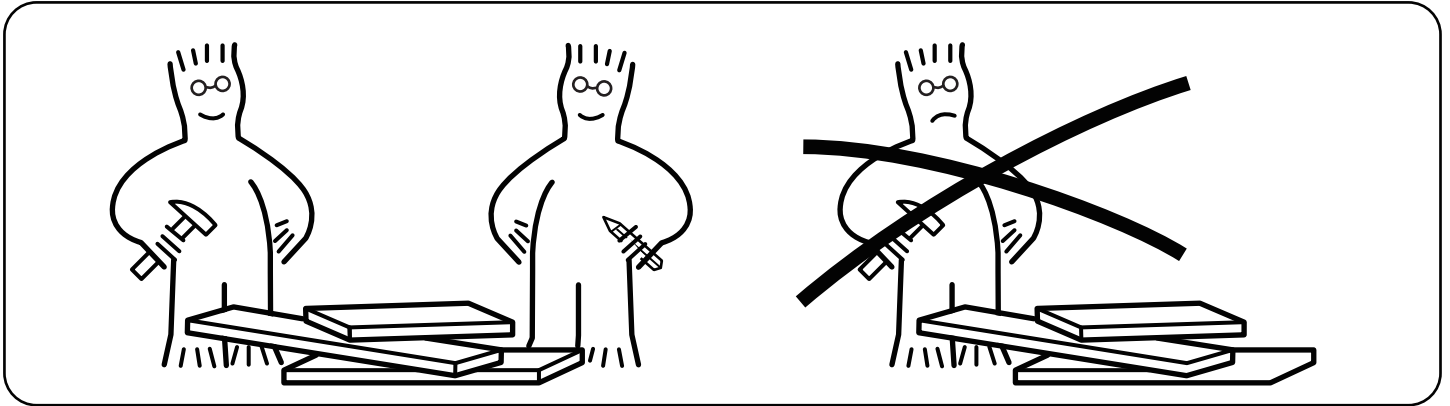



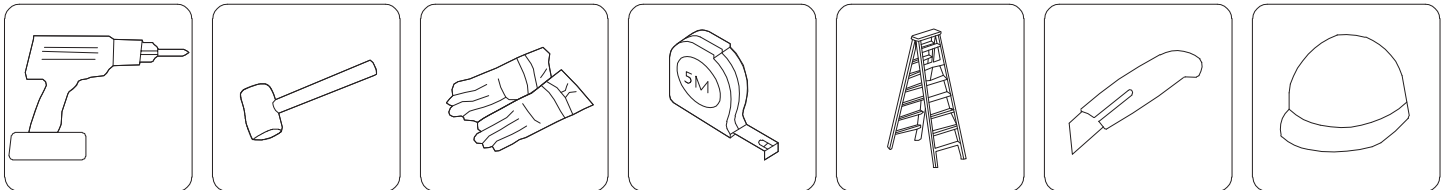

It is recommended that multiple people assemble this product.
Es wird empfohlen, dass mehrere Personen dieses Produkt zusammenbauen.
Il est recommandé que plusieurs personnes assemblent ce produit.
Si raccomanda che più persone assemblino questo prodotto.
Se recomienda que varias personas ensamblen este producto.

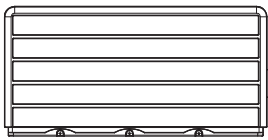
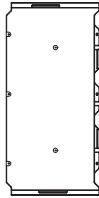
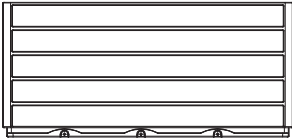

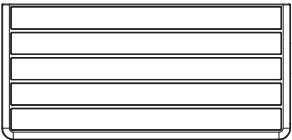
Please have the following auxiliary tools ready:

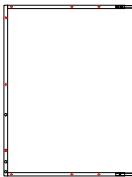

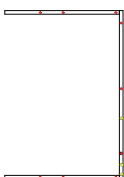
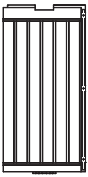
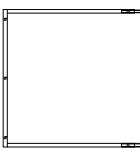
PARTS

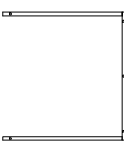
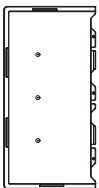
Item no.	Reference Image	Qty.	Item no.	Reference Image	Qty.
A		X1	I		X1
B		X1	J		X1
C		X1	K		X2
D		X1	L		X1
E		X1	M		X1
F		X1	N		X1
G		X1	O		X1
H		X1			

Item no.	Reference Image	Qty.
①		X2
②		X3
③		X1
④		X1
⑤	 M6X12mm	X8

Item no.	Reference Image	Qty.
⑥	 M5X14mm	X42
⑦	 M4X12mm	X8
⑧	 ST5.3X22mm	X16
⑨	 ST5.3X12mm	X14

ASSEMBLY

1



Ⓐ 1pc



Ⓑ 1pc



Ⓚ 2pcs

The seal can be cut according to actual usage conditions.

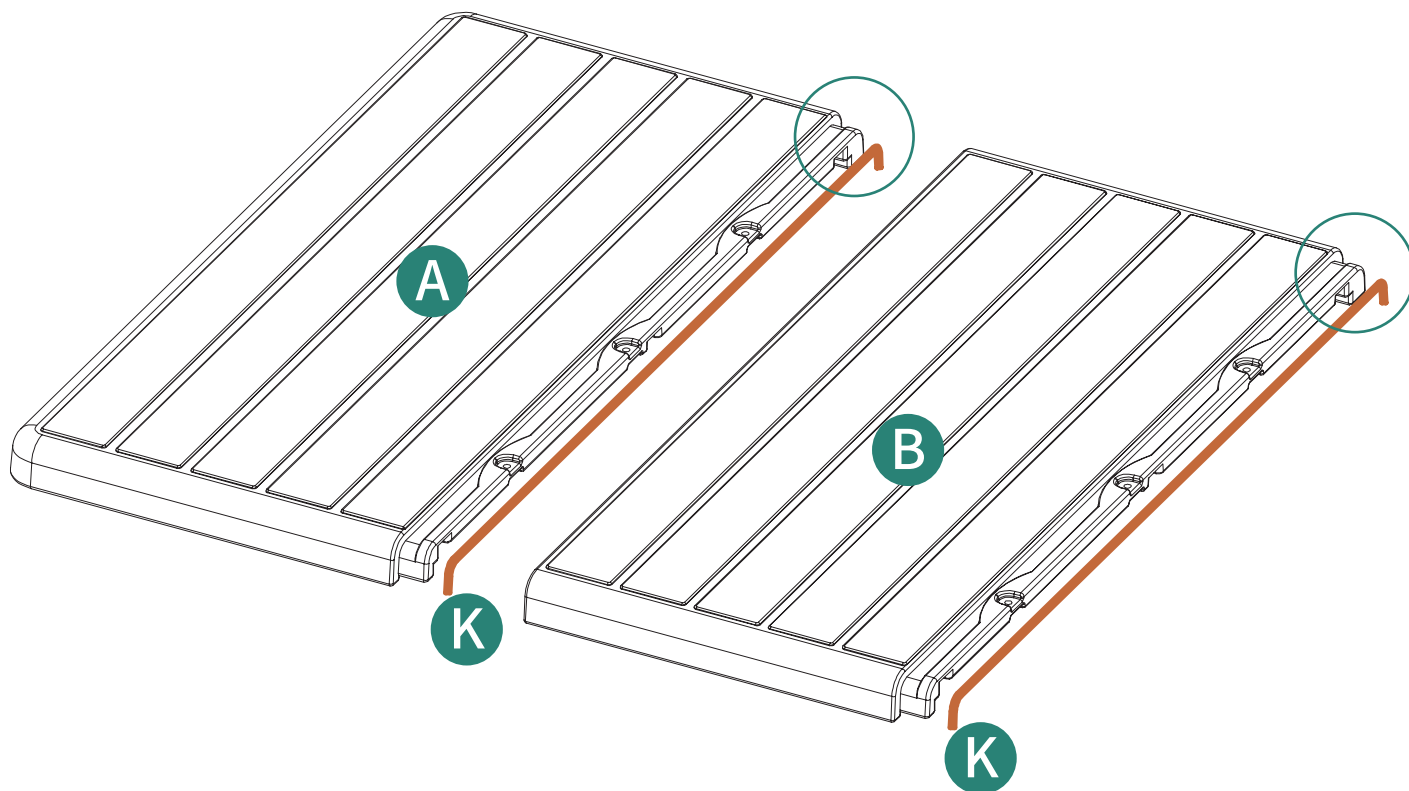
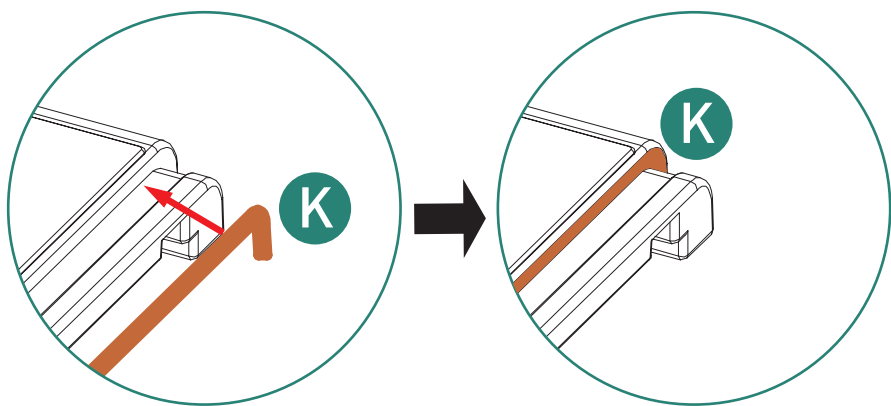

2

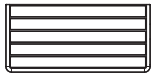

① 1pc

M5X14mm



⑥ 6pcs

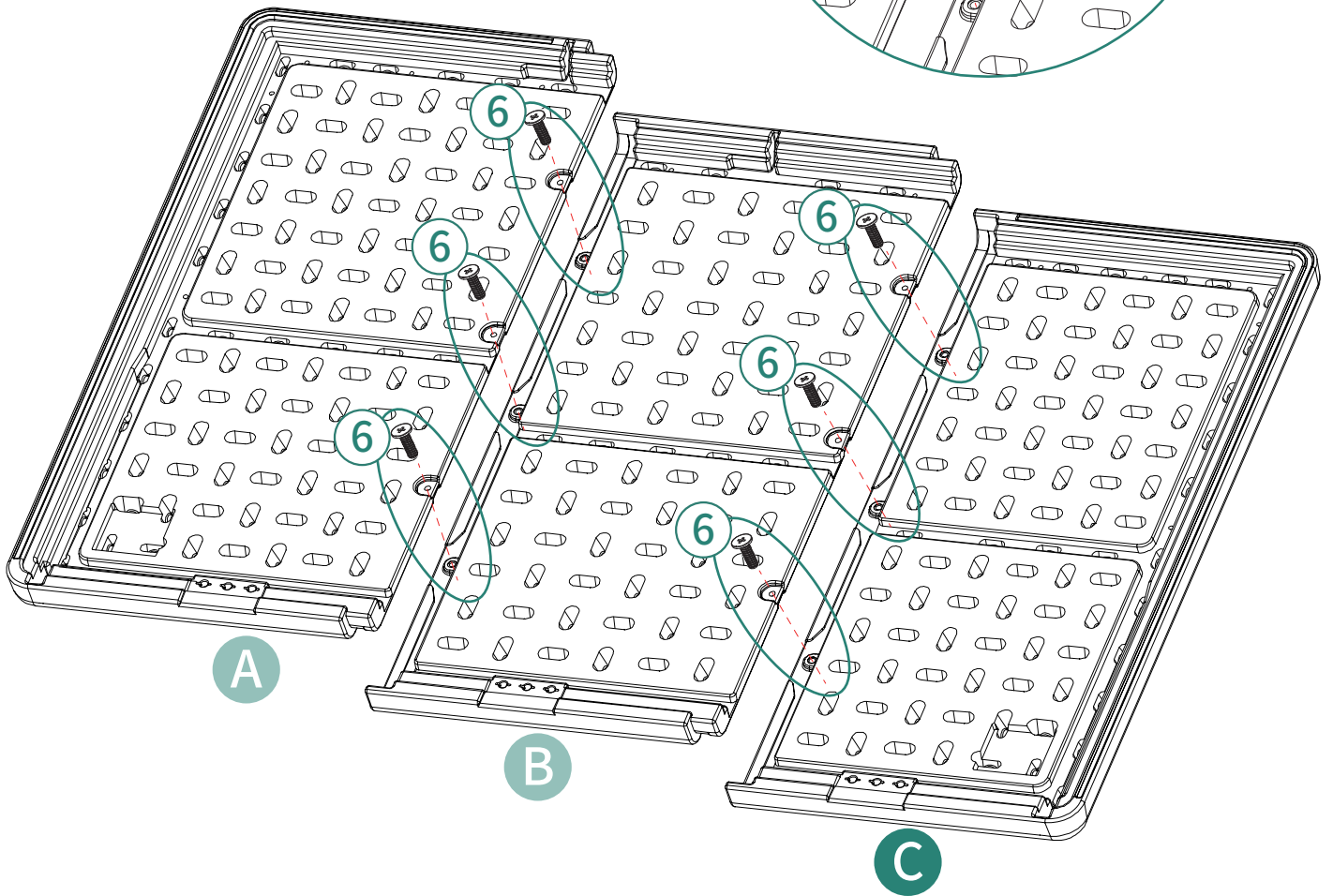
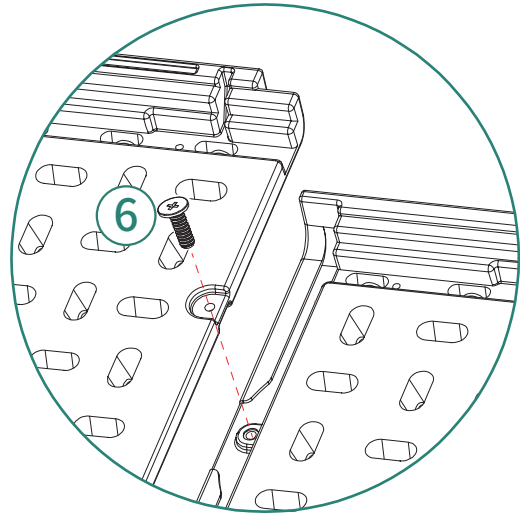

3

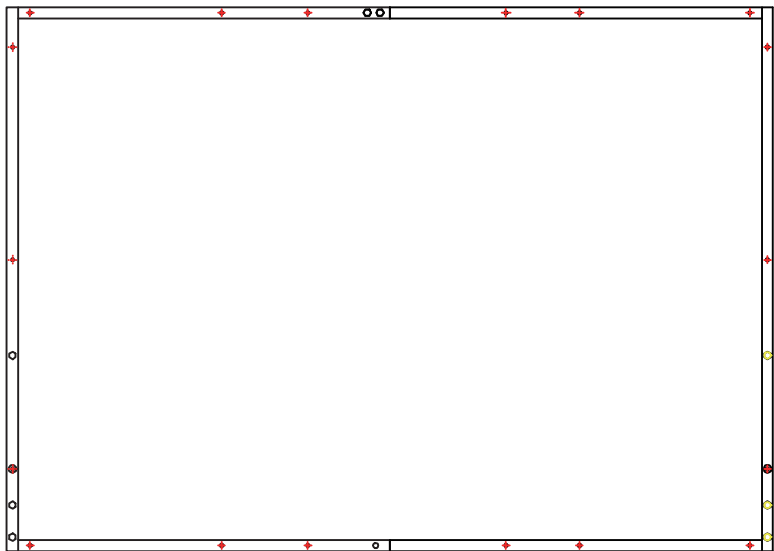
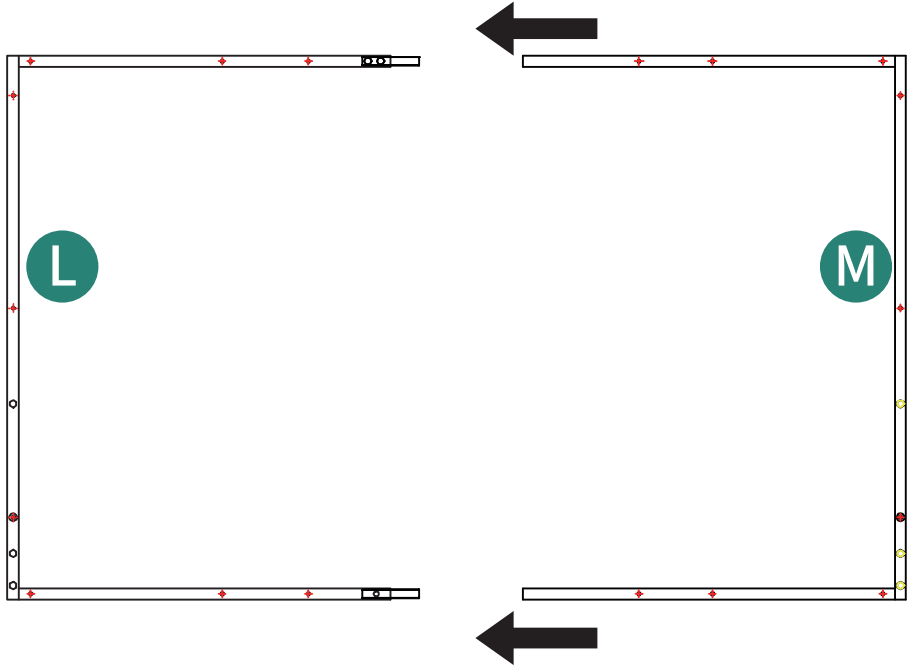
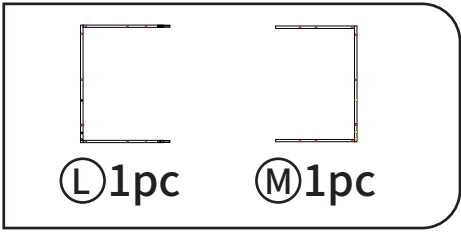

4

ST5.3X22mm

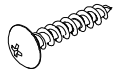

⑧16pcs

ST5.3X12mm



⑨2pcs

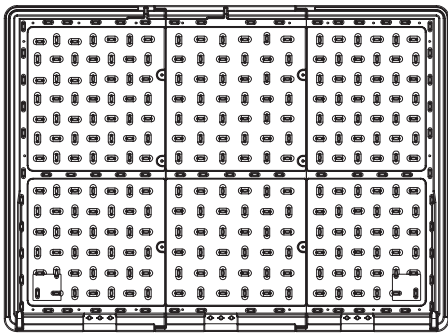
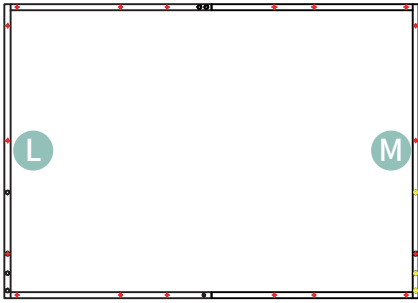

A

B

C

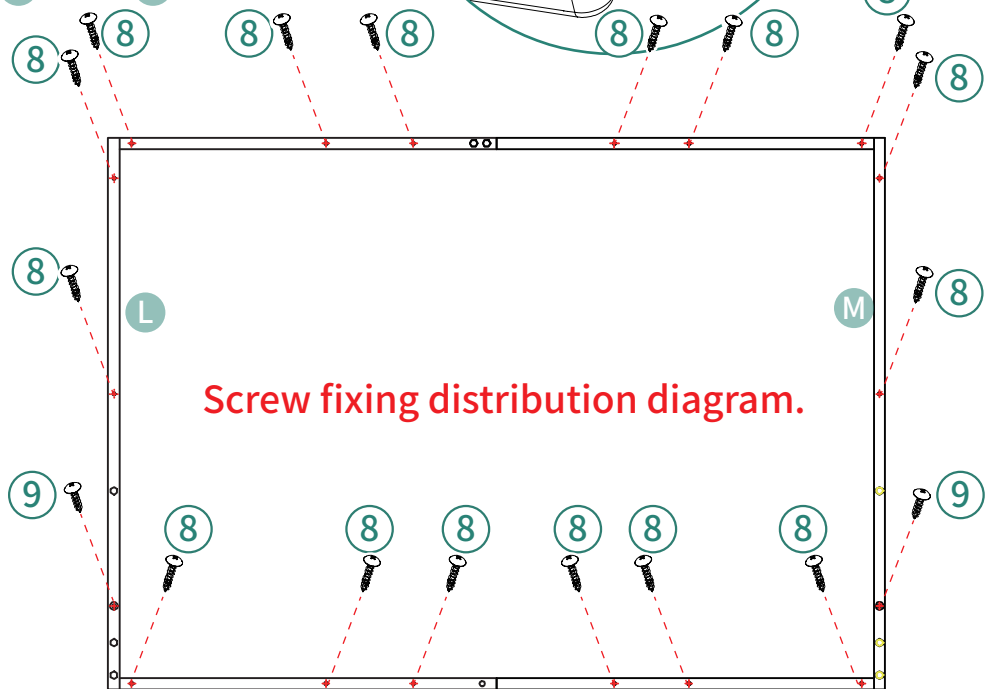
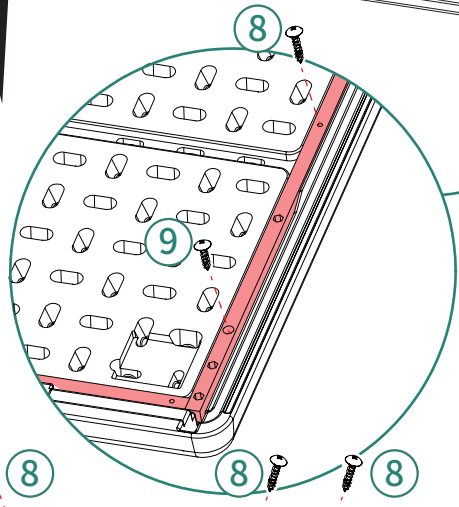
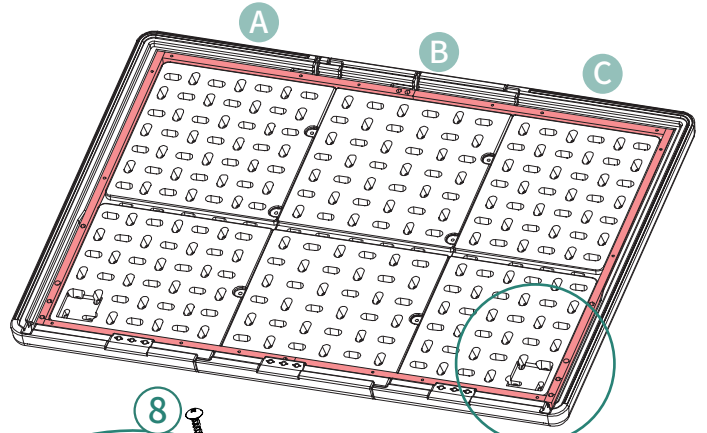

5



Ⓜ H 1pc



Ⓜ I 1pc



Ⓜ J 1pc

M5X14mm



Ⓜ 6 6pcs

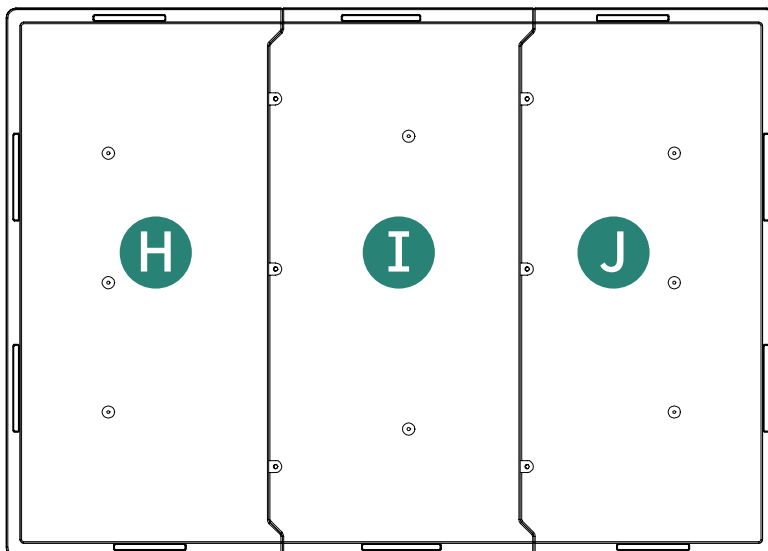
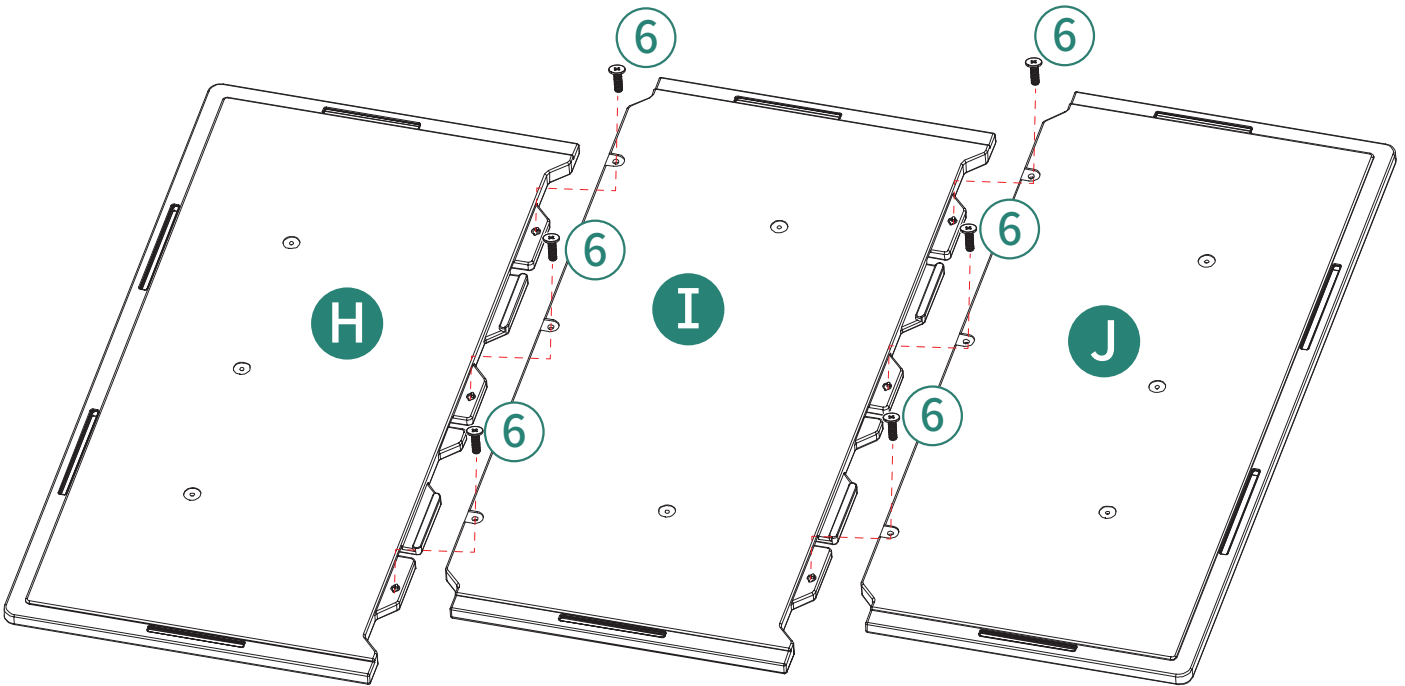

6

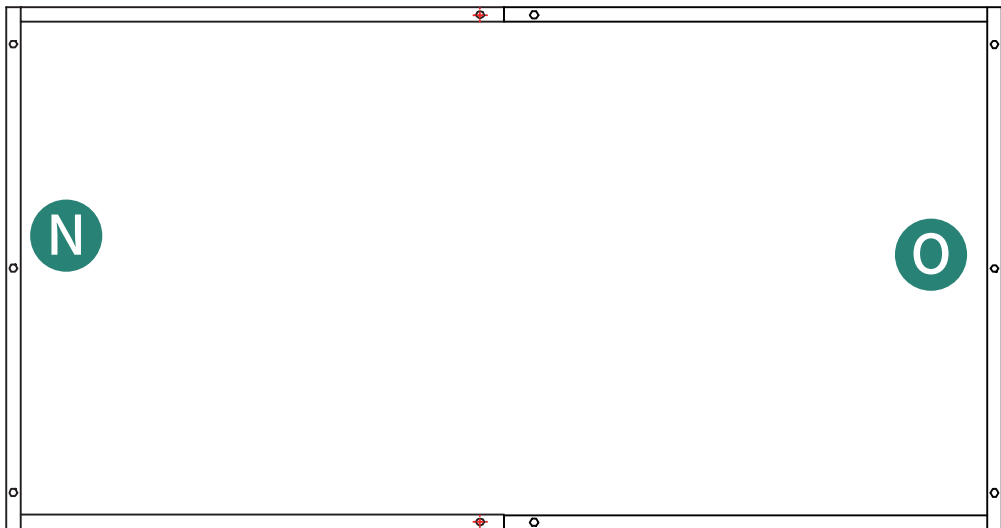
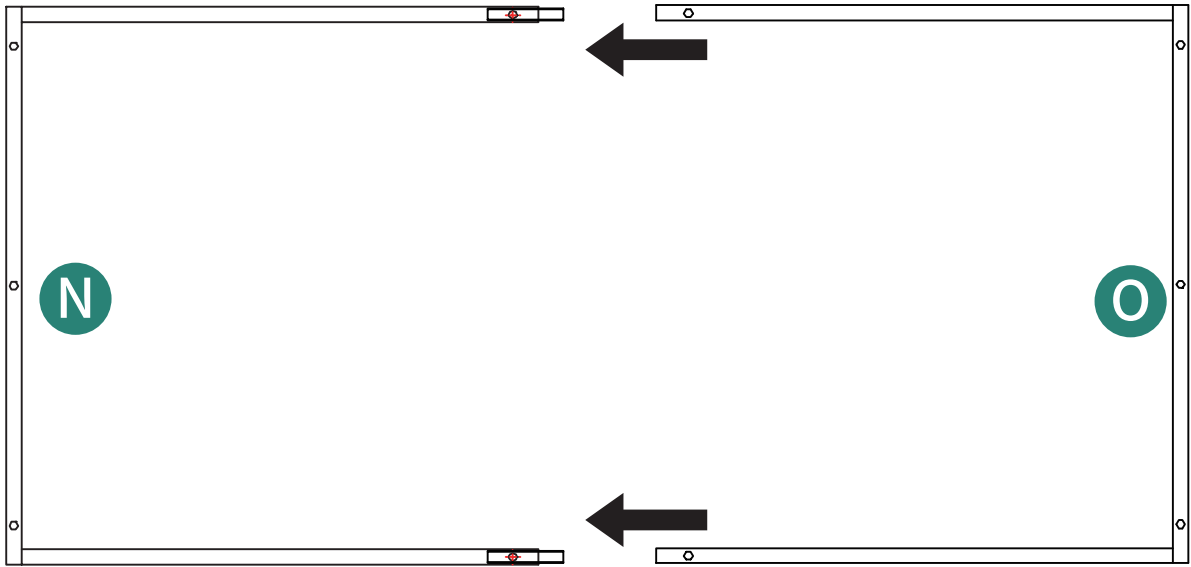
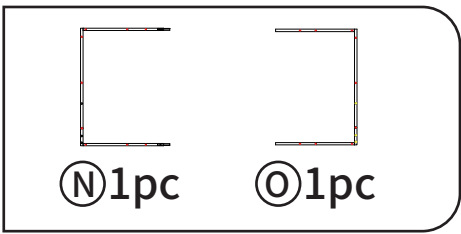

7

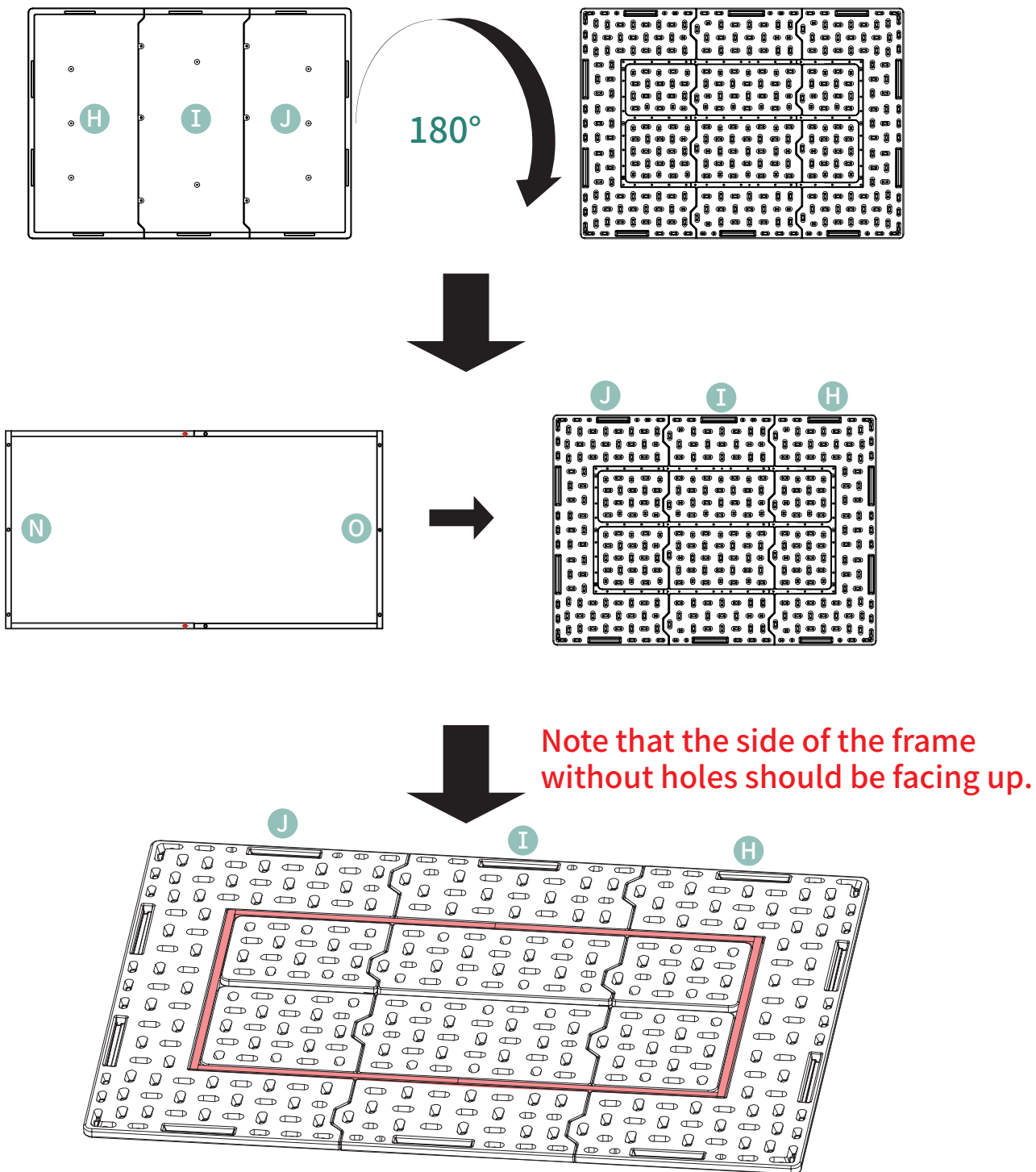

8

M4X12mm



⑦8pcs

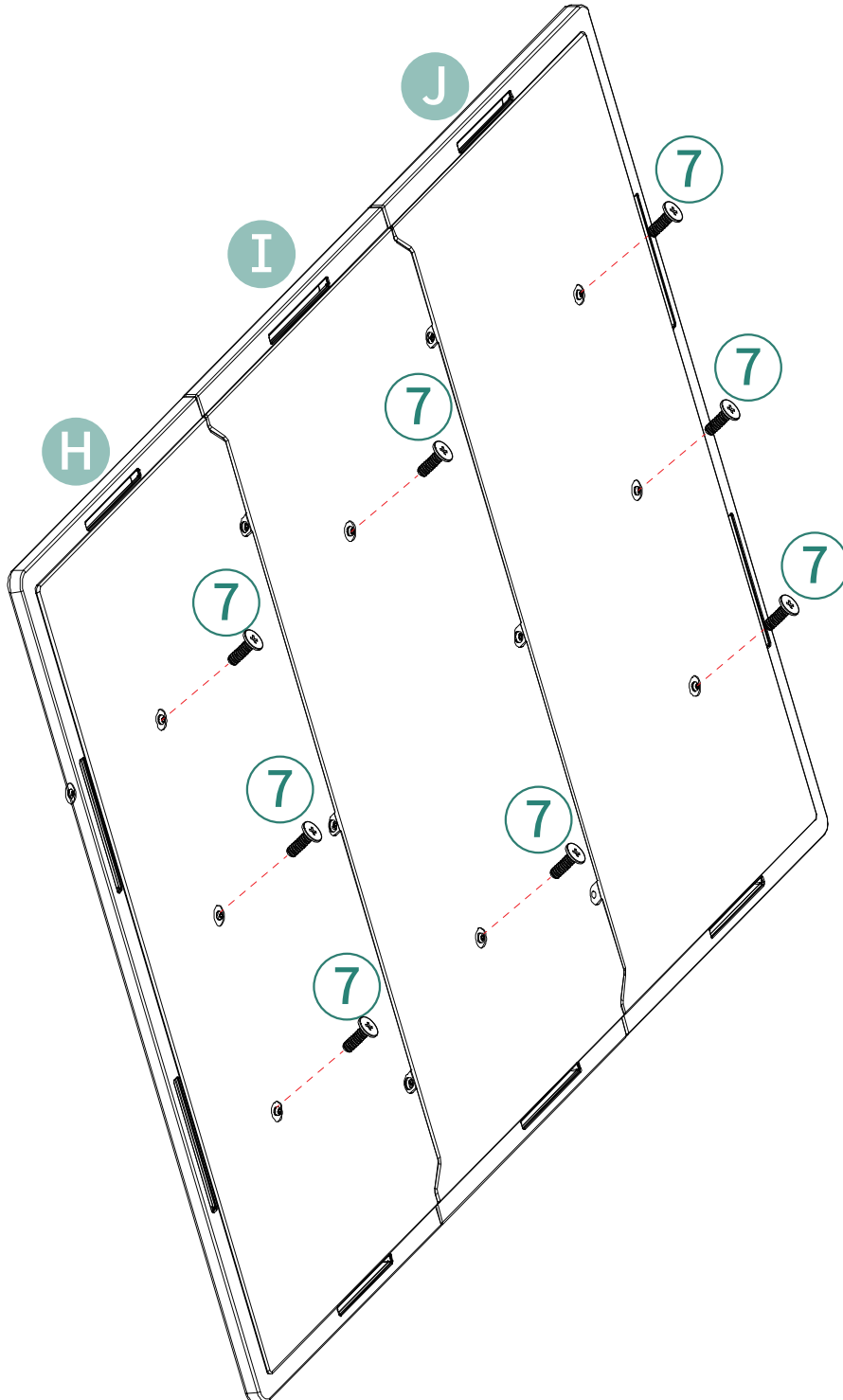

9



ⓓ 1pc

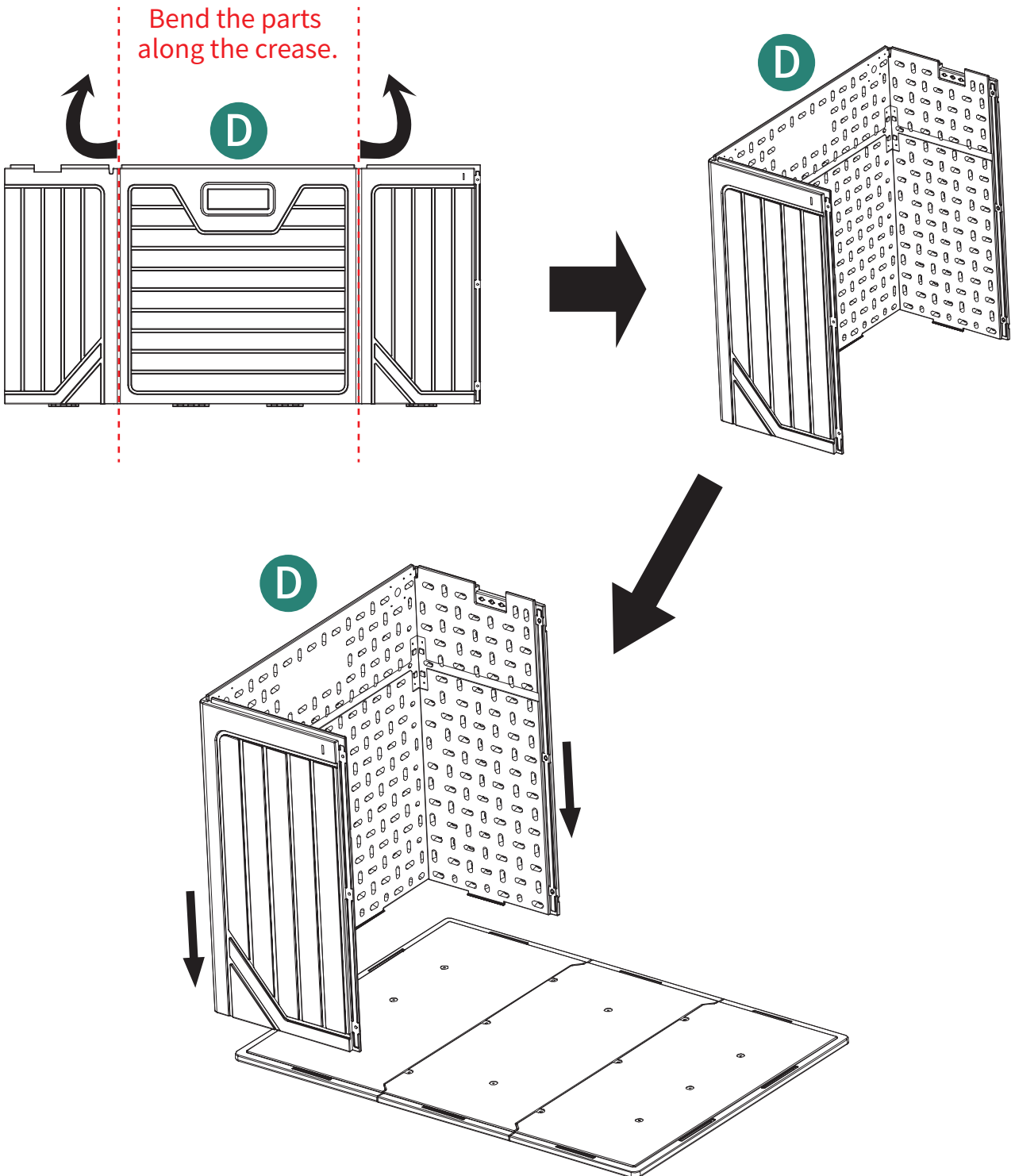

10



F 1pc

M5X14mm



6 3pcs

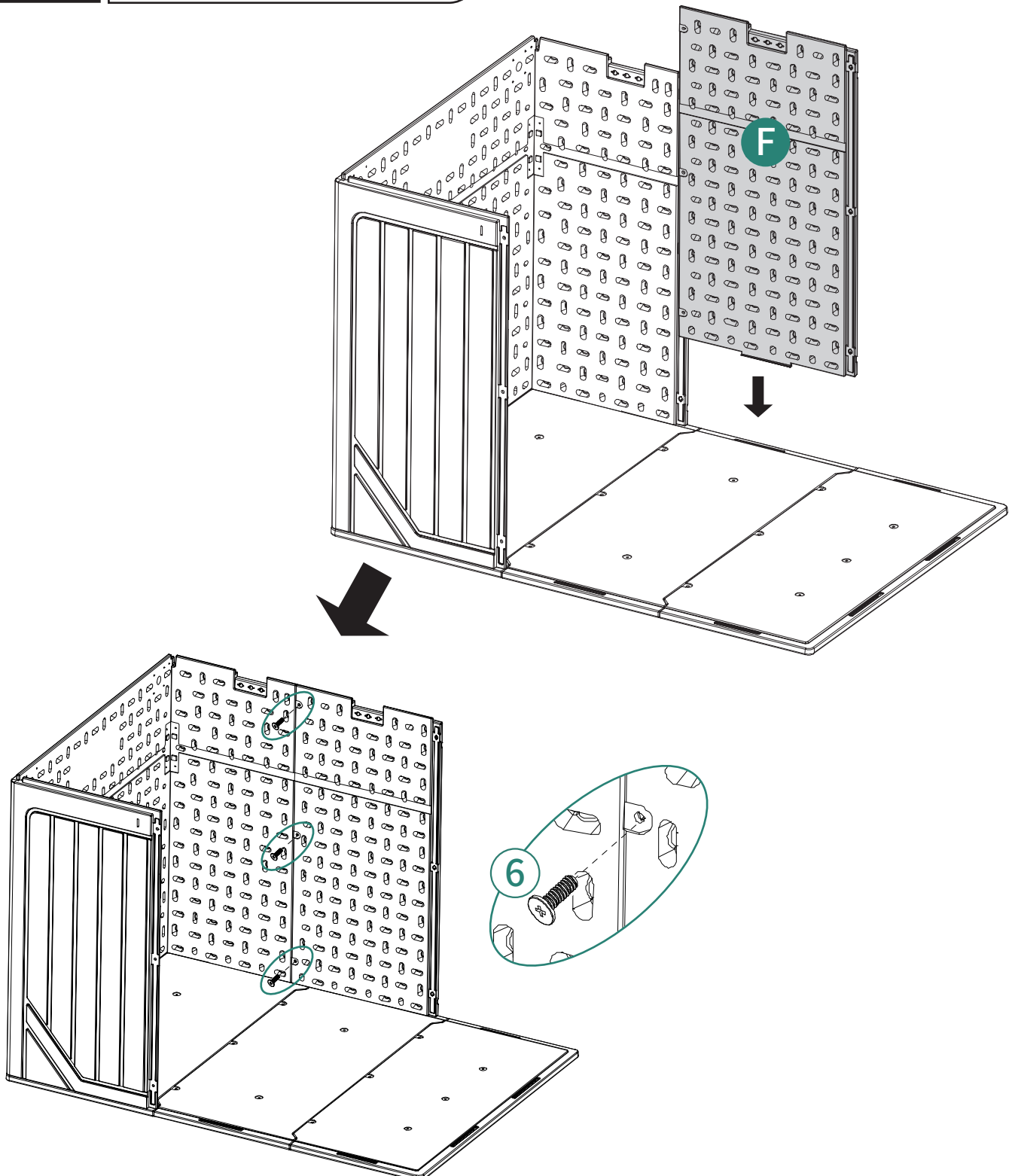

11



©1pc

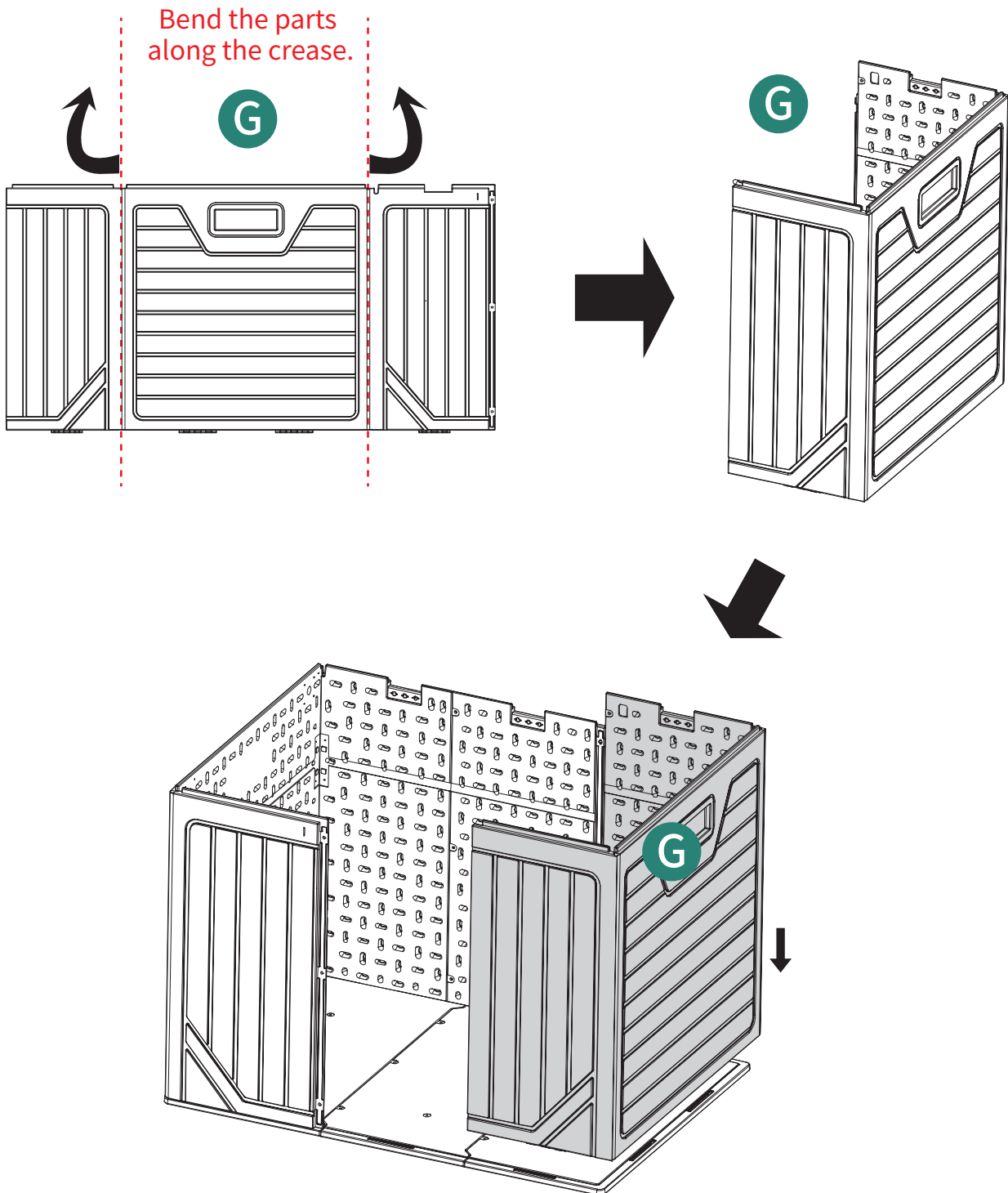

12



Ⓔ 1pc

M5X14mm



Ⓕ 9pcs

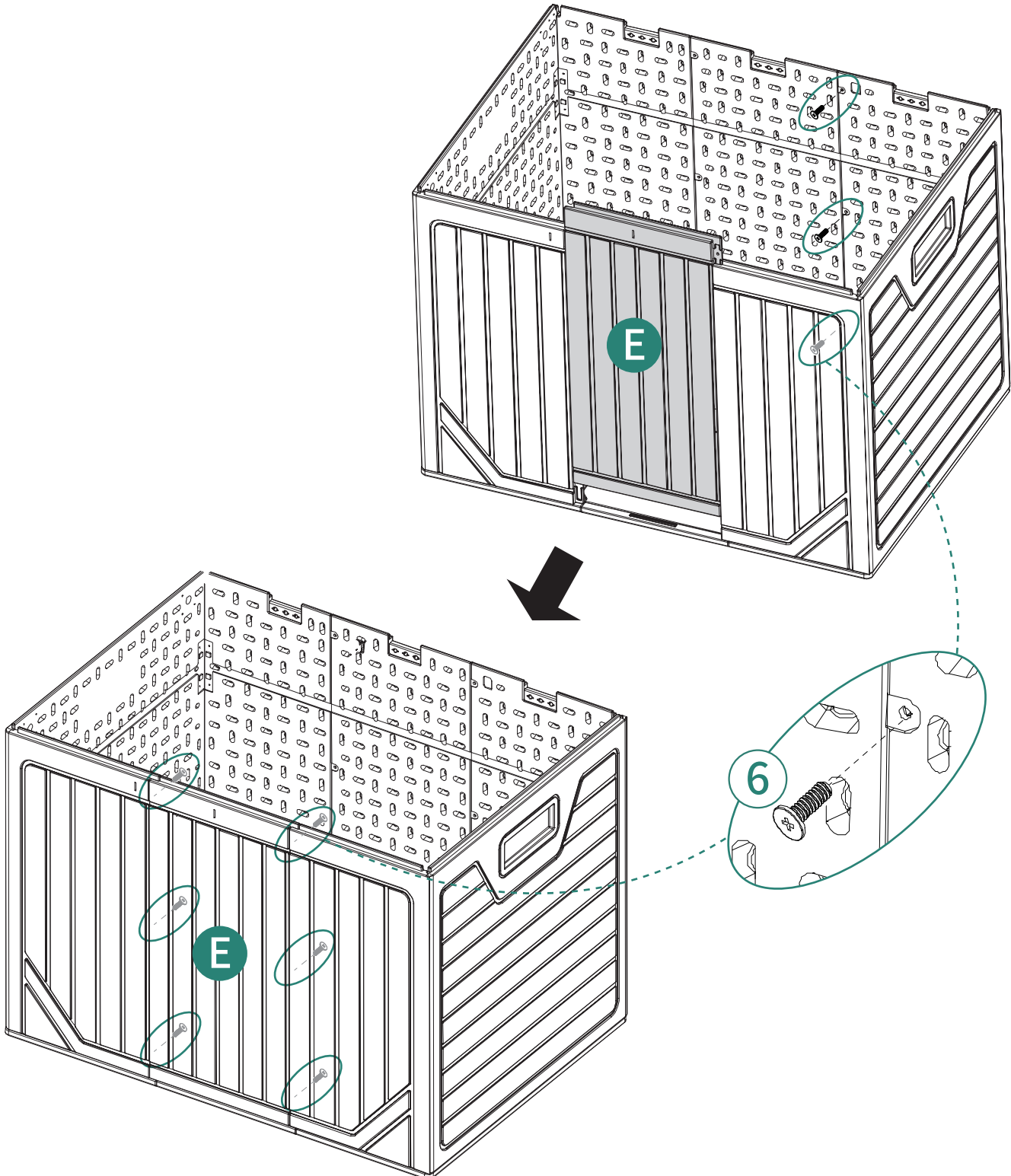

13

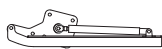

① 2pcs

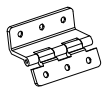

② 3pcs

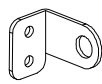

③ 1pc

M5X14mm ST5.3X12mm



⑥ 9pcs



⑨ 12pcs

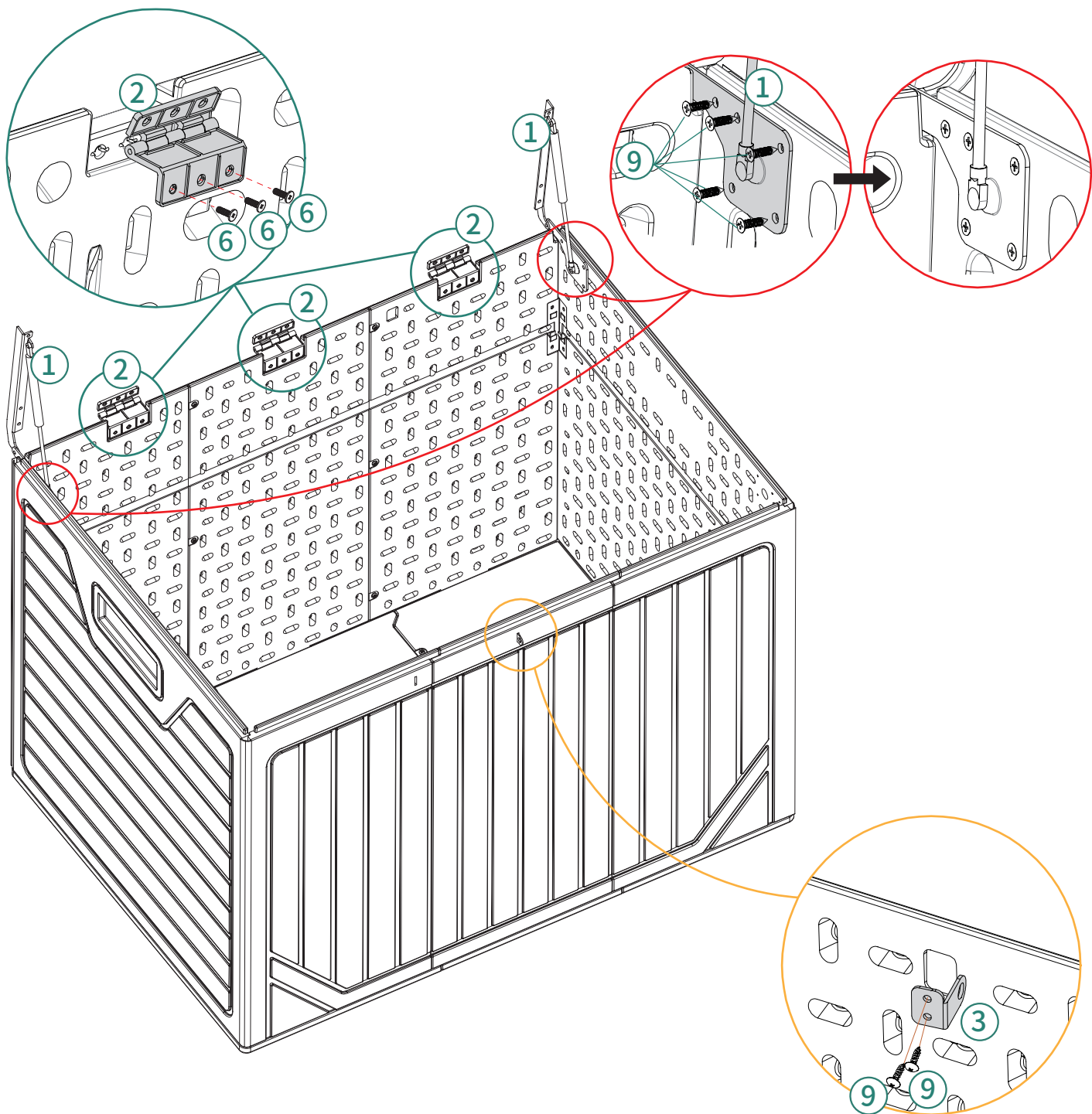

14

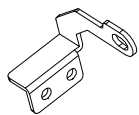

④ 1pc

M6X12mm



⑤ 8pcs

M5X14mm



⑥ 9pcs

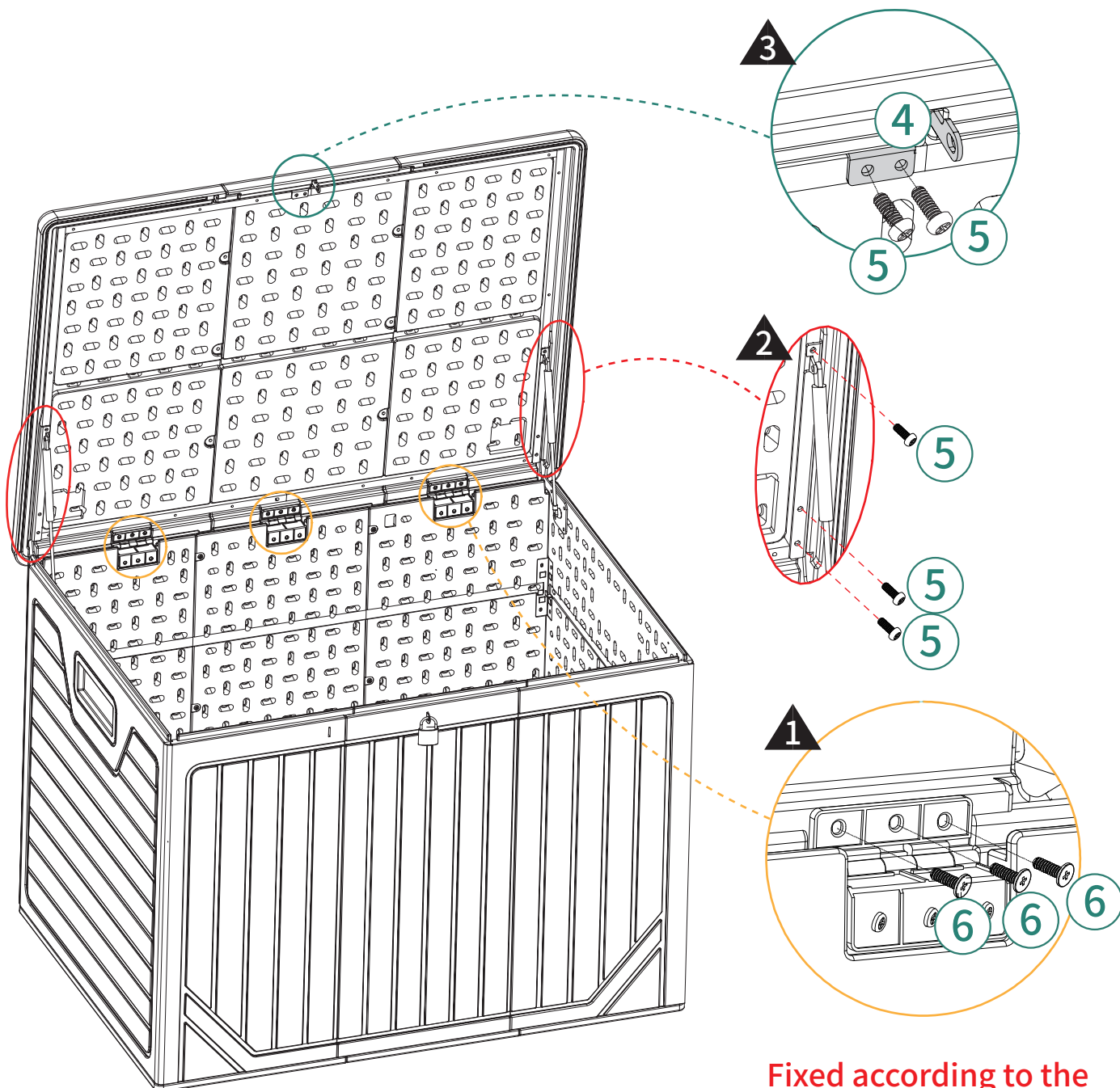

Fixed according to the order of identification.

15

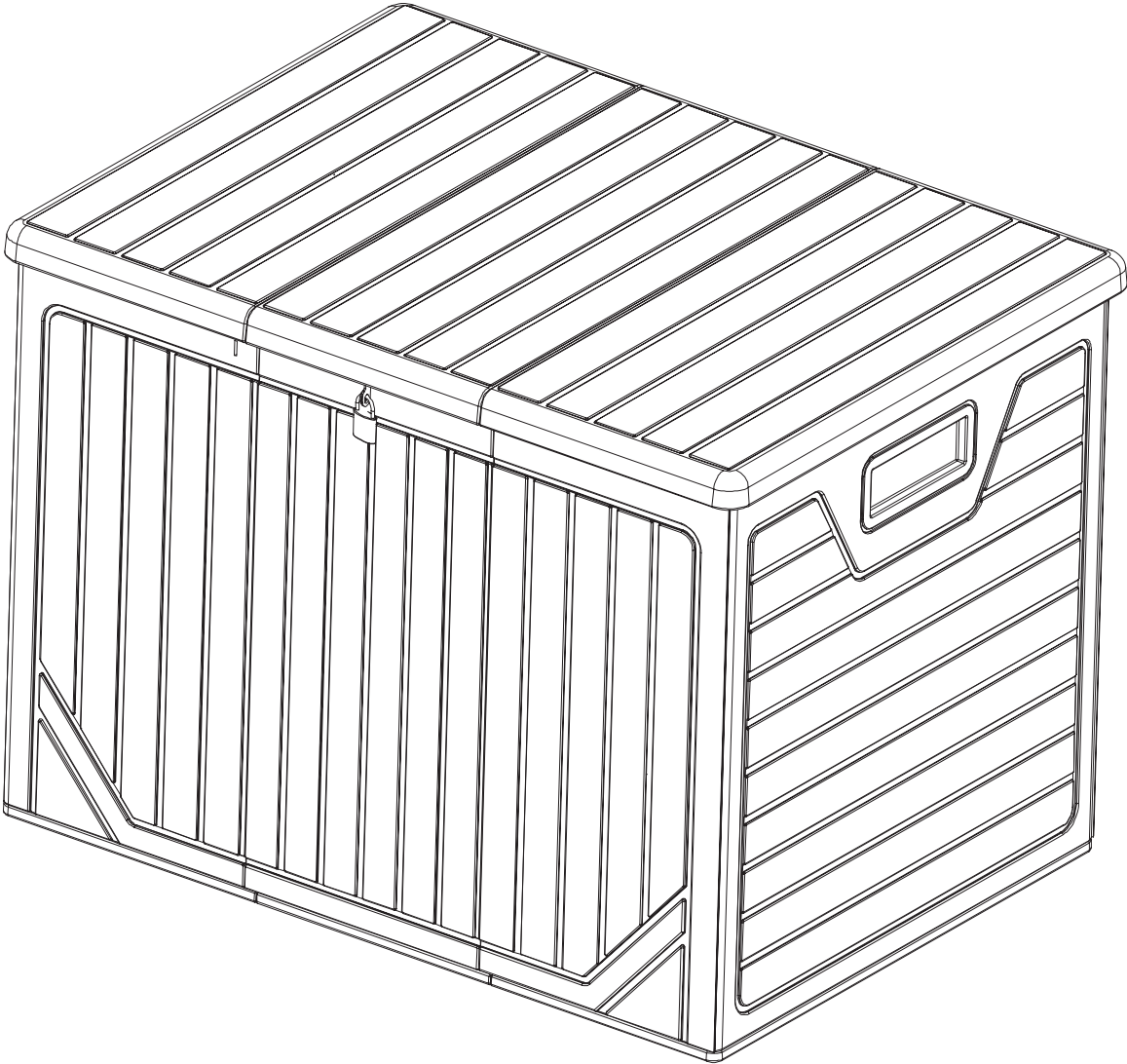

Installation Completed

HELP CENTER



Inquiry



Assembly issue



Missing parts

If you encounter any difficulties during assembly, please contact us.

Wenn Sie während der Montage auf Schwierigkeiten stoßen, kontaktieren Sie uns bitte.

Si vous rencontrez des difficultés lors du montage, veuillez nous contacter.

Se incontri difficoltà durante il montaggio, ti preghiamo di contattarci.

Si encuentras alguna dificultad durante el ensamblaje, por favor contáctanos.

DISCLAIMER

Manufacturer and seller expressly disclaim any and all liability for personal injury, property damage or loss, whether direct, indirect, or incidental, resulting from the incorrect attachment, improper use, inadequate maintenance, unapproved modification, or neglect of this product.

Der Hersteller und Verkäufer lehnen ausdrücklich jegliche Haftung für Personenschäden, Sachschäden oder Verluste ab, egal ob direkt, indirekt oder zufällig, die durch falsche Anbringung, unsachgemäßen Gebrauch, unzureichende Wartung, nicht genehmigte Änderungen oder Vernachlässigung dieses Produkts entstehen.

El fabricante y vendedor renuncian expresamente a toda responsabilidad por lesiones personales, daños materiales o pérdidas, ya sean directos, indirectos o incidentales, derivados de la incorrecta colocación, uso inadecuado, mantenimiento insuficiente, modificación no aprobada o negligencia de este producto.

Il produttore e il venditore declinano espressamente ogni responsabilità per lesioni personali, danni materiali o perdite, dirette, indirette o incidentali, derivanti dall'errato fissaggio, uso improprio, manutenzione inadeguata, modifica non autorizzata o negligenza di questo prodotto.

Le fabricant et le vendeur déclinent expressément toute responsabilité en cas de blessures corporelles, de dommages matériels ou de pertes, qu'ils soient directs, indirects ou accessoires, résultant de la fixation incorrecte, de l'utilisation inappropriée, de l'entretien insuffisant, de la modification non approuvée ou de la négligence de ce produit.