

HOTMASTER™ DIGIHOT Instant Hot Water Appliance Installation, Operation and Care Instructions

DT1F262-XX or
DT1F272-XX



Please read and fully understand this guide to the installation, operation and maintenance for your Instant hot kitchen faucet.

If in doubt contact a qualified plumber or retailer to assist.



Do Not Plug In The Instant Hot Water Tank Until Tank Is Full

For your safety and satisfaction please read all the instructions, cautions and warnings before installing or using this electronic instant hot water appliance.

This electronic instant hot water appliance is not intended for commercial use.

Do not plug in tank until all water connections have been made and checked for being water tight, and the Instant Hot Water Tank must be filled with water.

The Instant Hot Water Tank is filled only when water continually passes out of the faucet spout. For Hot and Cold units, water must pass freely through the hot water side. It is recommended to flush the tank, using several pints of water before operating. This will ensure air is removed from system, and any residual carbon is removed from the filter.

IMPORTANT NOTICE: This product can cause harm if installed incorrectly and should only be installed by a competent person. If you feel for any reason unsure about the installation, please contact a qualified plumber or electrician to install the appliance.

- Make sure all electrical wiring and connections conform to local standards.
- Make sure all water connections conform to local standards.
- Make sure all electrical wiring and water connections conform to local codes.
- Standard 120v electrical outlet is required under the sink.
- If possible, use a separate circuit dedicated to your Hot Tank or use a dual outlet air switch between the tank and the garbage disposal.
- The instant hot water appliance is an open vented system. Water will run out of the spout when the tank is heating to prevent damage or explosions.
- The operating pressure is 22psi to maximum of 72psi.
- The water filter must be connected to the electronic instant hot water appliance and replaced every 6 months or the guarantee will be void.

Tools you may need to install:

Tape Measure, Adjustable Wrench, PTFE Tape, Silicone, Screw Driver, Hack Saw, Tubing Cutter

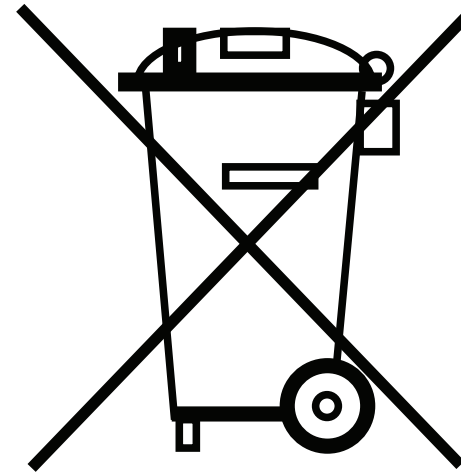
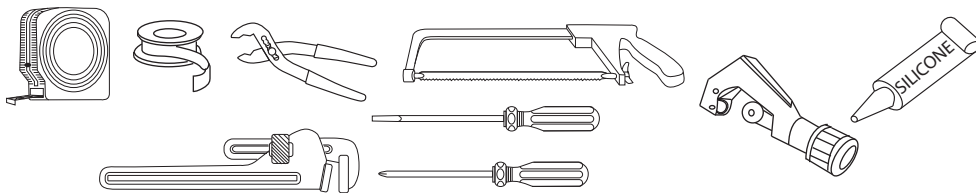

Information on Disposal for Users of Waste Electrical & Electronic Equipment (private households)

This symbol on the product and / or accompanying documents means that used electrical and electronic products should not be mixed with general household waste. For proper treatment, recovery and recycling, please take this product to designated collection points where it will be accepted free of charge.

Alternatively, in some countries you may be able to return your products to your local retailer upon purchase of an equivalent new product.

Disposing of this product correctly will help save valuable resources and prevent any potential negative effects on human health and the environment, which could otherwise arise from inappropriate waste handling.

Please contact your local authority for further details of your nearest designated collection point.

Penalties may be applicable for incorrect disposal of this waste, in accordance with your national legislation.

For business users in the European Union

If you wish to discard electrical and electronic equipment, please contact your dealer or supplier for further information.

Information on Disposal in other Countries outside the European Union

This symbol is only valid in the European Union. If you wish to discard this product please contact your local authorities or dealer and ask for the correct method of disposal.

TROUBLE SHOOTING GUIDE

| PROBLEM | POSSIBLE CAUSE | WHAT TO DO |
|----------------------------------|--|---|
| Slow Flow from the spout | Water Filter may be clogged from impurities from the inlet water. | The water filter must be changed every 6 months or this will void the warranty. Change the filter. |
| Water does not flow immediately. | The electronic instant hot water appliance is design for non-pressurised operation and there will be slight delay till the nearly boiling water appears. | After a large volume of water has been drawn off, it might take slightly longer for the water to appear from the spout. |
| No water flowing. | Water valves have been turned off. Inlet pipes have been twisted or blocked. | Turn on all the water valves. Ensure the pipes are not twisted or kinked to restrict flow. Remove the electronic instant hot water appliance as per the de-scaling instructions and flush through all pipes to ensure water flow. |

CARE & MAINTENANCE

With the exception of living finishes, all Westbrass decorative finishes are protected by the strongest finish treatments available while maintaining their luxurious appearance. While some finishes are more durable than others, no finish is indestructible. Polished Chrome, Satin Nickel and PVD Polished Brass finishes are the most durable. All other finishes are electroplated; some are then coated to enhance the gloss and durability.

TO CLEAN:

Do not allow your product to come into contact with any cleansers fortified with ammonia, bleach, grease-cutters or other surfactant chemicals. Soft Scrub, Dawn Liquid Soap, Palmolive or any other combined cleaners contain certain chemical components that will dissolve and remove the finish's protective coating, and eventually the finish itself. Use only plain warm water and mild soap on a soft cloth or sponge. Avoid using any sponge with a scouring pad to clean your product. It is not necessary to rub hard to remove spots.

TO PROTECT:

An occasional application of Carnauba wax (without cleaners), like that found in Flitz Faucet Wax, Turtle Wax for Clear Coat Car Finishes or McGuire's Premium Wax, will enhance the finish lustre, reduce hard water spots and add an extra layer of protection to your finish.

WARRANTY

Finishes:

All sink and tub/shower drains, strainers and other trims have a 1 year warranty

Functional Warranty:

The functionality of all products is warranted for a period of one year. Ceramic disc valves on any water delivery merchandise are warranted for one year. Warranties are guaranteed to the original purchaser only. Product problems attributable to abuse, misuse, improper installation, hard water, neglected maintenance or accidental damage are not covered by this warranty. Modifying the product in any way voids the warranty. The use of plumber's putty on our products also voids the warranty. Silicone

sealing compounds should be used instead. No repairs or replacements will be made under such circumstances except at customer's expense. Liability under warranties expressed or implied is limited to repair or replacement of defective goods only. In no event will Westbrass be liable for incidental or consequential damages (such as labor charges). This warranty does not cover labor charges, whether based on breach of express or implied warranty, breach of contract, negligence or any other legal theory.

SAFETY INSTRUCTIONS

The alert symbols displayed on the right points to important safety information to make you aware of potential hazards that can cause serious injury or death. Please pay special attention to the information following these warning alerts. Failure to comply with these instructions could result in property damage, serious injury or death.



Electric Shock:

Using an ungrounded connection or improper connection of the power supply to the product can result in a serious injury or death from electrical shock.

- Do not remove the ground terminal
- Do not alter the plug
- Do not disassemble main box and any part of the power.



Important:

The instructions are only intended as a guide for a knowledgeable individual. If there is any doubt, please contact a certified plumber or electrician or point of purchase agent and avoid using the appliance until it has been checked.

INCLUDED COMPONENTS

The electronic instant hot water appliance is supplied with the following:

- Electronic Instant Hot Water Appliance with USA IEC power lead.
- 3/8 inch NPSM x 1/4 inch insert fitting and clamp*
- 3/8 inch NPSM x 5/16 inch insert tank inlet fitting*
- ShokBlok faucet and filter protection unit
- F400 filter unit, mounting head and cartridge
- D262-NL-XX or D272-NL-XX Instant hot/cold faucet

* The water connections are to allow correct connections from the instant hot water tap to the electronic instant hot water appliance. Tank Inlets are 3/8 inch Nation Pipe Straight Swivel.

Also required, food grade cold water supply lines in 3/8" copper or PVC insert fittings. Tee or some other type of cold water supply to the system.

Note: HANDLE SHOULD BE BEHIND THE SPOUT. THE HANDLE CURVE MUST PUSH AWAY FROM THE SPOUT FOR PROPER HANDLE OPERATION AND TO PREVENT SERIOUS BURNS.

IMPORTANT SAFETY INSTRUCTIONS

PLEASE READ ALL INSTRUCTIONS CAREFULLY



When using all electrical appliances, basic safety precautions should always be followed including the information below:

To protect against electrical shock, do not place cord, plugs or unit near or in water or other liquids and do not operate the electronic instant hot water appliance controls or power socket with wet hands.

Check the power rating of your electronic instant hot water appliance is suitable for the power rating of the electrical circuit it is being installed on.

Do not operate or install the electronic instant hot water appliance if it appears to have any missing parts, be damaged /faulty e.g. damaged cord, plug.

Do not use outdoors or in a damp area.

Do not use the electronic instant hot water appliance for anything other than the intended Domestic use only.

The electronic instant hot water appliance must be installed vertically as shown on front cover with inlet and outlet connections at the top of appliance. Ensure the front of the unit is visible and the front temperature dial can be easily reached.

Do not attempt to open, modify or service this electronic instant hot water appliance. Repairs should be carried out by Authorised Service personnel. Opening the unit will void the guarantee.

The instant hot water appliance is an open vented system appliance. It will leak out of the spout when unit is reheating to prevent property damage or explosions.

Turn off all controls before unplugging.

Do not unplug by pulling the cable. To unplug, grasp the plug, not the cable.

Property Damage: To avoid the risk of flooding, regularly inspect the connections for any signs of leakage.

This electronic instant water appliance is not intended for use by persons (including children) with reduced physical, sensory or mental capabilities, or lack of experience and knowledge, unless they have been given supervision or instruction concerning use of the appliance by a person responsible for their safety. Children should be supervised to ensure that they do not play with the electronic instant hot water appliance or instant hot water tap, a safety spring back handle is used to control the flow of the near boiling water for additional safety.

TROUBLE SHOOTING GUIDE

| PROBLEM | POSSIBLE CAUSE | WHAT TO DO |
|--|---|---|
| Water and Steam is spitting from the instant hot water tap spout | Unit is boiling | Turn the instant hot water tap handle on and release the water. Adjust the water temperature on the display to a lower setting. Check aerator is not blocked Bleed system to remove any air Re-Prime bladder to allow correct operation. |
| Water is not hot. | The electronic instant hot water appliance is unplugged. The electronic display has not been powered up. | Make sure the electronic instant hot water appliance is plugged in and connected to a grounded electric outlet. Make sure that the circuit breaker and fuse are working correctly. Turn on the power and touch the on/off button and then set the required temperature and confirm the heat up. |
| Water is too hot. | Water temperature setting on display panel is set too high. | Re-set the temperature indicator to the required temperature and confirm heating. Draw off 1 pint of water to clear and prime the system. Avoid less than 1/3 of a pint draw off of water. |
| Water is dripping from the instant hot water tap spout. | The expansion chamber isn't draining the system correctly due to very small draw off of water. The spout is blocked. | Check silicon pipe length. Too long a length can affect performance. Remove and clean the aerator if present. |

MAINTENANCE AND CARE INSTRUCTIONS

Flushing the Instant Hot Water Tank

It is recommended that the user flushes through the system completely by drawing off all of the hot water and allowing the tank to refill, and repeating the process for a further 2 or 3 times to ensure the system is fully operational.

Should you require any advice on the installation then please seek guidance from your the instant hot water and allowing to reheat Retailer or a Qualified Plumber.

Water Draw Back and Contamination in the Tank

During the filling of any vessel the user must ensure at all times that the spout outlet is not submerged in the water during the dispensing of the instant hot water; especially when the instant hot water handle is released.

Maintenance & Power Saving

If the electronic instant hot water appliance is not being used for long periods of time ie: over 2 days, to save power we recommend you switch off using the "ON/OFF" switch.

Seasonal Shutdown

The hot water system (tank and tap) must not be exposed to freezing temperatures. If there is a possibility of this, the system must be drained of water. Shut-off the main water supply and unplug the unit from the electrical box. Allow the tank to cool for at least 1 hour. Disconnect the inlet supply to the tank and remove the silicone hose outlet pipe. Put a bucket under the sink and open the handle to allow to drain. Lift the tank to the sink, turn upside down and drain all the water from the tank. When reinstalling, follow the original installation instructions.

NOTICE

The electronic instant hot water appliance like any water heater has a limited operational life span and will eventually fail. In order to ensure maximum protection and to avoid possible damage to any property or personal injury the electronic instant hot water appliance should be inspected regularly for any water leakage or damage. Regularly check for any signs of water leakage. If there is any water leakage then replace any loose or split silicon tubes or pipes which can cause water leakage and damage.

To provide additional water security to avoid property damage the electronic instant hot water appliance can be placed in a drain pan and connected to a suitable drain outlet to avoid any water damage. The drain pan should be installed using the manufacturer's installation instructions.

INSTALLATION REQUIREMENTS

Electrical Requirements

A 120 volt, 60 Hz 15 amp fused, grounded electrical power supply is required. It is recommended that a separate circuit serving only your electronic instant hot water appliance be provided or use an outlet that can be turned on/off by a disposal switch. This electronic instant hot water appliance is equipped with a power supply cord with a power plug. To minimise possible shock hazard, the cord must be plugged into a mating, ground-type outlet, grounded in accordance with all national and local codes and ordinances. If a socket outlet is not available, it is the responsibility and obligation of the customer to have a properly grounded outlet installed by a qualified electrician.

Water Supply Requirements

If local codes permit, the instant hot water inlet should be connected to the cold water supply line using an isolation valve or another means for providing cold water to the tap.

IMPORTANT: If local codes do not permit the use of isolation valves, special feed valves can be obtained from your local plumbing supply distributor. If the water is mixed with impurity, ironing chips, grains of sand, and so on, the pipes of the electronic instant hot water appliance and tap will be blocked and will void the warranty.

Environment requirement

Don't install the electronic instant hot water appliance outdoors or in a location that may fall below zero degrees C, otherwise the pipes and the tap and tank will be frozen and their can be serious safety issues, possible bodily-injury, accidents and property damaged which will void the warranty.

Do not wash the electronic instant hot water appliance with water directly.

The installation environment should be ventilated, with protection from the direct sunshine. When installing the electronic instant hot water appliance, provide approximately 10cm to 15cm (4" - 6") of air space on the sides of the unit for air circulation and approximately 2.5cm (1") in front. The humidity levels should be in the range of 10% to 60%.

Instant Hot Water Tap Information

Connecting a standard faucet may cause injury and will damage the electronic instant hot water appliance and void the warranty. Due to high water temperature, and for safety reasons, the electronic instant hot water appliance is not under pressure. This unit is only for Instant Hot Water Dispensers using a Vented System.

Instant Hot Water Appliance Temperature Adjustment

For temperatures above 208 F. This unit has been set for optimum performance in most common and typical known installations. However there are factors which may influence the performance of the instant hot water appliance such as incoming water temperature, atmospheric pressure and altitude. Should you experience any discharge of water from the spout during heat up, you can reduce the setting to compensate for this by 3 - 6 F degrees. If in doubt please ask your dealer for further guidance.

PREPARATION FOR INSTALLATION

Unlike other household hot water appliances, this electronic instant hot water appliance is **Non-pressurised** for safety reasons. For this instant hot water appliance, the faucet is placed between the incoming water and the tank. Water enters the tank only when the faucet is activated. The incoming water pressure forces the Hot Water up through the rubber hose causing it to dispense hot water. This forms the, "Open vent system," and consequently, no pressure is built up inside the tank.

IMPORTANT: Install the Instant Hot Water Appliance in accordance with the instructions provided with the Hot Water Unit.

Preparation for the electronic instant hot water appliance installation

IMPORTANT: Observe all local governing codes and ordinances. The electronic instant hot water appliance must be mounted vertically and level.

Before you begin, select a proper location ideally directly under the instant hot water tap or close to it to ensure the connection pipes will connect from the instant hot water tap to the electronic instant hot water appliance.

The electronic instant hot water appliance is not under pressure, consequently, there is a slight delay in water flow after the hot water spring back tap handle has been turned on. This is normal and indicates that the electronic instant hot water appliance is functioning properly.

It is recommended that you have access to a separate power circuit serving only your electronic instant hot water appliance. See previous pages for more information on "ELECTRICAL REQUIREMENTS".

INSTALLATION

Step 1— Position the Instant Hot Water Appliance - DO NOT PLUG IN TANK

Ensure the electronic instant hot water appliance is NOT connected to the Electric Power during installation.

Place the electronic instant hot water appliance in position and check that the instant hot water tap connection pipes and the power cord will reach without being stretched.

The electronic instant hot water appliance must be positioned so the tubes from and to the instant hot water tap do not twist or kink.



INSTALLATION CONTINUED

Once sure the system is water tight dispense, at least 2 quarts of water to remove air from system. Write the installation and filter change dates on the filter label with a permanent ink marker.

19. Ensure that the installation area is dry and no water has spilled. Connect the plug to the power socket and turn on the power socket at the breaker.

The electronic instant hot water appliance display panel will now light up with the on / off button illuminated.

Press the  ON/OFF to control the power.

  Use up or Down buttons to select Temperature desired.

There are 7 preset temperature settings:

208°F maximum

206°F

203°F

194° F

185°F

176°F

167°F minimum

To turn on the electronic instant hot water appliance touch the ON/OFF button and **hold for 3 seconds** until the display lights up.

Press the Plus/Minus buttons and press each time so that the temperature settings will change until the required temperature is seen.

The Actual Temperature will display the approximate water temperature at the thermostat position. When the electronic instant hot water appliance is in heating mode there will be a moving red arc line of lights to indicate the electronic instant hot water appliance is heating up. Once the required set temperature is reached the red arc line will become static. There are two display boxes Heating and Hot when the tank is heating up the Heating light will be lit, and when temperature is achieved this will then light up the Hot display box.

When the instant hot water is drawn from the instant hot water tap or the water temperature falls below a preset level, the unit will automatically reheat to the required temperature setting.

To turn off the electronic instant hot water appliance at any time press the button.

TANK INSTALLATION CONTINUED

11. The electronic instant hot water unit can be mounted on the cabinet interior uses two screws; or, it can be set on the cabinet floor. Please ensure the unit is level prior to operation.

Note:

Every effort is made to prevent damaging the heating unit or thermistor by allowing the unit to run dry. However, if the electronic instant hot water appliance is not immediately powered off and filled with water prior to operation, the warranty will be voided.



Mount on Blue Nipple

12. Connect 3/8 inch copper or PVC tubing to the outlet side of the ShokBloK. The Shok-Blok can go anywhere between the inlet and the filter; wherever is convenient to the installer.



Mount on Red Nipple

16. Connect the outlet side of the ShokBlok to

the inlet side of the Filter Cartridge.

13. From the faucet, connect the 2 lines marked with blue tape, using the "TEE" and sections of pipe to the outlet side of the Filter. **The Blue Marked Lines** are directly under the faucet valves in case the tape has been removed. This provides filtered water to the hot and cold water faucet inlets. Both lines must be connected.

14. Thread the Silver 3/8 inch NPSM x 1/4 inch insert fitting, using a white silicone washer, onto the BLUE nipple on top of the tank.

15. Thread the Silver 3/8 inch NPSM x 5/16 inch Barbed Fitting, using a white silicone washer, onto the RED nipple on top of the tank. This is for the silicone tube.

16. From the Faucet, connect the line marked with red tape, to the Blue Inlet Side of the Tank, with the White 3/8 inch NPSM x 1/4 inch insert Adapter Fitting. **(Red Marked Line (1/4 inch compression) goes to Blue Marked Tank Nipple.)** Please be sure to use the clear silicone washer provided between the fitting and the tank nipple.

17. From the Faucet, connect the Rubber Hose to the Silver Fitting and fasten it with the Hose Clamp. **(Rubber Hose goes to Red Marked Tank Nipple.)**

18. Before the electronic instant hot water appliance is plugged into the power socket it must be tested for water leaks. Open all water supply valves to allow water to flow to the instant hot water faucet. Check for leaks.

To fill the tank, press the hot water lever down and hold it. Wait, holding the lever down, until the faucet dispenses water. It will take about 90 seconds before water starts to dispense from the tap as the tank will have to fill first. When the electronic instant hot water appliance is full, water will flow from the water spout. Allow the hot water handle to return to the off position and check all connections again for watertightness and leaks. Any leaking joint must be tightened to ensure no water leakage and the above priming undertaken again - DO THIS PRIOR TO CONNECTING TO THE POWER OUTLET.

TYPICAL FAUCET INSTALLATION

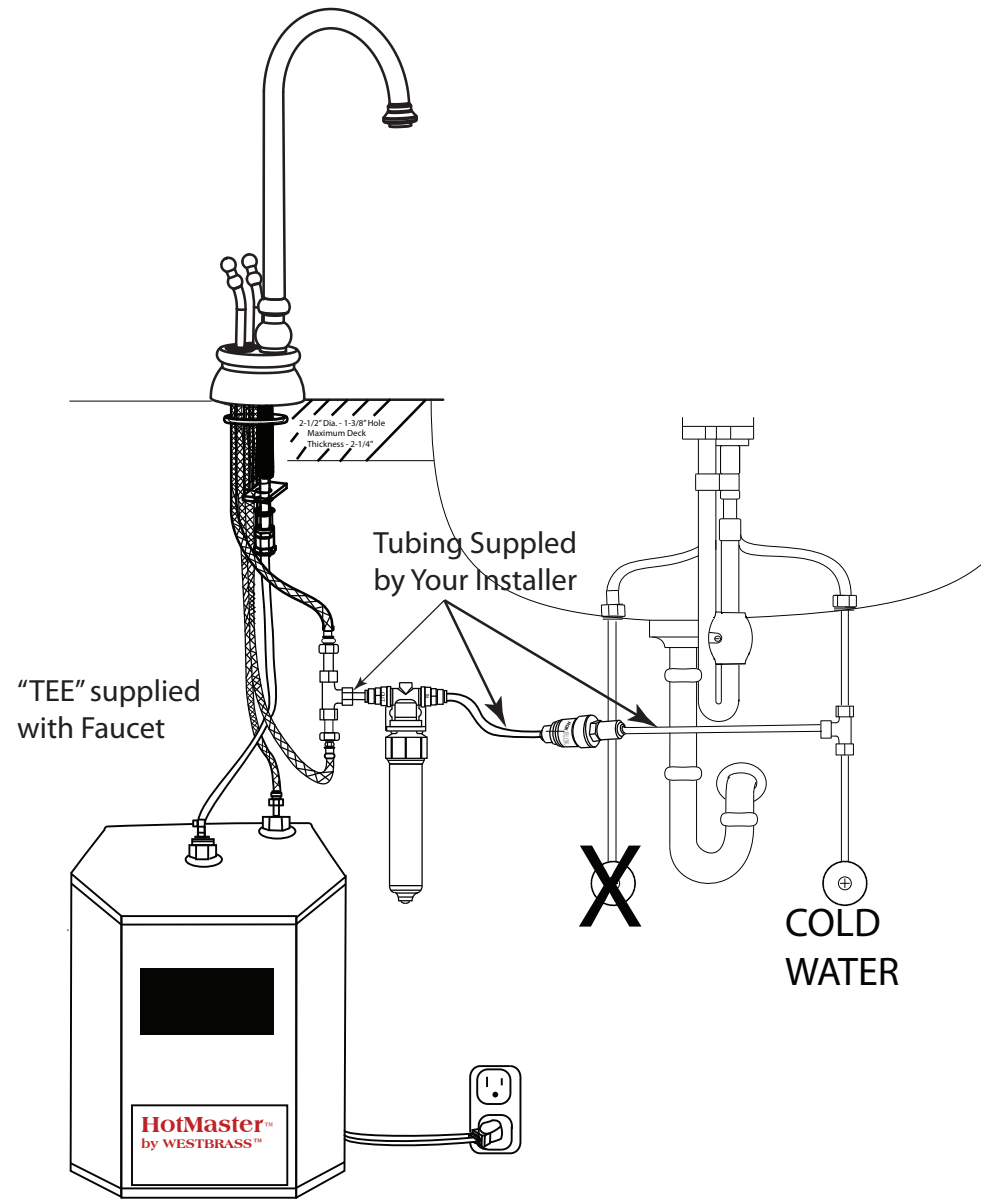

This appliance uses a ShokBlok Water Pressure Limiter between the cold water inlet and the water filter. This pressure limiting device prevents surge pressures from damaging the filter or the faucet itself. The ShokBlok attaches to 3/8 inch copper or hard PVC tubing. Many ways exist to harvest water from the COLD water supply including a Tee as shown above, or a separate valve with its own 3/8 inch compression outlet, neither of which is included in the kit. Please contact your installer for required part and pieces.

FILTER INSTALLATION

1. Remove the filter cartridge from the head works by rotating counter clockwise.
2. Screw the bracket into place, in the required location using screws. Be sure enough clearance is available to remove the filter for replacement. Make sure the mounting lug is pointed upward.
3. Remove the plastic from the filter cartridge. Place the filter in the housing with the open side facing up. It will only fit one way. Tighten the housing onto the top of the unit. Do not lose the O-ring inside of the cap.
4. Tighten filter unit into the head works by turning clockwise. This filter uses a valve inside the cartridge to minimize water leakage when changing filters.
5. Insert 3/8 inch Food Grade PVC or Copper tubing into the inlet of the filter.
6. If using, fit the push fit 'U-clip' fittings into the filter outlets with the flat side down, ensuring that the clip is in place.
7. Remove long nut, washer, and bar from bottom of faucet.
8. Place a thin bead of Silicone seal on the rubber O-ring against the faucet body.
9. Insert Faucet through the desired hole in the sink or counter top.
10. Place bar, and then the long nut on stem and tighten to secure faucet against sink. Do not over tighten.

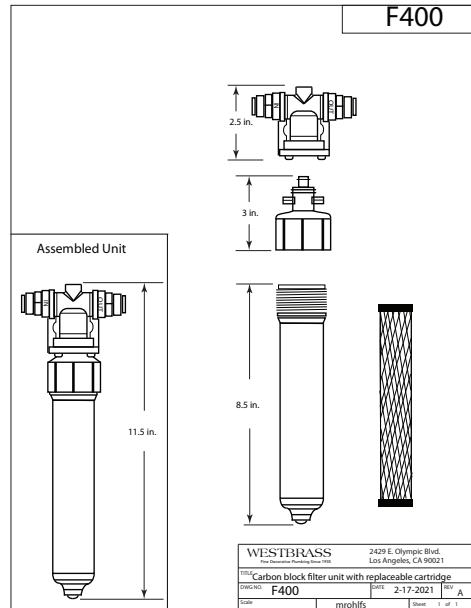

Note: HANDLE SHOULD BE BEHIND THE SPOUT. THE HANDLE CURVE MUST PUSH AWAY FROM THE SPOUT FOR PROPER HANDLE OPERATION AND TO PREVENT SERIOUS BURNS.

WATER SUPPLY INSTALLATION

This appliance uses a ShokBlok Water Pressure Limiter between the cold water inlet and the water filter. This pressure limiting device prevents surge pressures from damaging the filter or the faucet itself. The ShokBlok attaches to 3/8 inch copper or hard PVC tubing. Please contact your installer for the required part and pieces for installation.

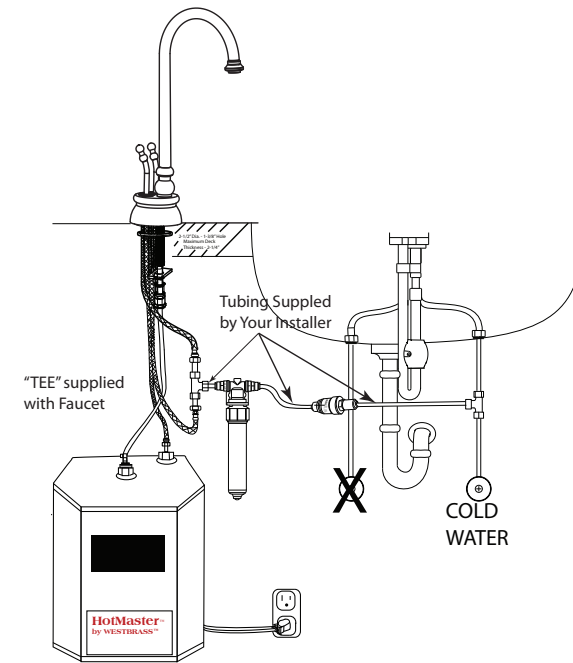

TANK INSTALLATION



WARNING



If the electronic instant hot water appliance is empty of water and is turned ON, this will automatically be sensed by the "Dry Burn Float," which will prevent the heating element from energizing. The "E3" indicator warning code will be flashing on the display panel. If the E3 "lack of water" code is seen, the dry-burn protection sensor has activated automatically due to the lack of water in the electronic instant hot water appliance. Touch the "Power off" button and unplug the tank. Please follow the instructions on how to fill the tank with water, prior to plugging it back in.