



PL

- Zalecamy nie wyrzucać opakowania dopóki nie ukończysz montażu.
- Montażu najlepiej dokonać na miękkiej i czystej powierzchni, takiej jak tekstura, ręcznik, koc.
- Uchroni to przed uszkodzeniem krawędzi mebla.
- Zarówno opakowania plastikowe, jak i okucia trzymaj w miejscu niedostępnym dla niemowląt i dzieci.
- Wszystkie połączenia powinny być odpowiednio dokręcone.
- Przed przystąpieniem do montażu prosimy zapoznać się z całą instrukcją montażu.
- Nie montować elementów, jeśli zauważysz wady lub uszkodzenia.

**PRZED PRZYSTĄPIENIEM DO MONTAŻU SPRAWDŹ, CZY NIE BRAKUJE ŻADNYCH ELEMENTÓW.**



EN

- We recommend not discarding the packaging until assembly is complete.
- Perform assembly on a soft and clean surface, such as cardboard, a towel, or a blanket.
- This will prevent damage to the edges of the furniture.
- Keep both plastic packaging and hardware out of reach of infants and children.
- Ensure all connections are properly tightened.
- Please read the entire assembly manual before starting assembly.
- Do not assemble parts if you notice defects or damage.

**BEFORE STARTING THE ASSEMBLY, CHECK IF ANY PARTS ARE MISSING.**



DE

- Wir empfehlen, die Verpackung nicht zu entsorgen, bevor die Montage abgeschlossen ist.
- Führen Sie die Montage auf einer weichen und sauberen Oberfläche wie Pappe, einem Handtuch oder einer Decke durch.
- Dies verhindert Schäden an den Kanten des Möbelstücks.
- Bewahren Sie sowohl die Plastikverpackungen als auch die Beschläge außerhalb der Reichweite von Säuglingen und Kindern auf.
- Stellen Sie sicher, dass alle Verbindungen festgezogen sind.
- Bitte lesen Sie die gesamte Montageanleitung, bevor Sie mit der Montage beginnen.
- Montieren Sie keine Teile, wenn Sie Mängel oder Schäden feststellen.

**ÜBERPRÜFEN SIE VOR BEGINN DER MONTAGE, OB TEILE FEHLEN.**



ES

- Recomendamos no desechar el embalaje hasta completar el montaje.
- Realice el montaje en una superficie suave y limpia, como cartón, una toalla o una manta.
- Esto evitará daños en los bordes del mueble.
- Mantenga tanto los embalajes de plástico como las piezas fuera del alcance de bebés y niños.
- Asegúrese de que todas las conexiones estén correctamente apretadas.
- Lea todo el manual de montaje antes de comenzar.
- No monte las piezas si nota defectos o daños.

**ANTES DE COMENZAR EL MONTAJE, VERIFICA SI FALTA ALGUNA PIEZA.**



NL

- Wij raden aan de verpakking niet weg te gooien totdat de montage is voltooid.
- Voer de montage uit op een zachte en schone ondergrond, zoals karton, een handdoek of een deken.
- Dit voorkomt beschadiging van de randen van het meubel.
- Houd zowel plastic verpakkingen als beslag buiten het bereik van baby's en kinderen.
- Zorg ervoor dat alle verbindingen goed zijn aangedraaid.
- Lees de volledige montagehandleiding voordat u begint.
- Monteer geen onderdelen als u gebreken of schade opmerkt.

**CONTROLEER VÓÓR DE MONTAGE OF ER ONDERDELEN ONTBREKEN.**



IT

- Si consiglia di non gettare l'imballaggio fino al completamento del montaggio.
- Eseguire il montaggio su una superficie morbida e pulita, come cartone, asciugamano coperto.
- Questo proteggerà i bordi del mobile da eventuali danni.
- Tenere sia gli imballaggi in plastica che la ferramenta fuori dalla portata di neonati e bambini.
- Assicurarsi che tutte le connessioni siano adeguatamente serrate.
- Si prega di leggere attentamente l'intero manuale di montaggio prima di iniziare.
- Non montare i componenti se si notano difetti o danni.

**PRIMA DI PROCEDERE CON IL MONTAGGIO, VERIFICA SE MANCANO DEI PEZZI.**



FR

- Nous recommandons de ne pas jeter l'emballage avant d'avoir terminé le montage.
- Assemblez sur une surface douce et propre, comme du carton, une serviette ou une couverture.
- Cela évitera d'endommager les bords du meuble.
- Gardez les emballages en plastique et les fixations hors de portée des nourrissons et des enfants.
- Assurez-vous que toutes les connexions sont correctement serrées.
- Veuillez lire l'intégralité du manuel d'assemblage avant de commencer.
- Ne montez pas les éléments si vous constatez des défauts ou des dommages.

**AVANT DE COMMENCER LE MONTAGE, VÉRIFIEZ S'IL MANQUE DES PIÈCES.**









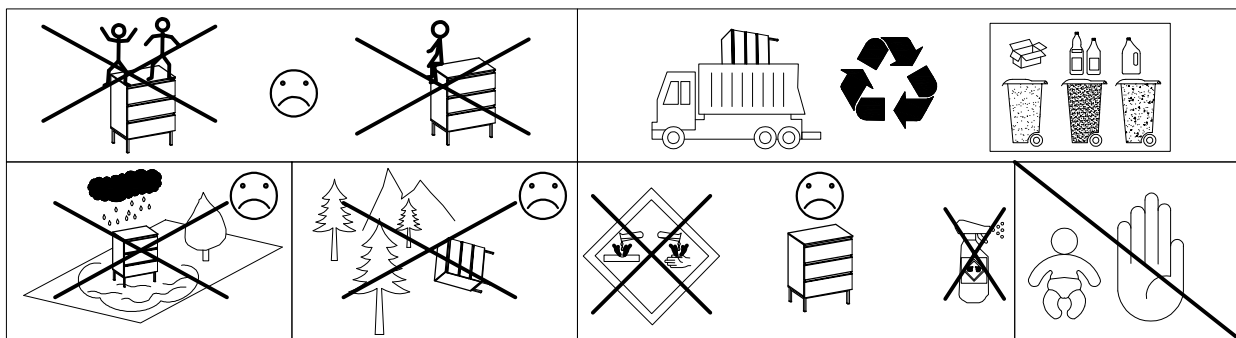



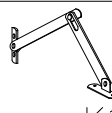
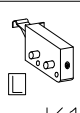

CZ

- Doporučujeme nevyhazovat obal, dokud nedokončíte montáž.
- Montáž provádějte na měkkém a čistém povrchu, jako je karton, ručník nebo deka.
- To zabrání poškození hran nábytku.
- Uchovávejte plastové obaly i kování mimo dosah kojenců a dětí.
- Ujistěte se, že všechny spoje jsou řádně utaženy.
- Před zahájením montáže si prosím přečtěte celý montážní návod.
- Nemontujte díly, pokud zjistíte vady nebo poškození.

**PŘED ZAHÁJENÍM MONTÁŽE ZKONTROLUJTE, ZDA NECHYBÍ ŽÁDNÉ DÍLY.**



 A7 7	 C 6	 D1 6	 B 6	 O 1	 K1 2	 K10 2	 K11 1	 R8 6
 O11 1	 P25 16	 G6 4	 F10 30	 O11 1				

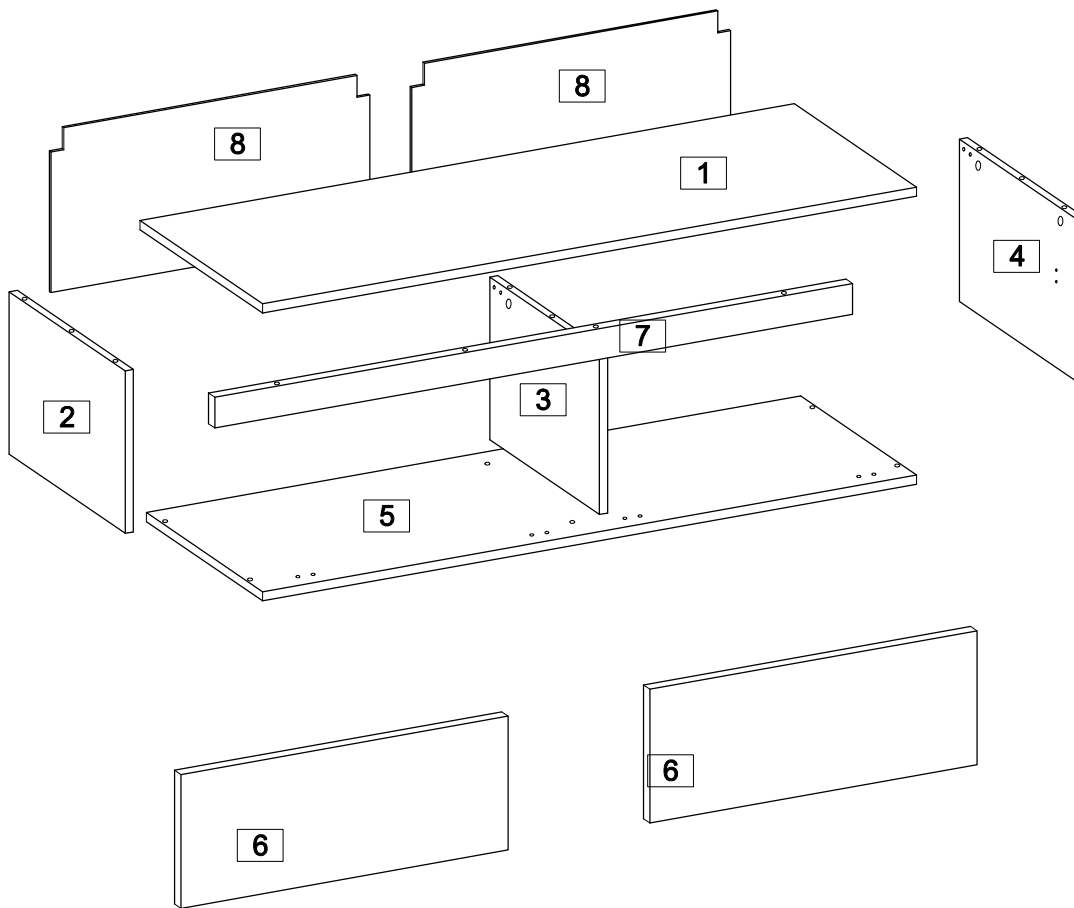

1	2	3	4	5	6	7	8			
1000x318x16 mm	252x300x16 mm	252x279x16 mm	252x300x16 mm	1000x300x16 mm	497x236x16 mm	966x60x16 mm	496x280x3 mm			
1x	1x	1x	1x	1x	2x	1x	2x			

1

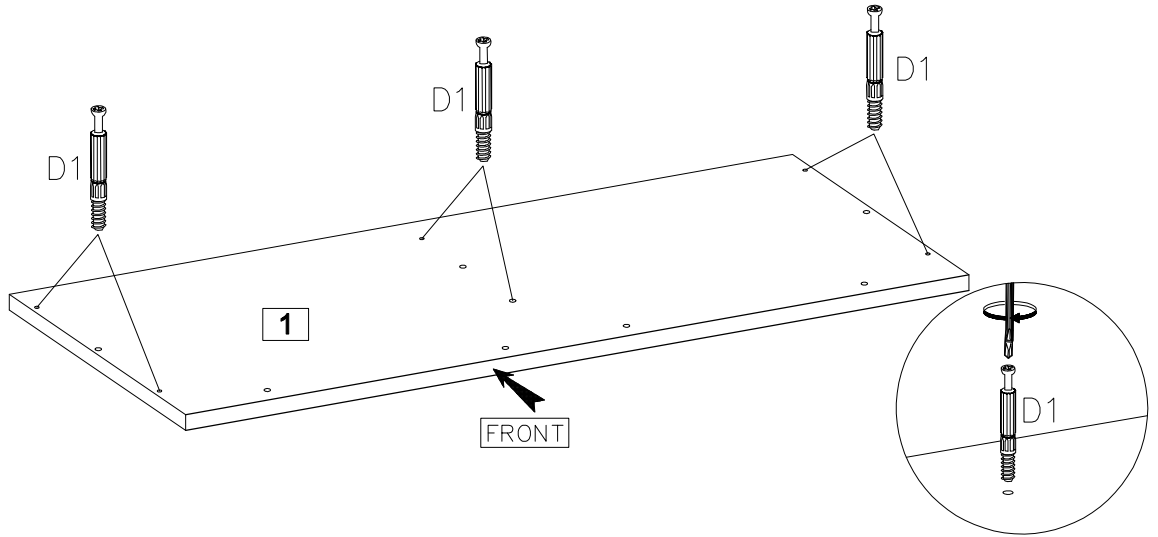
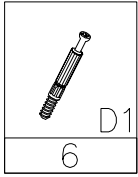

2

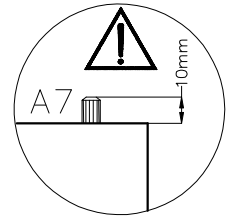
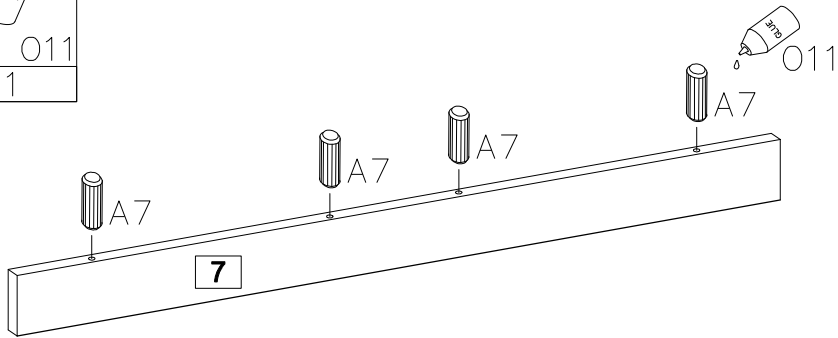
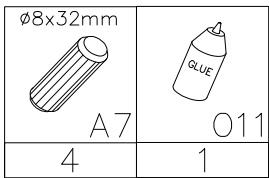

3

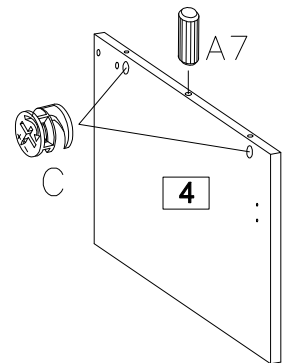
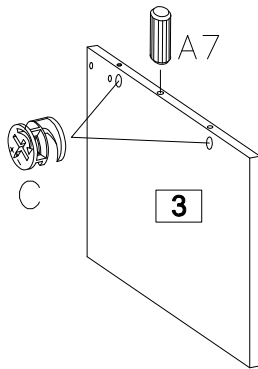
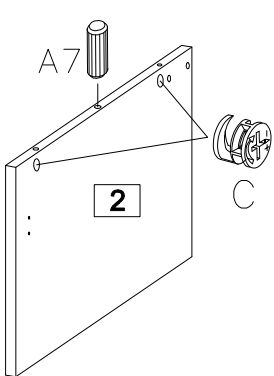
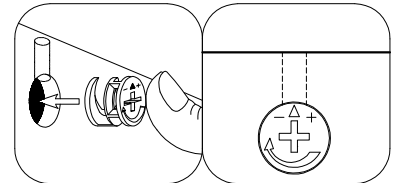
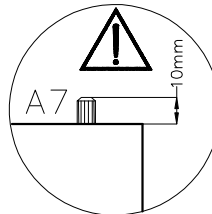
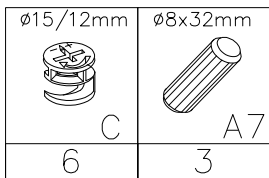

4

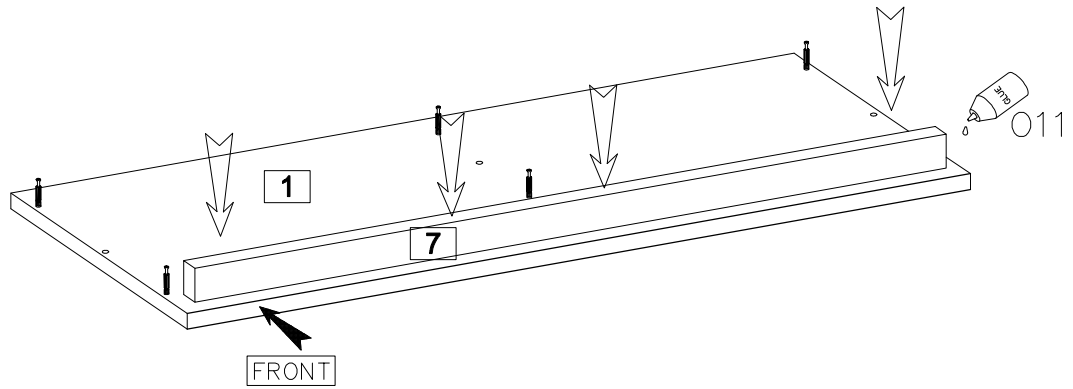
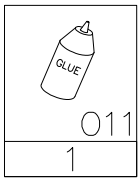

5

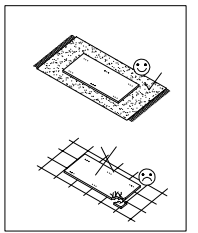
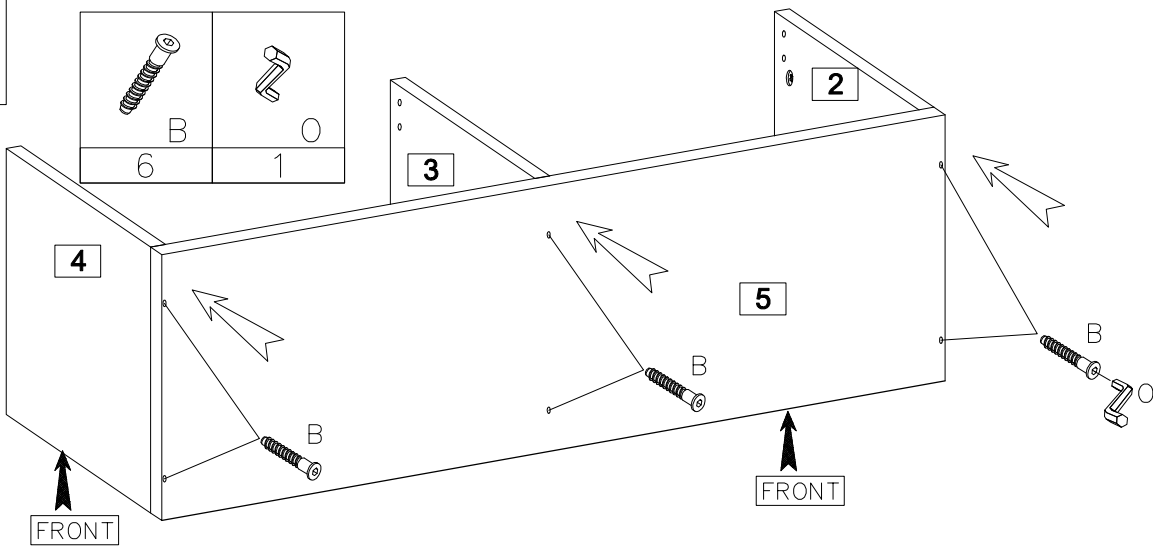
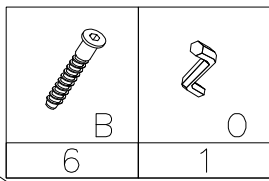

6

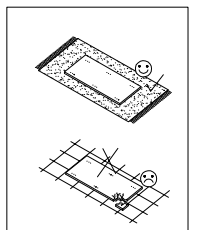
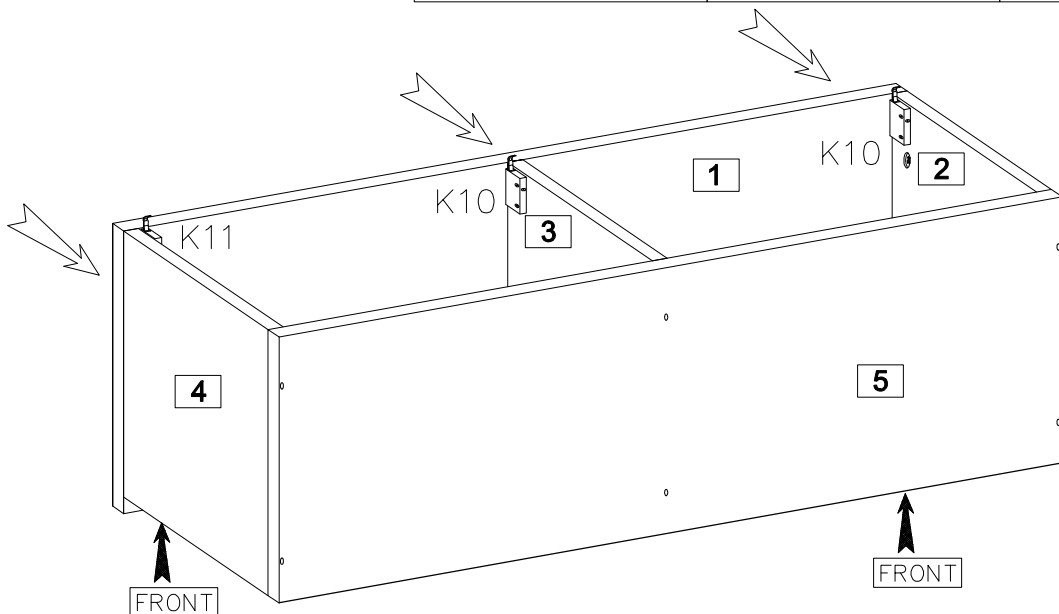
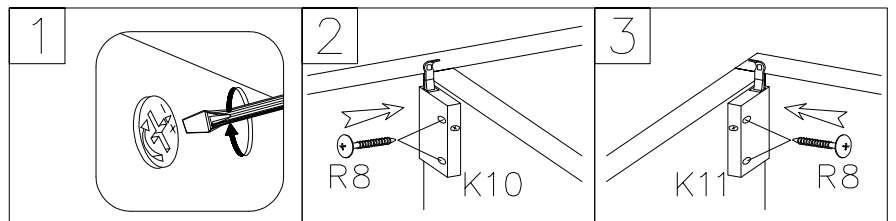
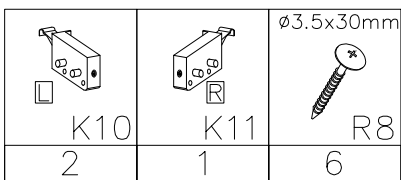

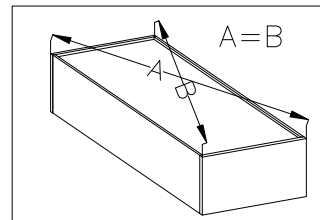
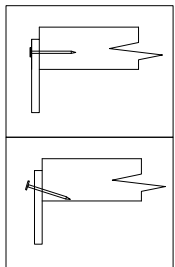
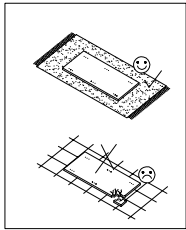
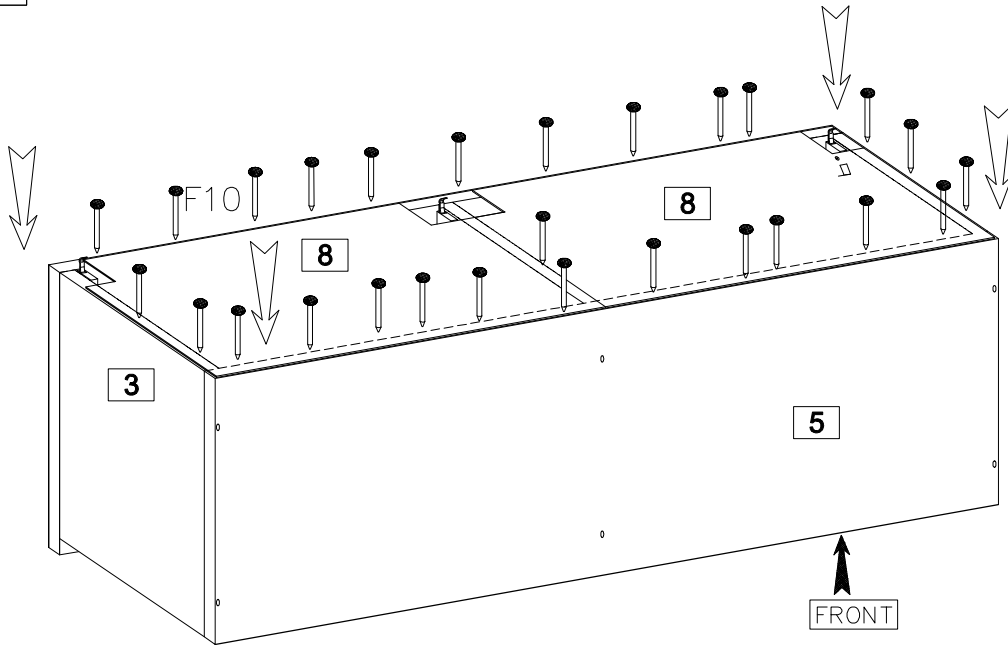
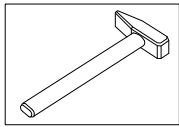
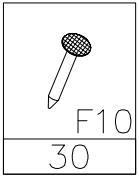
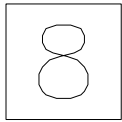

$\varnothing 3.5 \times 15 \text{mm}$	$\varnothing 35 / \text{KR}-0$
P25	G6
8	4

2x

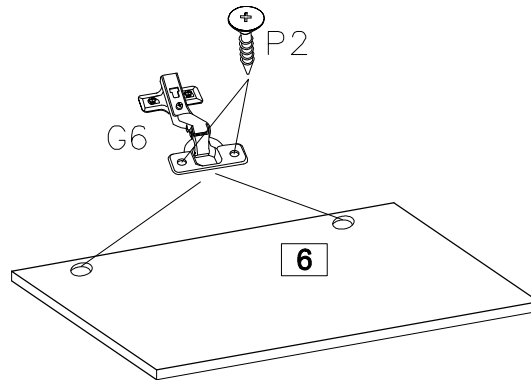

10

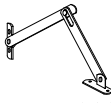
Ø3.5x15mm	
P25	K1
8	2

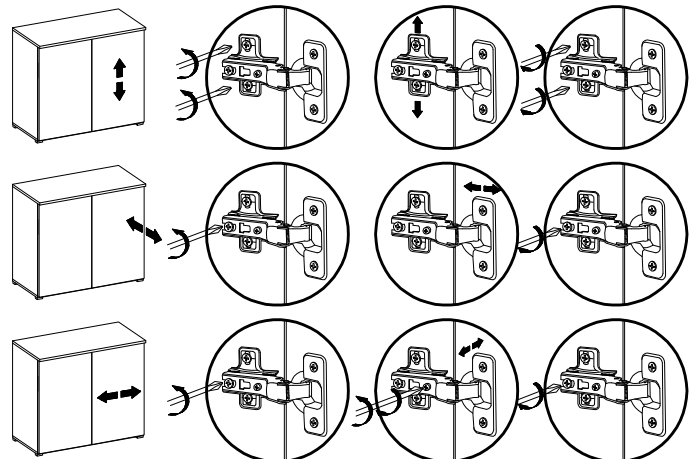
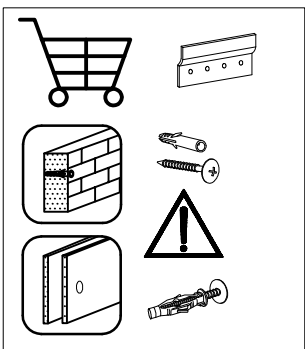
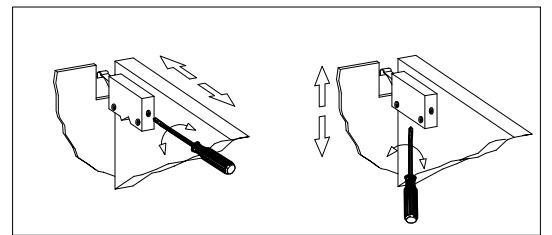
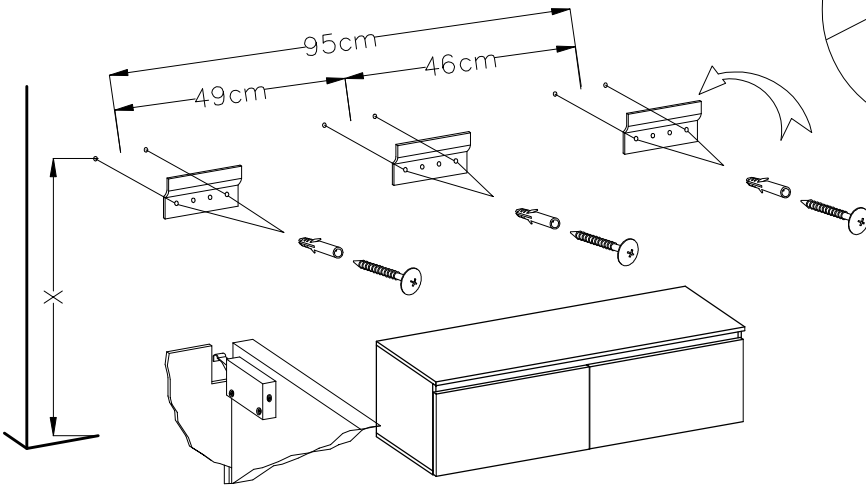
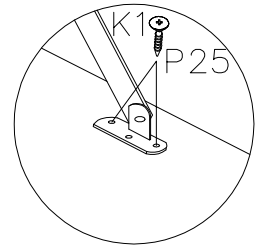
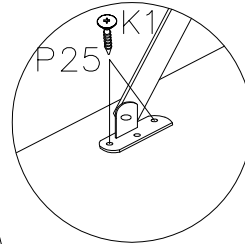
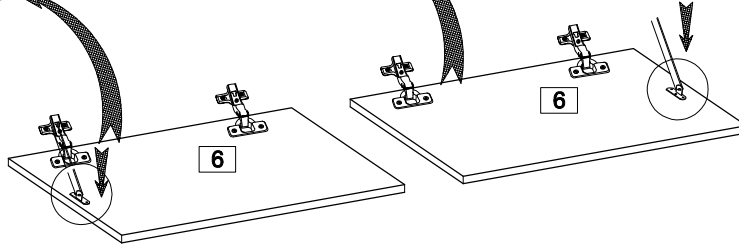
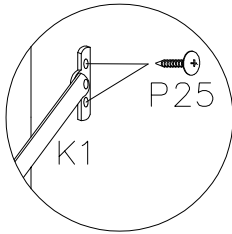
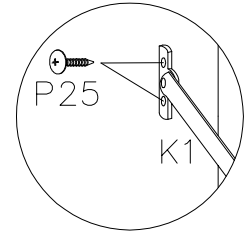
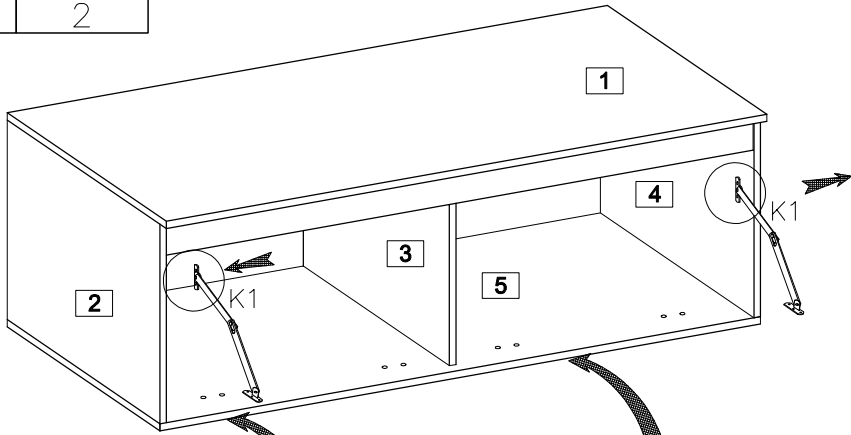
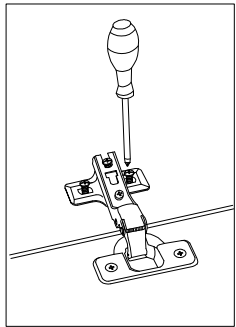

## + Dobrego wnętrza!

Ten produkt został zaprojektowany przez zespół projektantów Selsey Design i wyprodukowany w Polsce.

## + Have a great interior

This product was designed by the Selsey Design team and manufactured in Poland.

## + Ein gutes Zuhause!

Dieses Produkt wurde vom Selsey Design-Team entworfen und in Polen hergestellt.

## + ¡Buen interior!

Este producto fue diseñado por el equipo de Selsey Design y fabricado en Polonia.

## + Een goed interieur!

Dit product is ontworpen door het team van Selsey Design en geproduceerd in Polen.

## + Buon ambiente della casa!

Questo prodotto è stato progettato dal team di Selsey Design e prodotto in Polonia.

## + Un bon intérieur!

Ten produkt został zaprojektowany przez zespół projektantów Selsey Design i wyprodukowany w Polsce.

## + Dobré interiér!

Tento produkt byl navržen týmem Selsey Design a vyroben v Polsku.