

# User Manual

Avery Rattan Pendant Light





WWW.OZARKE.COM

Thank you for shopping with Ozarké, we really appreciate your business. Our goal is to provide an excellent customer service before, during and after delivery. We've included a guide on how to install this light, should you require additional assistance please feel free to email us and one of our customer service reps will reach out to assist you.

You can reach us via email at [info@ozarke.com](mailto:info@ozarke.com) or via phone at +1-(800) 604-7271

## BEFORE YOU GET STARTED

**When working with electrical wiring, follow these safety instructions to prevent injury or damage:**

1. Turn off the power: Before starting any work, turn off the power to the area you will be working in.
2. Use appropriate tools: Only use tools designed for electrical work and in good condition.
3. Wear protective gear: Wear safety glasses, gloves, and other protective gear as necessary.
4. Test for power: Use a non-contact voltage tester to check for electrical current before touching any wires.
5. Avoid wet conditions: Do not work with electrical wiring in wet or damp conditions.
6. Keep a safe distance: Stay away from exposed wires or electrical components.
7. Seek professional help: Consult a qualified electrician if you are unsure about any aspect of electrical wiring or encounter any problems.



## WARNING!

1. Do not use the power supply beyond the specified range (100-240V).
2. Avoid scratching the surface and wires of the light during installation.
3. Do not install the light outdoors.
4. The light should not be close to corrosive chemical objects or gases.
5. It should not be washed with water. It can only be wiped with a clean soft cloth.



# HX2005 PENDANT LAMP,NATURAL





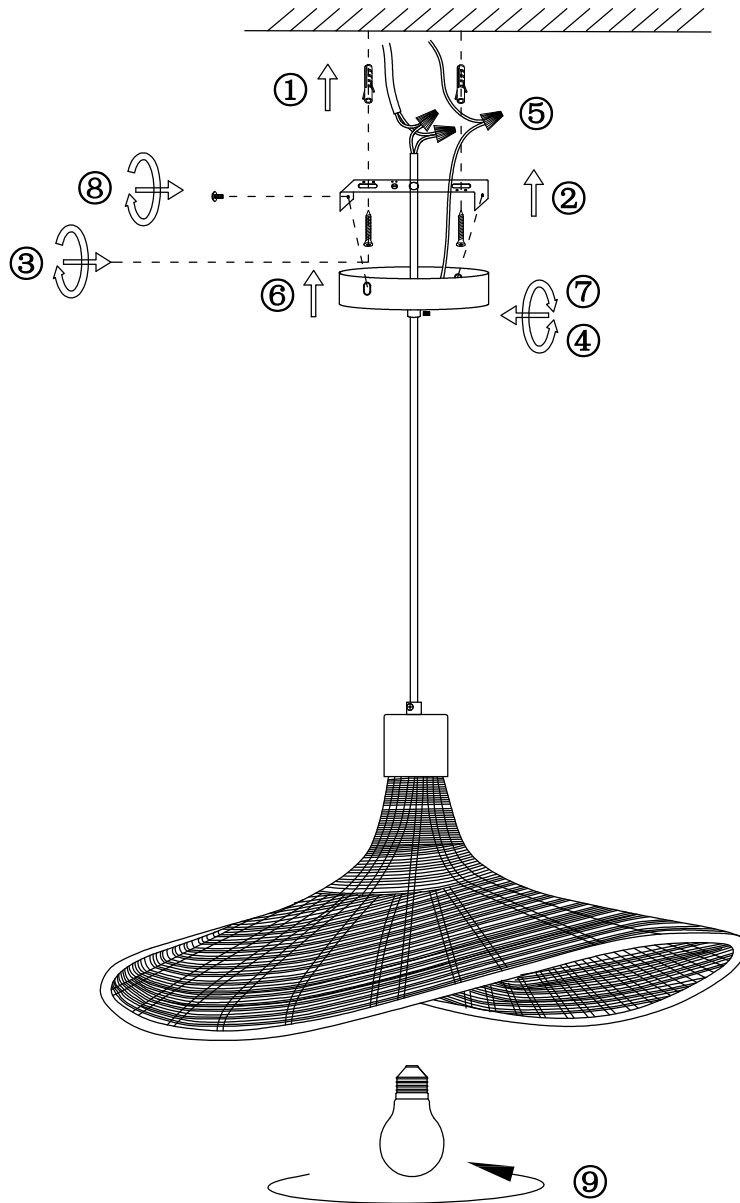
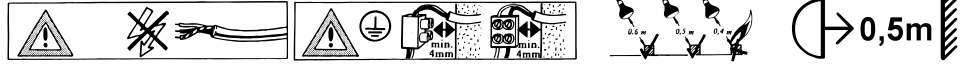

(DE) Montageanleitung

(EN) Mounting instructions





(BiH/HR/SR/CG) Upute za montiranje







**(DE) Sicherheitshinweise / Bitte lesen Sie diese Informationen sorgfältig durch, bevor Sie mit der Installation oder Inbetriebnahme dieses Produkts.**

1. Die Leuchten dürfen nur von autorisiertem Fachpersonal nach den jeweils geltenden Elektro-Installationsvorschriften installiert werden.
2. Der Hersteller übernimmt keine Verantwortung für Verletzungen oder Schäden, die Folge eines unsachgemäßen Gebrauchs der Leuchte sind.
3. Die Pflege von Leuchten beschränkt sich auf die Oberflächen. Dabei darf keine Feuchtigkeit in Anschlussräume oder an Netzspannung führende Teile gelangen.
4. Achtung! Vor Beginn der Montagearbeiten die Netzleitung spannungsfrei schalten – Sicherungsautomat ausschalten bzw. Sicherung heraus drehen. Schalter auf "AUS".
5. Die Leuchte besitzt den Schutzgrad IP20, abgedeckte Ausführung nach IEC 529 und ist nur zur Verwendung im Wohnbereich geeignet.
6. Schutzklasse I (⊕). Diese Leuchte muss mit dem Schutzleiter (grün - gelbe Ader) an der Schutzleiter - Klemme (⊕) angeschlossen werden.
7. Bezeichnung der Anschlussklemmen: L = Phase N = Neutraleiter (⊕) = Schutzleiter.
8. Es dürfen ausschließlich mitgelieferte Einzelteile verwendet werden, da sonst jegliche Gewährleistungsansprüche erlöschen.
9. Stellen Sie sicher, dass Leitungen bei der Montage nicht beschädigt werden.
10. Achtung! Leuchtenteile und Leuchtmittel können während des Betriebs Temperaturen von >350°C erreichen und dürfen daher während des Betriebs nicht berührt werden.
11. Defekte Leuchtmittel dürfen nur durch Lampen gleicher Bauart, Leistung und Spannung ersetzt werden.
12. Die angegebene maximal – Wattzahl jeder Brennstelle darf nicht überschritten werden.
13. Das Einstellen und Ausrichten der Leuchte darf nur im abgekühlten Zustand erfolgen.
14. (P) 0,5m Minimumabstand von Strahlerkante zur angestrahlten Fläche >= 0,5 m.
15. Halogen - Lampen  nicht mit bloßen Fingern berühren.
16.  Nur Halogenleuchtmittel mit Abdeckscheibe oder in Niederdrucktechnik verwenden.
17.  Bei diesem Zeichen dürfen keine "cool beam" – Leuchtmittel eingesetzt werden.
18.  Ein zerbrochenes Schutzglas ist sofort zu ersetzen.

**(EN) Safety directions / Please read this information carefully before installing or using this product.**

1. The lamps may only be installed by authorized and qualified technicians according to the valid regulations for electrical installation.
2. The manufacturer does not accept any responsibility for injuries or damage resulting from improper use of the light.
3. Maintenance of the lights is limited to the surfaces. When doing this, no moisture must come into contact with any areas of the terminal connections or mains voltage control parts.
4. Attention! Before starting the installation work, make sure that the mains power line is voltage-free – turn off safety cutout or unscrew the protection fuse. The switch must be "OFF".
5. The light has the protection degree IP20, covered design in accordance with IEC 529 and is only suitable for use in living areas.
6. Safety class I (⊕). This light must be connected to the earthed conductor-terminal with the earthed conductor (green-yellow wire) (⊕).
7. Description of the supply terminals: L = Phase N = Neutral conductor (⊕) = Earthed conductor.
8. Only the included individual parts may be used; otherwise any and all guarantee claims will expire.
9. Please make sure that no cables get damaged during the installation work.
10. Attention! During operation, lamp parts and illuminants can reach temperatures of more than 350°C. Do not touch during operation!
11. Faulty illuminants may only be replaced by lamps of the same type, output and voltage.
12. The maximum wattage indicated of each lighting unit must not be exceeded.
13. The lamp may only be adjusted and positioned after having cooled down.
14. (P) 0,5m Minimum distance from the edge of the spotlight to the illuminated surface >= 0.5 m.
15. Do not touch halogen lamps  with bare fingers.
16.  Only use halogen illuminants with a covering pane or in low-pressure technology.
17.  With this symbol, no "cool beam" illuminant must be used.
18.  Broken protective glass must be replaced immediately.

**(BiH/HR/SR/CG) Sigurnosne upute / Molimo vas da ovo pažljivo procitate prije instaliranja i upotrebe ovog proizvoda.**

1. Postavljanje i instalaciju može vrsiti samo ovlašteno i kvalificirano lice, prema vazecim propisima elektricne instalacije.
2. Proizvođjac ne prihvata bilo kakvu odgovornost za ozljede ili oštećenja nastale prilikom nepravilne upotrebe rasvjete.
3. Održavaju se samo površinski dijelovi rasvjete. Prilikom održavanja, vlaga ne smije biti u kontaktu sa kontaktima i ostalim elektricnim dijelovima.
4. Paznja! Prije postavljanja, budite sigurni da nema dovoda struje, prekidač je u 'OFF' poziciji, i glavni dovod struje i osiguraci moraju biti isključeni.
5. Stepen zaštite ove rasvjete je IP20, pokrivena površina su u skladu sa IEC529 regulativom i prikladne su za sobe i dnevne boravke.
6. Klasa sigurnosti 'I' - ova rasvjeta se može priključiti na uzemljenje preko kabla za uzemljenje (zeleno-zuti provodnik).
7. Opis pripadajućih provodnika: L = Faza, N = Nula, (⊕) = Uzemljenje.
8. Samo pripadajući originalni dijelovi se mogu koristiti, u protivnom se gubi garancija.
9. Please make sure that no cables get damaged during the installation work.
10. PAZNJA! Tokom rada, sijalice i rasvjetna tijela mogu dostići temperature preko 350°C. Ne dodirivati prilikom rada!
11. Neispravne i pregorjele sijalice se mogu zamijeniti samo sa istom sijalicom, iste snage i napona.
12. Maksimalna snaga je oznacena na svakoj sijalici, i ne smije se prekoračiti.
13. Lampe se mogu podesavati i pomjerati samo nakon što su ugasene i ohladjene.
14. (P) 0,5m Minimumalni razmak od ruba lampe do površine koju osvjetljuje >= 0.5 m.
15. Ne dirati halogene sijalice  sa golim prstima.
16.  Samo koristiti halogene sijalice sa poklopcem ili sa nisko-tlačnom tehnologijom.
17.  Ako je prikazan ovaj simbol, to znaci da se "cool beam" sijalice ne smiju koristiti.
18.  Polomljeno zastitno staklo se mora odmah zamijeniti.

