

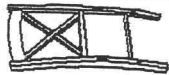









# ASSEMBLY INSTRUCTIONS

Read instruction carefully . Be sure you have all parts before you start assembling (see PART LIST & HARDWARE LIST) . To avoid scratching , lay the parts on a clean soft area such as carpet or rugs . Do not tighten all screws unless is instructed .

## PARTS LIST

NO	DESCRIPTION	QTY	NO	DESCRIPTION	QTY
1	CHAIR BACK 	1 PC	4	SIDE APRON 	2 PCS
2	CHAIR FRONT LEG 	1 PC	5	STRECHER 	2 PCS
3	CHAIR SEAT 	1 PC			

## HARDWARE LIST

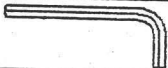
NO	DESCRIPTION	QTY	NO	DESCRIPTION	QTY
A	JCBC SCREW 50MM 	4 PCS	D	SCREW 38MM 	4 PCS
B	SPRING WASHER 	4 PCS	E	SCREW 32MM 	3 PCS
C	FLAT WASHER 	4 PCS	F	ALLEN KEY 	1 PC

## FULLY SET UP

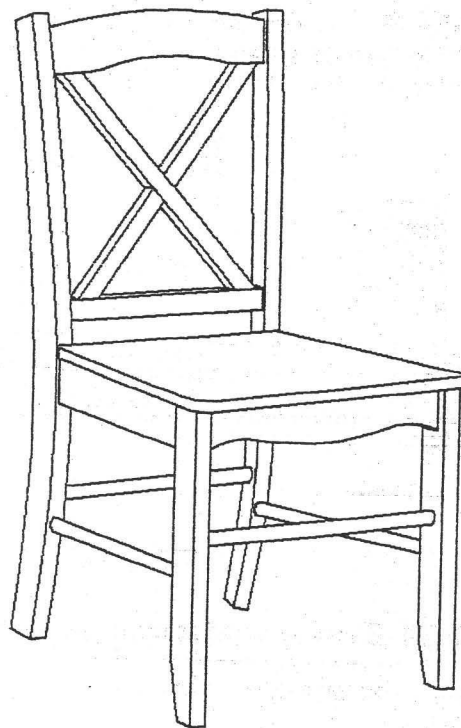

# ASSEMBLY INSTRUCTIONS

## STEP 1

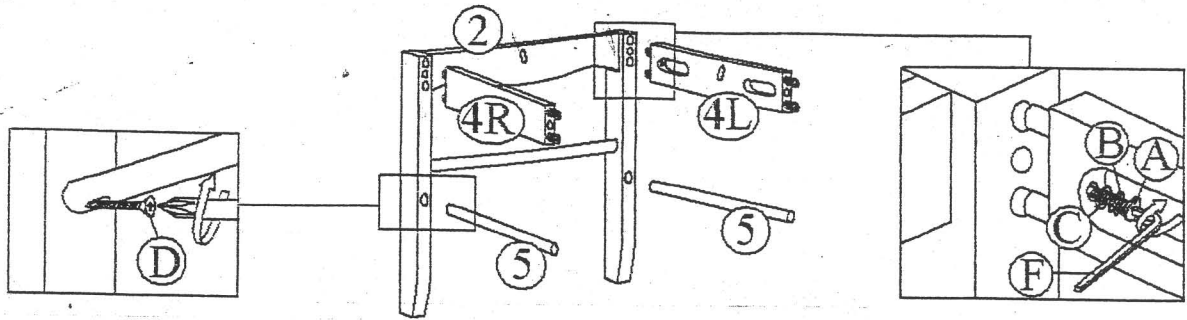

Use allen key (F) , JCBC screw 50MM (A) , spring washer (B) and flat washer (C) to assemble left and right side apron (#4L & 4R) to chair front leg (#2) .

Use philips screw driver and screw 38MM (D) to assemble both stretchers (#5) to chair front leg (#2) .  
Do not tighten screws .

## STEP 2

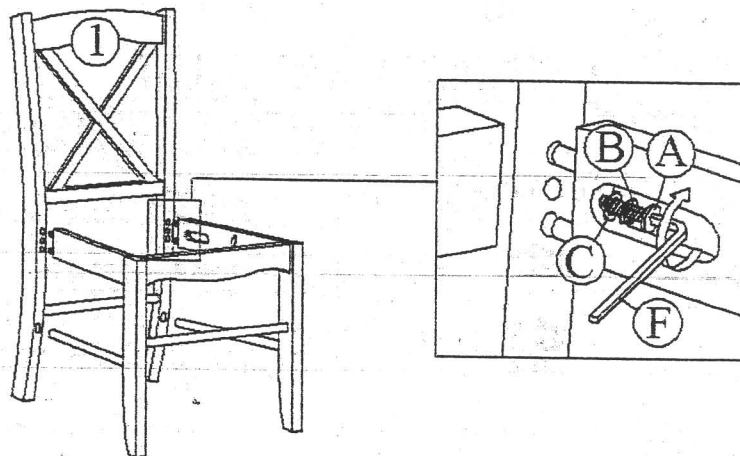

Use allen key (F) , JCBC screw 50MM (A) , spring washer (B) and flat washer (C) to assemble left and right side apron to chair back (#1) . Tighten all screws .

## STEP 3

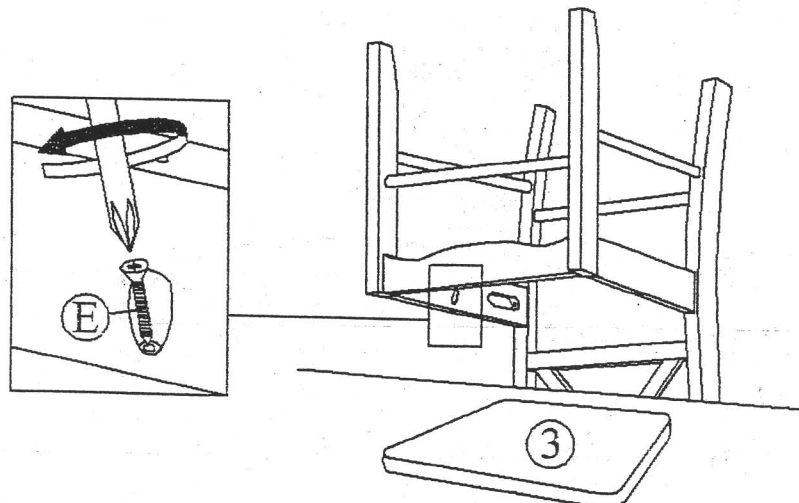

Use philips screw driver , screw 32MM (E) to assemble chair seat (#3) to seat . Tighten the screw .

After few days of initial assembly , the product may have acclimated to new environment , please retighten all hardware again .